



# FITTINGS CATALOGUE 2026



# INTRODUCTION

**“At Ryco we design, manufacture, and supply premium quality and cutting-edge fluid transfer products, and solutions for a large range of industries around the world.”**



Our experienced Research & Development team take 2D drawings to 3D models to real life products.



Our world-class hoses, fittings and assembly equipment are manufactured in-house to the highest standards.



We test and validate our products to meet and exceed technical industry standards.



We provide the complete solution: hoses, fittings, crimping parameters and assembly equipment for a fully integrated system.



We supply fluid conveyance solutions directly to our customers whenever and wherever they are.

Ryco Hydraulics started manufacturing hoses and fittings in 1946. As the hydraulics industry evolved, the company expanded its range, and the main product line soon became high-pressure hydraulic hose and fittings. Today, Ryco Hydraulics is known for its engineering excellence, customer-focus, and highest quality products which continue to attract new customers, from varied industries right across the world.

With a comprehensive range of hydraulic hoses, hydraulic couplings, industrial hoses, and assembly equipment, Ryco is a global leader in designing, manufacturing, and distributing fluid transfer solutions.

Ryco Hydraulics' products not only meet but exceed industry standards, ensuring maximum performance and reliability. From open-pit and underground mining, to construction, agriculture, marine, forestry and oil & gas industries, our hose assemblies are trusted by clients worldwide.

Whether it's our hoses, fittings, or assembly machines, at Ryco Hydraulics we do more than simply supply a product; we understand our success is dependent on our clients' success, safety, and quality.

With a global presence and a focus on local service, we are dedicated to empowering various industries with reliable, high-performance fluid products and systems tailored to our customer's unique needs.



## EXCEPTIONAL PERFORMANCE

Designed to deliver exceptional performance and reliability, Ryco fittings are meticulously crafted to meet or exceed international standards, ensuring the highest level of quality.

Trusted by clients in the mining, construction, agriculture and marine sectors, to name just a few, Ryco hydraulic fittings are built for maximum performance, reliability, and safety.

**One-Piece Crimp Fittings** - are permanently attached fittings, assembled onto the hose with a crimping machine.

- **T2000** One-Piece Crimp Fittings are designed for use with 1 and 2 wire braid hose types.
- **T4000** One-Piece Crimp Fittings are designed for use with 1 and 2 textile braid hose types.
- **T6000** One-Piece Crimp Fittings are designed for use with wire spiral hose types
- **T7000** One-Piece Crimp Fittings are designed for use with 1 and 2 wire braid and wire spiral hose types.
- **TP000** One-Piece Crimp Fittings are designed for use with thermoplastic hose types.
- **TT000** One-Piece Crimp Fittings are designed for use with Teflon(R) hose types.
- **TG000** One-Piece Crimp Fittings are designed for use with greasing hose types.
- **TW4000** One-Piece Crimp Fittings are designed for use with high-pressure water-blast hose types.

**Push-On & Suction & Return Fittings** - are field-attachable fittings, designed for low pressure or suction applications.

- **8000 Series Push-On** Hose Fittings are field-attachable fittings, designed for low pressure applications.
- **33000 Series Suction & Return** Hose Fittings are field-attachable fittings, designed for low pressure or suction applications

**Field Attachable Fittings** - are attached to the hose using commonly available hand tools.

- **Ryco 6000 Field Attachable** system consist of five ferrule styles, each specific to a hose type, and common Insert.
- **Ryco Field Attachable Inserts** and Ferrules can be ordered individually, or as a complete coupling for specific hose types.

# INTRODUCTION

## INNOVATION

Ryco Hydraulics R&D activities are based at the Manuli Ryco Innovation Centre (MRIC) based in Bologna, Italy, from where it coordinates four specialized centres located in China, Poland, France, and the United Kingdom. All of our research centres are equipped with advanced design, testing, and validation facilities.

From design and manufacturing to assembly, our integrated philosophy makes us the trusted global leader in fluid and material transfer solutions. Our unwavering commitment to performance, safety, and sustainability ensures that customers receive cutting-edge products tailored to their needs.

Our global R&D teams are made up of highly skilled international engineers who are dedicated to the development of integrated solutions for Ryco customers. The quality, wide selection of products, and cost saving initiatives that our Innovation Centres provide allow us to better support our customers whatever their requirements.

## CERTIFIED PLANTS

Ryco Hydraulics is committed to environmental, health & safety and quality operational methods worldwide. We activity update our plant certifications to ensure we not only but exceed industry standards.

For information concerning our certified plants, please visit: [www.ryco-hydraulics.com/plant-approvals/](http://www.ryco-hydraulics.com/plant-approvals/)



## SAFETY GUIDE: DON'T MIX & MATCH

Ryco hose and fitting products must be assembled in strict accordance with Ryco instructions and limitations. Don't mix and match: always use Ryco original hoses and fittings. Ryco hose, fittings, and assembling machines are tested as an effective and reliable system. The use of different products and machines will affect and nullify any representation and/or warranty on products, their features and/or performance that may have been provided, and may cause premature hose failures, property damage, serious injury or death for which Ryco does not assume any responsibility and/or liability at any title whatsoever. Inside our Digital Crimp Tools, you can find the only official technical crimping parameters relating to our products and/or services. Therefore, please be sure to use the latest version of our Crimp App and Web Tool.

RYCO MAKES NO REPRESENTATIONS AND/OR WARRANTIES, EXPRESS OR IMPLIED, AND ASSUMES NO RESPONSIBILITY AND/OR LIABILITY FOR ANY LOSS OR DAMAGE, WHETHER DIRECT, INDIRECT, CONSEQUENTIAL OR INCIDENTAL WHICH MIGHT ARISE OUT FROM, OR IN CONNECTION WITH, IMPROPER AND/OR INCORRECT USE OF ITS PRODUCTS AND/OR ASSEMBLY EQUIPMENT OR FROM ANY USE OF CRIMPED HOSE ASSEMBLIES NOT PRODUCED FROM GENUINE RYCO HOSE FITTINGS, HOSE AND EQUIPMENT, AND, IN GENERAL, NOT IN ACCORDANCE WITH OUR PROCESS SPECIFICATIONS FOR EACH SPECIFIC PRODUCT AND/OR ASSEMBLY EQUIPMENT.

## DISCLAIMER

We reserve the right to modify our products and/or related services and/or discontinue the manufacture and/or supply of any of the products and/or related services, without notice. No product is warranted as being fit for a particular purpose and we do not assume any liability in connection with the use of our products other than those technically approved in writing by us, or specified in the relevant official technical specifications released by us, for specific products. This document supersedes all previous versions and previously issued documentation. The only official source of technical crimping parameters regarding our products is our Digital Crimp Tools. Printed copies are uncontrolled therefore, please be sure to use the latest versions of our [Ryco Crimp App](#) or visit our [Crimp Web Tool](#). For more information, please visit our dedicated 'Contact' page on the [Ryco's website](#).



INTRODUCTION

INDEXES

ONE-PIECE COUPLINGS

PUSH-ON SUCTION & RETURN COUPLINGS

FIELD ATTACHABLE COUPLINGS

HYDRAULIC FITTINGS ACCESSORIES

# INTRODUCTION



Contents.....	1
Information.....	2-4
Pictorial index.....	5-14
Index by end style number.....	15-19
Working pressure of hose assemblies.....	20
<b>RYCO ONE PIECE CRIMP COUPLINGS</b>	
<b>T2000</b> Series One-Piece Crimp Couplings.....	21
<b>T4000</b> Series One-Piece Crimp Couplings.....	78
<b>T6000</b> Series One-Piece Crimp Couplings.....	100
<b>T7000</b> Series One-Piece Crimp Couplings.....	131
<b>TP000</b> Series One-Piece Crimp Couplings.....	174
<b>TT000</b> Series One-Piece Crimp Couplings.....	191
<b>TG000</b> Series One-Piece Crimp Couplings.....	198
<b>TW000</b> Series One-Piece Crimp Couplings.....	201
<b>RYCO PUSH-ON &amp; SUCTION &amp; RETURN COUPLINGS</b>	
<b>8000</b> Series Push-On Couplings.....	202
<b>33000</b> Series Suction and Return Couplings.....	210
<b>RYCO FIELD ATTACHABLE COUPLINGS</b>	
<b>V000</b> Series Field Attachable Couplings.....	218
Additional coupling end styles.....	218
Cut-off allowance (CA) dimensions for field attachables.....	218
How to order Ryco V Series field attachable couplings.....	219
6000 Series field attachable inserts.....	238-273
<b>HYDRAULIC FITTINGS ACCESSORIES</b>	
SAE flange clamps.....	274
<b>INDEX</b> .....	284

**THIS SECTION IS ARRANGED IN THE FOLLOWING COUPLING SERIES ORDER:**

PAGES	COUPLING SERIES	APPLICATION
<b>ONE-PIECE CRIMP COUPLINGS</b>		
21 to 77	<b>T2000</b>	One-Piece Crimp for Wire Braid Hose T3000D, T3000S, T3600D, T3600S, T4000D, T4000S, T5000D, T5000S, T6000D, T6000S, DF1D, DF2D, DK1D, DK1E, DK1S, DK2D, DK2E, DK2S, EC1, EC2, E1, E2, T1D, T1F, T1S, T2D, T2S, T2C, TXA2D, SURVIVOR/1, SURVIVOR/2, TW1, PW2, BT1, TJ2D, CS1000, JS4000, JS6000 and MS1000.
78 to 99	<b>T4000</b>	Suction & Return – SRF/P, SRX/HT. Speciality & High Temperature – T5, SURVIVOR/R5. Textile Braid – M2, M2G, MP1, PL1D, PL1PV.
100 to 130	<b>T6000</b>	ISOBARIC Spiral – H5000D/S/C, H6000D/S.
131 to 173	<b>T7000</b>	ISOBARIC Spiral - H3000D/S, H4000D/S, H5000D/S/C, H6000D/S, C6000D, H12D/S, R4SPD, R4SHD. Braid – E2, T2D/C, TXA2D, Speciality & High Temperature – D2B, SURVIVOR/2.
174 to 190	<b>TP000</b>	Thermoplastic – TP7, TP7N, TP7T, TP7TN, TP8, TP8N, TP8T, TP8TN, TP3000.
191 to 197	<b>TT000</b>	TEFLON® - RTH1.
198 to 200	<b>TG000</b>	GREASELINE - TPGL.
201	<b>TW4000</b>	SHOCKWAVE

<b>FIELD ATTACHABLE COUPLINGS &amp; ACCESSORIES</b>		
202 to 209	<b>8000</b>	Textile Braid – PL1D, PL1PV.
210 to 217	<b>33000</b>	Suction & Return – SRF/P, SRX/HT.
220 to 237	<b>6000 &amp; V000</b>	Speciality & High Temperature – SURVIVOR/R5, T5.
238 to 273	<b>6000 &amp; K000, L000, M000, P000</b>	Braid – E1, E2, T1D, T1F, T2D, TXA2D. Speciality & High Temperature – BT1, SURVIVOR/1, SURVIVOR/2. Textile Braid – M2, M2G. GREASELINE - TPGL.
274 to 282	<b>SAE Adaptors</b>	SAE Adaptors, Flanges & Flange Blocks.

<b>TWO INDEXES FOLLOW:</b>		
5 to 14	—	Pictorial Index.
15 to 19	—	Index by End Style Number & Coupling Series.

WITHIN EACH COUPLING SERIES THE LISTING ORDER IS ALPHABETICAL\* BY THREAD OR CONNECTOR TYPE:

- BSP (BSPT, BSPP, BSPO, BSPP ENCAPSULATED SEAL, BSPP O RING, BANJO)
- NPT\* (NPT, NPTF, NPSM)
- GREASELINE
- JSEAL™ / JIC
- JIS (BSP, METRIC)
- JOINER
- METRIC (DKL, DKOL, DKS, DKOS, JIS, BANJO)
- ORFS
- PW
- RYCOLOK, SUPERLOK
- RYCO WEO
- SAE (Thread, then Flange)
- SALVAGE
- STANDPIPE
- TUBE BITE
- UNO (O RING BOSS)
- Hammer Union (wing union)

\*NOTE: NPT is not in strict alphabetical order. NPT is similar in concept to BSP therefore has been placed directly after BSP.

WITHIN EACH ALPHABETICAL THREAD OR CONNECTOR TYPE, THE LISTING ORDER IS:

- MALE
- FEMALE
- SPECIAL FEATURES (live swivel, etc)
- SPECIAL SEATS (flat, concave, etc)
- ELBOWS (45° then 90°)
- TUBE BENDS (in increasing degree of bend from 10° to 110°)

INTRODUCTION

INDEXES

ONE-PIECE COUPLINGS

PUSH-ON SUCTION & RETURN COUPLINGS

FIELD ATTACHABLE COUPLINGS

HYDRAULIC FITTINGS ACCESSORIES

# INTRODUCTION

## INFORMATION

Ryco Hydraulics manufacture hose couplings in many different styles and sizes to match each Ryco hose series, with a wide range of thread and connection types.

Hose Couplings must be carefully matched to the hose. When the hose for an application has been selected, it is crucial that the couplings to be fitted are designed specifically for that hose.

### HOSE COUPLINGS CAN BE BROADLY DIVIDED INTO TWO TYPES:

#### 1) FIELD ATTACHABLE COUPLINGS

Attached to the hose using commonly available hand tools. Push-On Hose Couplings and Suction and Return Hose Couplings are often classed as Field Attachable couplings.

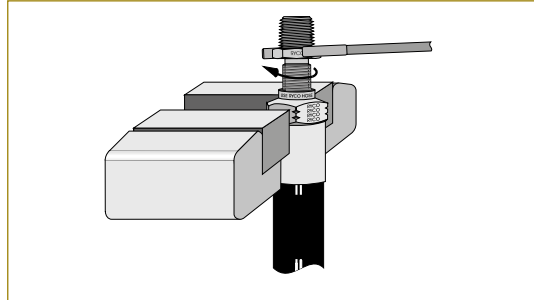

#### 2) CRIMP, OR SWAGE, COUPLINGS

Permanently attached to the hose using a crimping, or swaging, machine.

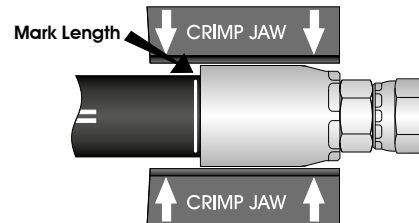

### DO NOT MIX / MATCH HOSE AND COUPLINGS FROM DIFFERENT MANUFACTURERS.

It is critical that the hose and coupling manufacturer are the same and that they are assembled using the manufacturer's recommended equipment, components and procedures.

Female Swivel Nut fittings are typically illustrated as "Crimp Nut", except T7020H.

Generally, Ryco Fittings are as follows:

1. BSPP, NPSM, JIC, JIS, ORFS and SAE nuts are "Crimp Nut" up to and including 1" Hose Size; and "Wire Nut" 1.1/4" to 2" Hose Size.
2. PW and SAE Inverted Flare Male nuts are always "Slip Nut."
3. JSEAL™, Metric DKL, DKOL, DKS and DKOS nuts are generally "Slip Nut" where possible and "Wire/Crimp Nut" on jump sizes.
4. T7022 is "Wire Nut".

**There are many exceptions to these general rules; for precise information, contact Ryco.**

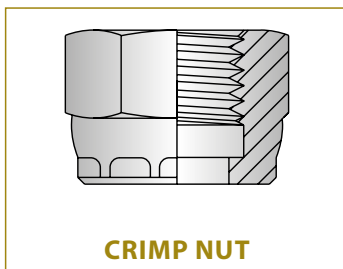

**CRIMP NUT**

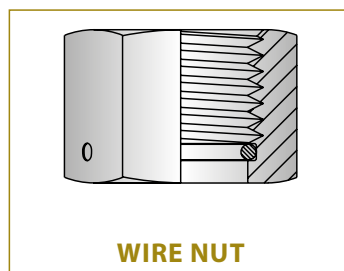

**WIRE NUT**

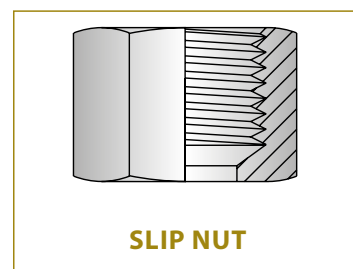

**SLIP NUT**

**ONE-PIECE CRIMP COUPLINGS**

Ryco Crimp Couplings are permanently attached fittings, assembled onto the hose with a swaging press.

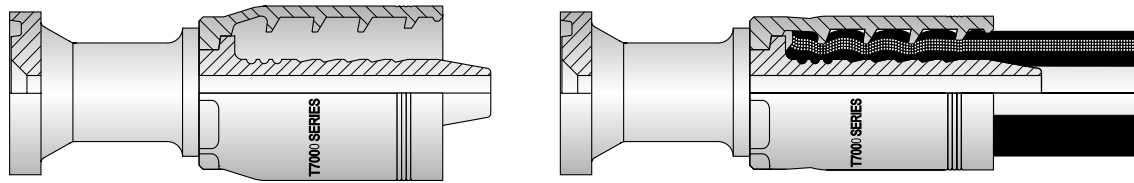

Ryco One-Piece Crimp Couplings have the ferrule already attached to the hose insert at the factory. This eliminates the possibility of selecting the wrong ferrule type when fabricating hose assemblies, which can cause failure of the assembly.

Each One-Piece Crimp Coupling Series suits specific styles of hose, as shown in the table below. T2000, T4000, T6000, T7000, TP000 and TT000 One-Piece Crimp Couplings Series can be used on more than one hose style - only the finished crimp diameter changes.

One-Piece Crimp couplings eliminate the need to "skive" the cover off the hose before attaching the couplings - even for Spiral reinforced hoses. This makes assembly simple, quick and efficient. Simply push the coupling onto the hose to the correct mark length, and crimp the ferrule. The teeth inside the ferrule BITE down though the cover to LOK onto the reinforcement wires\*.

\* T4000 Series for One and Two Braid Textile reinforced hoses do not bite down to the textile reinforcement.

**RYCO T2000, T4000, T6000, T7000 SERIES COUPLINGS**

Branding of T2000, T4000, T6000 and T7000 Couplings shows a universal prefix "R".

T2000 has two grooves, T4000 has three grooves and T6000 has six grooves (three at the top and three at the bottom of the ferrule) branded on the ferrule (body) of the Couplings signifying their series designation, T7000 has four grooves.

**T2000 EXAMPLE**

To complete the Part Number for Coupling:  
Insert Part Branding is **R090-0608**  
Series is **T2000** (from **T2000** Ferrule Branding or Two Series Code Grooves)  
Simply replace "R" of Insert Part Branding with "T2" (first two characters of Series): **T2090-0608**

**T4000 EXAMPLE**

To complete the Part Number for Coupling:  
Insert Part Branding is **R090-0608**  
Series is **T4000** (from **T4000** Ferrule Branding or Three Series Code Grooves)  
Simply replace "R" of Insert Part Branding with "T4" (first two characters of Series): **T4090-0608**

# INTRODUCTION

## INFORMATION

### RYCO T2000, T4000, T6000 AND T7000 SERIES COUPLINGS (CONT)

**T6000 EXAMPLE**

Insert branding **6R013-1212**

Six Series Code Grooves (three on top and three on bottom of ferrule) identify **T6000 Series**

Ferrule branding **T6000 Series**

To complete the Part Number for Coupling: Insert Part Branding is **6R013-1212**

Series is **T6000** (from Six Series Code Groove, three at each end)

Simply replace "R" of Insert Part Branding with "T6" (first two characters of Series): **T6013-1212**

**T7000 EXAMPLE**

Insert branding **R010-1616**

Four Series Code Grooves identify **T7000 Series**

Ferrule branding **T7000 Series**

To complete the Part Number for Coupling: Insert Part Branding is **R010-1616**

Series is **T7000** (from **T7000** Ferrule Branding or Four Series Code Grooves)

Simply replace "R" of Insert Part Branding with "T7" (first two characters of Series): **T7010-1616**

### RYCO TP000, TT000 SERIES COUPLINGS

Branding of TP000 and TT000 Couplings shows a universal prefix "R".

TP000 has two knurls, TT000 has four grooves branded on the ferrule (body) of the Couplings signifying their series designation.

**TP000 EXAMPLE**

Insert branding **TP010-1616**

Two Series Code Knurls (one at each end of ferrule) identify **TP000 Series**

Ferrule branding **TP000 Series**

To complete the Part Number for Coupling: Insert Part Branding is **TP010-1616**

Series is **TP000** (from **TP000** Ferrule Branding or Two Series Code Knurls)

Simply replace "R" of Insert Part Branding with "TP" (first two characters of Series): **TP010-1616**

**TT000 EXAMPLE**

Insert branding **R010-1616**

Two Series Code Grooves identify **TT000 Series**

Ferrule branding **TT000 Series**

To complete the Part Number for Coupling: Insert Part Branding is **R010-1616**

Series is **TT000** (from **TT000** Ferrule Branding or Four Series Code Grooves)

Simply replace "R" of Insert Part Branding with "TT" (first two characters of Series): **TT010-1616**

SERIES	SUITS HOSE TYPE	RYCO HOSE SERIES AND SIZES
<b>T2000</b> Pages 21 to 77	<b>One and two wire braided hoses.</b> <b>TWO SERIES CODE GROOVES</b> (at end of ferrule).	For Ryco Hose Series, T3000D/S, T3600D/S (sizes -04 to -16). For Ryco Hose Series T4000D/S (sizes -04 to -12). For Ryco Hose Series T5000D/S (sizes -04 to -08). For Ryco Hose Series T6000D/S (sizes -04 to -06). For Ryco Hose Series T1D/S (sizes -03 to -32). For Ryco Hose Series SURVIVOR/1 (sizes -04 to -16). For Ryco Hose Series E1 (sizes -03 to -32). For Ryco Hose Series T3 (sizes -04 to -16). For Ryco Hose Series T2D/S (sizes -04 to -48). For Ryco Hose Series TJD (sizes -24 to -26). For Ryco Hose Series T2C (sizes -04 to -32). For Ryco Hose Series E2/C (sizes -03 to -16). For Ryco Hose Series DF2D (sizes -04 to -20). For Ryco Hose Series D2B (sizes -24 to -32). For Ryco Hose Series JS4000/B/G/BX/GX (sizes -04 to -08). For Ryco Hose Series JS6000/B/G/BX/GX (sizes -04 to -08). For Ryco Hose Series TW (sizes -04 to -08). For Ryco Hose Series PW (sizes -04 to -06). For Ryco Hose Series BT1 (sizes -04 to -16). For Ryco Hose Series MS1000 (sizes -08 to -32).
<b>T4000</b> Pages 78 to 99	<b>Some one and two textile braided hoses and some speciality hoses.</b> <b>THREE SERIES CODE GROOVES</b> (at end of ferrule).	For Ryco Hose Series SRF/P, SRX/HT (sizes -12 to -48). For Ryco Hose Series RT7/T/7N/7TN (sizes -02 to -12). For Ryco Hose Series T5, SURVIVOR/R5 (sizes -04 to -32). For Ryco Hose Series MP1 (sizes -04 to -20). For Ryco Hose Series M2/G, PL1D, PL1PV (sizes -04 to -12).
<b>T6000</b> Pages 100 to 130	<b>Selected spiral hoses.</b> <b>TWO SETS OF THREE SERIES CODE GROOVES</b> (one at each end of ferrule).	For Ryco Hose Series H5000 (sizes -24 to -32). For Ryco Hose Series H6000 (sizes -12 to -32).
<b>T7000</b> Pages 131 to 178	<b>Selected spiral hoses and some one and two wire braided hoses.</b> <b>FOUR SERIES CODE GROOVES</b> (at end of ferrule).	For Ryco Hose Series H3000D/S (sizes -20 to -32). For Ryco Hose Series H4000D/S (sizes -06 to -32). For Ryco Hose Series H5000D/S (sizes -06 to -24). For Ryco Hose Series H6000D/S (sizes -06 to -20). For Ryco Hose Series T2D/S/C (sizes -06 to -32). For Ryco Hose Series E2, HSPD (sizes -06 to -16). For Ryco Hose Series H12D/S (sizes -06 to -20). For Ryco Hose Series R4SH, HSHD (sizes -20 to -32). For Ryco Hose Series T2, TXA2D, SURVIVOR/2 (sizes -06 to -32). For Ryco Hose Series D2B (sizes -24 to -32). For Ryco Hose Series R4SP (cover must be skived) (all sizes).
<b>TP000</b> Pages 174 to 190	<b>Thermoplastic hoses.</b> <b>TWO SERIES CODE KNURLS</b> (one at each end of ferrule).	For Ryco Hose Series TP7, TP7N, TP7T, TP7TN, TP8, TP8N, TP8T, TP8TN, TP3000 (all sizes).
<b>TT000</b> Pages 191 to 197	<b>TEFLON® hoses.</b> <b>TWO SERIES CODE GROOVES</b> (one at each end of ferrule).	For Ryco Hose Series RTH1 (all sizes).
<b>TG000</b> Pages 198 to 200	<b>Greasing and lubrication hoses.</b> <b>ONE SERIES CODE KNURL</b> (at end of ferrule).	For Ryco Thermoplastic grease line hoses - TPGL (all sizes).
<b>TW4000</b> Page 201	<b>SHOCKWAVE hoses.</b> <b>FOUR SERIES CODE GROOVES</b> (at end of ferrule).	For Ryco Hose Series SHOCKWAVE (all sizes).

INTRODUCTION

INDEXES

ONE-PIECE COUPLINGS

PUSH-ON SUCTION & RETURN COUPLINGS

FIELD ATTACHABLE COUPLINGS

HYDRAULIC FITTINGS ACCESSORIES

# INDEXES

## MALE STRAIGHT

<b>T2010/11</b> P21	<b>T2013</b> P22	<b>T2017</b> P23	<b>T2220</b> P42	<b>T2320</b> P24	<b>T2475</b> P25	<b>T2090</b> P30	<b>T2091</b> P30	
<b>T4010</b> P78	<b>T4013</b> P78		<b>T4320</b> P79		<b>T4090</b> P81			
<b>T6010</b> P100	<b>T6013</b> P100				<b>T6090</b> P102	<b>T6091</b> P102		
<b>T7010</b> P131	<b>T7014</b> P131	<b>T7013</b> P132				<b>T7090</b> P136	<b>T7091</b> P137	
<b>TP010</b> P174					<b>TP475</b> P176	<b>TP090</b> P177		
<b>TT010</b> P191				<b>TT320</b> 191		<b>TT090</b> P196		
BSPT MALE	BSPT MALE HEAVY	BSPP MALE	BSPP MALE CAPTIVE SEAL	BSPP MALE 60° CONVEX SEAT (JIS)	BSPT MALE SWIVEL	BSP BANJO	NPTF MALE	NPTF MALE EXTENDED

## MALE STRAIGHT cont'd

<b>T2320N</b> P31	<b>T2030/31</b> P33	<b>T2650</b> P45	<b>T2630</b> P51	<b>T2470</b> P55	<b>T2840</b> P56	<b>T2950</b> P62	<b>T2480</b> P64	
<b>T4320N</b> P81	<b>T4030/31</b> P82		<b>T6630</b> P106		<b>T6840</b> P107			
<b>T7030/31</b> P137			<b>T7630</b> P146	<b>T7840</b> P148	<b>T7480</b> P154			
<b>TP030/31</b> P178		<b>T7039</b> P139	<b>TP650</b> P182	<b>TP630</b> P184	<b>TP470</b> 186			
<b>TT030/31</b> P193								
NPTF MALE SWIVEL	JIC MALE	JIC MALE SWIVEL JOINT	METRIC DKL MALE 24° CONE	METRIC DKS MALE 24° CONE	METRIC BANJO	ORFS MALE	PW GUN HANDLE TUBE	RYCO WEO MALE

## MALE STRAIGHT cont'd

<b>T2870</b> P63	<b>T2530</b> P66	<b>T2740</b> P67	<b>T2200</b> P76	<b>T2380</b> P77	<b>T2482</b> P65			<b>T2871</b> P63	
<b>T4870</b> P96	<b>T4530</b> P93	<b>T4740</b> P94	<b>T4200</b> P98						
<b>T6870</b> P110	<b>T6876</b> P110							<b>T6871</b> P109	
<b>T7870</b> P152	<b>T7876</b> P154	<b>T7200</b> P173			<b>T7482</b> P154				<b>T7871</b> P153
RYCOLOK MALE	SUPERLOK MALE	SAE MALE	SAE INVERTED MALE FLARE	UN O RING MALE (O RING BOSS)	UN O RING MALE SWIVEL (O RING BOSS)	RYCO WEO MALE 45° TUBE BEND		RYCOLOK MALE 45° ELBOW	

## MALE 45°

## MALE 45°, 60° & 90°

<b>T2750</b> P68	<b>T2760</b> P69	<b>T2340</b> P24	<b>T2340N</b> P6	<b>T2483</b> P65	<b>T2872</b> P64	<b>T2780</b> P68	<b>T2790</b> P68	<b>T2770</b> P69
<b>T4750</b> P95	<b>T4340</b> P79		<b>T6872</b> P110					
				<b>T7483</b> P155	<b>T7872</b> P153			
<b>TP340N</b> P177								
SAE INVERTED MALE FLARE 45° TUBE BEND	SAE INVERTED MALE FLARE 60° TUBE BEND	BSPT MALE SWIVEL 90° ELBOW	NPTF MALE SWIVEL 90° ELBOW	RYCO WEO MALE 90° TUBE BEND	RYCOLOK MALE 90° ELBOW	SAE INVERTED MALE FLARE 90° ELBOW	SAE INVERTED MALE FLARE 90° EXTENDED ELBOW	SAE INVERTED MALE FLARE 90° TUBE BEND

# PICTORIAL INDEX

INTRODUCTION

INDEXES

ONE-PIECE COUPLINGS

PUSH-ON SUCTION & RETURN COUPLINGS

FIELD ATTACHABLE COUPLINGS

HYDRAULIC FITTINGS ACCESSORIES

FEMALE STRAIGHT

<b>T2390</b> P77	<b>T2020</b> P23	<b>T2028B</b> P24		<b>T2024</b> P25	<b>T2122</b> P42	<b>T2027</b> P7	<b>T2190</b> P32	<b>T2020N</b> P32
<b>T4020</b> P79					<b>T4122</b> P87		<b>T4020N</b> P82	
<b>T6020</b> P101			<b>T6022</b> P101			<b>T6020N</b> 103		
<b>T7020</b> P132			<b>T7022</b> P133		<b>T7122</b> P144	<b>T7027</b> P135	<b>T7020N</b> 137	
<b>TP020</b> P174					<b>TP122</b> P175		<b>TP020N</b> P178	
<b>TT020</b> P192								
UN O RING MALE SWIVEL (O RING BOSS)	BSPP FEMALE	BSPP FEMALE LIVE SWIVEL	BSPP FEMALE HEAVY	BSPP FEMALE FLAT FACE	BSPP FEMALE 60° CONCAVE SEAT (JIS)	BSPO FEMALE	NPT FEMALE FIXED	NPSM FEMALE

FEMALE STRAIGHT cont'd

<b>T2861</b> P33	<b>T2040/41</b> P35		<b>T2600</b> P46	<b>T2610</b> P47	<b>T2501</b> P48	<b>T2711</b> P52	<b>T2680</b> P43	
<b>T4040/41</b> P83			<b>T4600</b> P88		<b>T4501</b> P89			
<b>T6040</b> P104			<b>T6045</b> P104			<b>T6711</b> P106		
<b>T7040/41</b> P138			<b>T7044</b> P138	<b>T7045</b> P139		<b>T7501</b> P145	<b>T7711</b> P146	<b>T7680</b> P144
<b>TP040/41</b> P179			<b>TP600</b> XXX		<b>TP501</b> P183		<b>TP711</b> P185	
<b>TT040/41</b> P194			<b>TT600</b> XXX					
GREASE LINE FIXED FEMALE	JSEAL™ / JIC FEMALE	JIC FEMALE SWIVEL JOINT	JIC FEMALE HIGH PRESSURE	METRIC DKL FEMALE 24°/60° CONE	METRIC DKM FEMALE 60° BALL SEAT	METRIC DKOL FEMALE 24° CONE	METRIC DKOS FEMALE 24° CONE	METRIC FEMALE 60° CONCAVE SEAT (JIS)

FEMALE STRAIGHT cont'd & FEMALE 45°

<b>T2800/01</b> P56	<b>T2540</b> P66	<b>T2940</b> P44	<b>T2060</b> P25	<b>T2080/81</b> P36	<b>T2580</b> P67	<b>T2270</b> P26	<b>T2277</b> P29	<b>T2250/51</b> P38
<b>T4800/01</b> P90		<b>T4540</b> P93		<b>T4250/51</b> P84				
<b>T6800/01</b> P107				<b>T6080</b> XXX		<b>T6270</b> P101		<b>T6250</b> P104
<b>T7800/01</b> P148			<b>T7060</b> P133	<b>T7080</b> P140	<b>T7270</b> P134	<b>T7277</b> P136	<b>T7250/51</b> P140	
<b>TP800/01</b> P188		<b>TP540</b> P190		<b>TP270</b> P176			<b>TP250/51</b> P180	
ORFS FEMALE	SAE FEMALE	PRESSURE WASHER FEMALE	BSPP FEMALE 45° ELBOW	JSEAL™ / JIC FEMALE 45° ELBOW	SAE FEMALE 45° ELBOW	BSPP FEMALE 45° TUBE BEND	BSPO FEMALE 45° TUBE BEND	JSEAL™ / JIC FEMALE 45° TUBE BEND

FEMALE STRAIGHT cont'd & FEMALE 45°

<b>T2682</b> P105	<b>T2682</b> P43
METRIC JIS FEMALE 60° CONCAVE SEAT 45° TUBE BEND	METRIC JIS FEMALE 60° CONCAVE SEAT 45° TUBE BEND

# INDEXES

## PICTORIAL INDEX

FEMALE  
45°  
cont'd  
&  
FEMALE  
90°

<b>T2660</b> P46	<b>T2510</b> P49	<b>T2720</b> P69	<b>T2810/11</b> P58	<b>T2050</b> P26	<b>T2057</b> P28	<b>T2070/71</b> P37	<b>T2570</b> P67
<b>T4660</b> P88	<b>T6720</b> P106		<b>T6810/11</b> P108	<b>T4550</b> P94	<b>T4050</b> P80	<b>T4570</b> P93	
<b>T7510</b> P145		<b>T7720</b> P147	<b>T7810/11</b> P149	<b>T7050</b> P133	<b>T7057</b> P135	<b>T7070</b> P140	
<b>TP510</b> P183		<b>TP720</b> P185	<b>TP810/11</b> P189	<b>TP050</b> P175		<b>TP570</b> P190	
<b>TT050</b> P192							
METRIC DKL FEMALE 24°/60° CONE 45° TUBE BEND	METRIC DKOL FEMALE 24° CONE 45° TUBE BEND	METRIC DKOS FEMALE 24° CONE 45° TUBE BEND	ORFS FEMALE 45° TUBE BEND	SAE FEMALE 45° TUBE BEND	BSPP FEMALE 90° ELBOW	BSPO FEMALE 90° ELBOW	JSEAL™ / JIC FEMALE 90° ELBOW

FEMALE  
90°  
cont'd

<b>T2260</b> P27	<b>T2210</b> P27	<b>T2267</b> P29	<b>T2243/44</b> P39	<b>T2240/41</b> P40	<b>T2280/81</b> P41	<b>T2683</b> P44	<b>T2670</b> P47
<b>T4260</b> P80	<b>T4243</b> P85		<b>T4240/41</b> P86	<b>T4280/81</b> P87	<b>T4670</b> P88		
<b>T6260</b> P102	<b>T6240</b> P105			<b>T6280</b> P105			
<b>T7260</b> P134	<b>T7210</b> P135	<b>T7267</b> P136	<b>T7243</b> P141	<b>T7240/41</b> P142	<b>T7245</b> P143	<b>T7280</b> P143	
<b>TP260</b> P175			<b>TP240/41</b> P181		<b>TP280</b> P182		
<b>TT260</b> P192			<b>TT240/41</b> P195			<b>TT670</b> P196	
BSPP FEMALE 90° TUBE BEND	BSPP FEMALE 90° LONG BEND	BSPO FEMALE 90° TUBE BEND	JSEAL™ / JIC FEMALE 90° SHORT BEND	JSEAL™ / JIC FEMALE 90° MEDIUM BEND	JIC FEMALE HIGH PRESSURE 90° MEDIUM BEND	JSEAL™ / JIC FEMALE 90° LONG BEND	METRIC FEMALE 90° CONCAVE SEAT (JIS) 90° TUBE BEND

FEMALE  
90°  
cont'd

<b>T2520</b> P50	<b>T2730</b> P54	<b>T2823/24</b> P59	<b>T2820/21</b> P60	<b>T2830</b> P61	<b>T2900</b> P44		
<b>T4820/21</b> P92			<b>T4830</b> P92	<b>T4560</b> P94	<b>T6900</b> P105		
<b>T6730</b> P107		<b>T6820/21</b> P109				<b>T7900</b> P145	
<b>T7520</b> P146	<b>T7730</b> P147	<b>T7823/24</b> P150	<b>T7820/21</b> P151	<b>T7830</b> P152	<b>JOINER</b>		
<b>TP520</b> P184		<b>TP730</b> P186	<b>TP820/21</b> P189			<b>JOINER</b>	
						<b>JOINER</b>	
METRIC DKOL FEMALE 24° CONE 90° TUBE BEND	METRIC DKOS FEMALE 24° CONE 90° TUBE BEND	ORFS FEMALE 90° SHORT BEND	ORFS FEMALE 90° MEDIUM BEND	ORFS FEMALE 90° LONG BEND	SAE FEMALE 90° TUBE BEND	JOINER	

SALVAGE  
STANDPIPE

<b>T2230</b> P72	<b>T2180</b> P73	<b>T2640</b> P74	<b>T2646</b> P75		<b>T2850</b> P76
<b>T4230</b> P98					<b>T4850</b> P99
<b>T7230</b> P172	<b>T7640</b> P172		<b>T7643</b> XXX		
<b>TP640</b> P187		<b>TP643</b> P187	<b>TP646</b> P187		
					<b>TUBE BITE</b>
SALVAGE (LIFESAVER)	IMPERIAL STANDPIPE	METRIC STANDPIPE	METRIC STANDPIPE 45° TUBE BEND	METRIC STANDPIPE 90° TUBE BEND	TUBE BITE

**SAE FLANGE CODE 61**

<b>T2130</b> P70		<b>T2150</b> P71			<b>T2170</b> P72	
<b>T4130</b> P96		<b>T4150</b> P97			<b>T4170</b> P97	
<b>T6130</b> P111	<b>T6290</b> P112	<b>T6150</b> P112	<b>T6300</b> P113	<b>T6160</b> XXX	<b>T6170</b> P113	
<b>T7130</b> P156	<b>T7140</b> P157	<b>T7290</b> P158	<b>T7150</b> P157	<b>T7300</b> P158	<b>T7160</b> P159	<b>T7170</b> P159
CODE 61 FLANGE	CODE 61 FLANGE 22.5° TUBE BEND	CODE 61 FLANGE 30° TUBE BEND	CODE 61 FLANGE 45° TUBE BEND	CODE 61 FLANGE 60° TUBE BEND	CODE 61 FLANGE 67.5° TUBE BEND	CODE 61 FLANGE 90° TUBE BEND

**SAE FLANGE CODE 61 cont'd**

<b>T4173</b> P250				
<b>T7171</b> P160	<b>T7172</b> P160	<b>T7173</b> P160	<b>T7174</b> P161	<b>T7910</b> P161
CODE 61 FLANGE 90° SPECIAL TUBE BEND	CODE 61 FLANGE 90° SPECIAL TUBE BEND	CODE 61 FLANGE 90° LONG TUBE BEND	CODE 61 FLANGE 90° SPECIAL TUBE BEND	CODE 61 FLANGE 110° TUBE BEND

**SAE FLANGE CODE 62**

<b>T6330</b> P114	<b>T6334</b> P115	<b>T6440</b> P116	<b>T6450</b> P118	<b>T6350</b> P120	<b>T6460</b> P125	<b>T6360</b> P122	<b>T6370</b> P127	<b>T6930</b> P129
<b>T7330</b> P162	<b>T7334</b> P9	<b>T7440</b> P162	<b>T7450</b> P163	<b>T7350</b> P163	<b>T7460</b> P164	<b>T7360</b> P164	<b>T7370</b> P165	<b>T7930</b> P165
CODE 62 FLANGE	CODE 62 D-RING FLANGE	CODE 62 FLANGE 22.5° TUBE BEND	CODE 62 FLANGE 30° TUBE BEND	CODE 62 FLANGE 45° TUBE BEND	CODE 62 FLANGE 60° TUBE BEND	CODE 62 FLANGE 67.5° TUBE BEND	CODE 62 FLANGE 90° TUBE BEND	CODE 62 FLANGE 110° TUBE BEND

**SPECIAL FLANGE RYCO CODE 62C**

<b>T6333</b> P114	<b>T6443</b> P117	<b>T6444</b> P117	<b>T6453</b> P118	<b>T6454</b> P119	<b>T6353</b> P120	<b>T6354</b> P121	<b>T6463</b> P126	<b>T6464</b> P126
<b>T7333</b> P166	<b>T7443</b> P166	<b>T7444</b> 166	<b>P167</b> P300	<b>T7454</b> P167	<b>T7353</b> 168	<b>T7354</b> P168	<b>T7463</b> P169	<b>T7464</b> P169
RYCO CODE 62C FLANGE	RYCO CODE 62C FLANGE 22.5° TUBE BEND	RYCO CODE 62C D-RING FLANGE 22.5° TUBE BEND	RYCO CODE 62C FLANGE 30° TUBE BEND	RYCO CODE 62C D-RING FLANGE 30° TUBE BEND	RYCO CODE 62C FLANGE 45° TUBE BEND	RYCO CODE 62C D-RING FLANGE 45° TUBE BEND	RYCO CODE 62C FLANGE 60° TUBE BEND	RYCO CODE 62C D-RING FLANGE 60° TUBE BEND

**SPECIAL FLANGE RYCO CODE 62C cont'd**

<b>T6363</b> P124	<b>T6364</b> P124	<b>T6373</b> P128	<b>T6374</b> P125	<b>T6933</b> P129	<b>T6335</b> P115	<b>T6912</b> P116	<b>T6445</b> P116	
<b>T7363</b> P170	<b>T7364</b> P170	<b>T7378</b> P171	<b>T7373</b> P171	<b>T7374</b> P171	<b>T7933</b> 172			
RYCO CODE 62C FLANGE 67.5° TUBE BEND	RYCO CODE 62C D-RING FLANGE 67.5° BEND	RYCO CODE 62C D-RING FLANGE 90° BEND	RYCO CODE 62C FLANGE 90° TUBE BEND	RYCO CODE 62C D-RING FLANGE 110° TUBE BEND	RYCO CODE 62C FLANGE 110° TUBE BEND	RYCO CODE 62K FLANGE	RYCO CODE 62C FLANGE 15° TUBE BEND	RYCO CODE 62K FLANGE 22.5° TUBE BEND

**SPECIAL FLANGE RYCO CODE 62K**

<b>T6455</b> P119	<b>T6355</b> P121	<b>T6359</b> P122	<b>T6465</b> P122	<b>T6914</b> P123	<b>T6916</b> P123	<b>T6918</b> P123	<b>T6375</b> P127	<b>T6936</b> P128
RYCO CODE 62K FLANGE 30° TUBE BEND	RYCO CODE 62K FLANGE 45° TUBE BEND	RYCO CODE 62K D-RING FLANGE 45° TUBE BEND	RYCO CODE 62K FLANGE 60° TUBE BEND	RYCO CODE 62K FLANGE 70° TUBE BEND	RYCO CODE 62K FLANGE 75° TUBE BEND	RYCO CODE 62K FLANGE 80° TUBE BEND	RYCO CODE 62K FLANGE 90° TUBE BEND	RYCO CODE 62K FLANGE 100° TUBE BEND

INTRODUCTION

INDEXES

ONE-PIECE COUPLINGS





PUSH-ON SUCTION & RETURN COUPLINGS

FIELD ATTACHABLE COUPLINGS



HYDRAULIC FITTINGS ACCESSORIES

## PICTORIAL INDEX

**SPECIAL  
FLANGE  
RYCO  
CODE 62K**

T6932 P128	T6914 P123	T6916 P123	T6918 P123	T6375 P127
				
RYCO CODE 62K FLANGE 110° TUBE BEND	RYCO CODE 62K FLANGE 70° TUBE BEND	RYCO CODE 62K FLANGE 75° TUBE BEND	RYCO CODE 62K FLANGE 80° TUBE BEND	RYCO CODE 62K FLANGE 90° TUBE BEND

**HAMMER  
UNION**

T61502 P129	T61501 P130
T71502 P304	T71501 P304
	
FIG 1502 MALE (WITH NUT)	FIG 1502 FEMALE (WITH SEAL)

**TW4000 ONE-PIECE CRIMP INTERLOK WATERBLAST COUPLINGS. INTERNAL/EXTERNAL SKIVE**

TW4090 P201	TW4027 P201	TW4711 P201
NPTF MALE 60° SEAT	BSPP FEMALE O RING 60° SEAT	DKOS FEMALE METRIC O RING (HEAVY) 24° CONE

**TG000 ONE-PIECE CRIMP COUPLINGS FOR TPGL SERIES HOSE (GREASELINE)**

TG010 P198	TG320 P198	TG090 P199	TG320N P199	TG030 P200	TG020 P198	TG020N P199	TG040 P200
BSPT MALE	BSPT MALE SWIVEL	NPTF MALE	NPT MALE SWIVEL	JIC MALE	BSPP FEMALE	NPSM FEMALE	JIC FEMALE

**8000 PUSH-ON COUPLINGS FOR PL1D, PL1PV.**

PL1D, PL1PV Hose simply pushes on to 8000 Series couplings. Clamps are required for critical applications, and when Working Pressure exceeds 50% of the Maximum Static Working Pressure. Do not overtighten Clamps as this will damage hose.

8010/S P203	8111 P202	8090 P204	8030 P204	8530 P206	8740 P207	8200 P208	8020 P202	8040 P205	8540 P207
BSPT MALE	BSPP O RING MALE	NPTF MALE	JIC / SAE MALE	JIC / SAE MALE	SAE INVERTED FLARE MALE	UN O RING MALE (O RING BOSS)	BSPP FEMALE	JIC / SAE FEMALE	JIC / SAE FEMALE

8060 P202	8050 P203	8070 P205	8570 P207	8240 P206	8900 P206	8230 P208	8180 P208	8640 P209	8100 P209
BSPP FEMALE 45° ELBOW	BSPP FEMALE 90° ELBOW	JIC / SAE FEMALE 90° ELBOW	JIC / SAE FEMALE 90° ELBOW	JIC FEMALE 90° TUBE BEND	JOINER	SALVAGE (LIFE SAVER)	IMPERIAL STANDPIPE	METRIC STANDPIPE	200 AIR COUPLING NIPPLE

INTRODUCTION

INDEXES

ONE-PIECE COUPLINGS









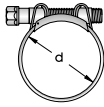

PUSH-ON SUCTION & RETURN COUPLINGS

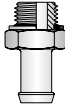
FIELD ATTACHABLE COUPLINGS

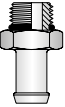
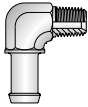
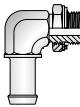
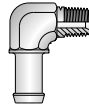
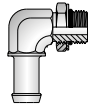
HYDRAULIC FITTINGS ACCESSORIES

## PICTORIAL INDEX

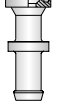
### 33000 SUCTION AND RETURN COUPLINGS FOR SRX/HT AND SRF/P SERIES HOSE

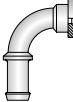
<b>RSC</b> 210	<b>33010</b> P212	<b>33111</b> P210	<b>33090</b> P213	<b>33200</b> P217	<b>33400</b> P213	<b>33410</b> P211	<b>33400N</b> P214	<b>33420</b> P217	<b>33020</b> P211
									
SUCTION HOSE CLAMP	BSPT MALE	BSPP O RING MALE	NPTF MALE	UN O RING MALE (O RING BOSS)	BSPT MALE 90° ELBOW	BSPP O RING MALE 90° ELBOW	NPTF MALE 90° ELBOW	UN O RING MALE (O RING BOSS) 90° ELBOW	BSPP FEMALE
<b>33024</b> P212	<b>33040</b> P214	<b>33130</b> P215	<b>33150</b> P216	<b>33170</b> P216					
									
BSPP FEMALE FLAT FACE	JIC FEMALE	CODE 61 FLANGE	CODE 61 FLANGE 45° TUBE BEND	CODE 61 FLANGE 90° TUBE BEND					

**FIELD ATTACHABLE FERRULES FOR 6000 SERIES INSERTS**

The Ryco Field Attachable system consists of five ferrule styles, each specific to a hose type, and one common Insert. Field Attachable Inserts and Ferrules can be ordered individually, or as a complete coupling for specific hose types.

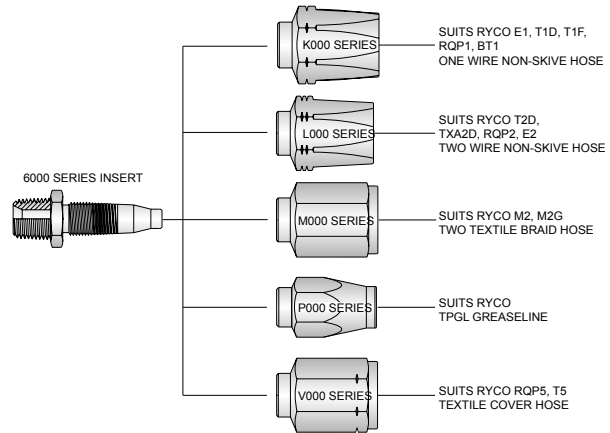

**FIELD ATTACHABLE FERRULES FOR 6000 SERIES INSERTS**

<b>K000</b> P238	<b>L000</b> P238	<b>M000</b> P238	<b>P000</b> P238	<b>V000</b> P241
SUITS RYCO E1, T1D, T1F, SURVIVOR/1, BT1 ONE WIRE NON-SKIVE HOSE	SUITS RYCO E2, T2D, TXA2D, SURVIVOR/2 TWO WIRE NON-SKIVE HOSE	SUITS RYCO M2, M2G TWO TEXTILE BRAID HOSE	SUITS RYCO TPGL GREASELINE	SUITS RYCO SURVIVOR/R5, T5 TEXTILE COVER

**6000 SERIES FIELD ATTACHABLE INSERTS**

6000 Series Inserts for K000, L000, V000, M000 and P000 ferrules.

<b>6010</b> P242	<b>6320</b> P244	<b>6090</b> P248	<b>6091</b> P248	<b>6320N</b> P249	<b>6860</b> P252	<b>6030</b> P250	<b>6650</b> P257	<b>6630</b> P259	<b>6530</b> P263
BSPT MALE	BSPT MALE SWIVEL	NPTF MALE	NPTF MALE EXTENDED	NPTF MALE SWIVEL	GREASE LINE MALE	JIC MALE	METRIC DKL MALE 24° CONE	METRIC DKS MALE 24° CONE	SAE MALE
<b>6740</b> P265	<b>6200</b> P272	<b>6380</b> P272	<b>6750</b> P266	<b>6760</b> P267	<b>6340</b> P244	<b>6780</b> P266	<b>6790</b> P266	<b>6390</b> P273	<b>6770</b> P267
SAE INVERTED MALE FLARE	UN O RING MALE (O RING BOSS)	UN O RING MALE SWIVEL (O RING BOSS)	SAE INVERTED MALE FLARE 45° TUBE BEND	SAE INVERTED MALE FLARE 60° TUBE BEND	BSPT MALE SWIVEL 90° ELBOW	SAE INVERTED MALE FLARE 90° ELBOW	SAE INVERTED MALE FLARE 90° EXTENDED ELBOW	UN O RING MALE SWIVEL (O RING BOSS) 90° ELBOW	SAE INVERTED MALE FLARE 90° TUBE BEND
<b>6020</b> P243	<b>6024</b> P244	<b>6960B</b> P249	<b>6861</b> P252	<b>6040</b> P251	<b>6600</b> P257	<b>6711</b> P259	<b>6680</b> P256	<b>6800</b> P261	<b>6540</b> P263
BSPP FEMALE	BSPP FEMALE FLAT FACE	NPSM FEMALE LIVE SWIVEL	GREASE LINE FIXED FEMALE	JIC FEMALE	METRIC DKL FEMALE 24°/60° CONE	METRIC DKOS FEMALE 24° CONE	METRIC FEMALE 60° CONCAVE SEAT (JIS)	ORFS FEMALE	SAE FEMALE

INTRODUCTION

INDEXES

ONE-PIECE COUPLINGS

PUSH-ON SUCTION & RETURN COUPLINGS















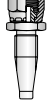



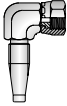

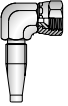







FIELD ATTACHABLE COUPLINGS

HYDRAULIC FITTINGS ACCESSORIES

## PICTORIAL INDEX

### 6000 SERIES FIELD ATTACHABLE INSERTS (CONTINUED)

6000 Series Inserts for K000, L000, V000, M000 and P000 ferrules.

<b>6060</b> P245	<b>6080</b> P253	<b>6580</b> P264	<b>6270</b> P246	<b>6250</b> P254	<b>6660</b> P258	<b>6720</b> P260	<b>6810</b> P261	<b>6550</b> P264	<b>6050</b> P246
									
BSPP FEMALE 45° ELBOW	JIC FEMALE 45° ELBOW	SAE FEMALE 45° ELBOW	BSPP FEMALE 45° TUBE BEND	JIC FEMALE 45° TUBE BEND	METRIC DKL FEMALE 24°/60° CONE 45° TUBE BEND	METRIC DKOS FEMALE 24° CONE 45° TUBE BEND	ORFS FEMALE 45° TUBE BEND	SAE FEMALE 45° TUBE BEND	BSPP FEMALE 90° ELBOW
<b>6052</b> P245	<b>6070</b> P253	<b>6570</b> P264	<b>6260</b> P247	<b>6210</b> P247	<b>6240</b> P255	<b>6280</b> P256	<b>6670</b> P258	<b>6730</b> P260	<b>6820</b> P262
									
BSPP FEMALE FLAT FACE 90° ELBOW	JIC FEMALE 90° ELBOW	SAE FEMALE 90° ELBOW	BSPP FEMALE 90° TUBE BEND	BSPP FEMALE 90° LONG BEND	JIC FEMALE 90° TUBE BEND	JIC FEMALE 90° LONG BEND	METRIC DKL FEMALE 24°/60° CONE 90° TUBE BEND	METRIC DKOS FEMALE 24° CONE 90° TUBE BEND	ORFS FEMALE 90° TUBE BEND
<b>6830</b> P262	<b>6560</b> P265	<b>6563</b> P263	<b>6290</b> XXX	<b>6150</b> XXX	<b>6170</b> P269	<b>6230</b> P270	<b>6180</b> P270	<b>6640</b> P271	<b>6850</b> P271
									
ORFS FEMALE 90° LONG BEND	SAE FEMALE 90° TUBE BEND	SAE FEMALE 90° LONG BEND	CODE 61 FLANGE	CODE 61 FLANGE 45° TUBE BEND	CODE 61 FLANGE 90° TUBE BEND	SALVAGE (LIFESAVER)	IMPERIAL STANDPIPE	METRIC STANDPIPE	TUBE BITE

## INDEX BY END STYLE NUMBER

“Index by End Style Number” is a quick reference if the End Style Number is already known. It can also be used to show the availability of End Styles in different Coupling Series.

**Example:**

End Style of “013” BSPP Male is available in four Series:

**T2000** Series - **T2013** (page 22)

**T4000** Series - **T4013** (page 78)

**T6000** Series - **T6013** (page 100)

**T7000** Series - **T7013** (page 132)

END STYLE NUMBER	END STYLE DESCRIPTION	COUPLING SERIES & PAGE NUMBER										
		T2000	T4000	T6000	T7000	TP000	TT000	TG000	8000	33000	V000	6000
010	BSPT Male	21	23785	100	131	174	191	198	203	212	220	242
013	BSPP Male	22	78	100	132							
014	BSPT Male Heavy				131							
017	BSPP Male Encapsulated Seal	23										
020	BSPP Female	23	79	101	132	174	192	198	202	211	221	243
020N	NPSM Female	32	82	103	137	178		199				
022	BSPP Female Heavy			101	133							
024	BSPP Female Flat Face	25							212			244
027	BSPP Female O Ring	28			135							
028B	BSPP Female Live Swivel	24										
030	JIC Male	33	82	103	137	178	193	200	204		225	250
031	JIC Male - Metric Af	34	82	103	138	178	193					
039	JIC Male Swivel Joint				139							
040	JSEAL™ / JIC Female	35	83	104	138	179	194	200	205	214	225	251
041	JSEAL™ / JIC Female - Metric Af	36	84		139	179	194					
044	JIC Female Swivel Joint				143							
045	JIC Female High-Pressure			104	139							
050	BSPP Female 90° Elbow	26	85		133	175	192		203			246
051	BSPP Female 90° Elbow - Metric Af											
052	BSPP Female Flat Face 90° Elbow - Metric Af											245
057	BSPP O Ring Female 90° Elbow - Metric Af	28			135							
060	BSPP Female 45° Elbow	30			133				202			245
070	JSEAL™ / JIC Female 90° Elbow	37			140				205		226	253
071	JSEAL™ / JIC Female 90° Elbow - Metric Af	38										
080	JSEAL™ / JIC Female 45° Elbow	36			140							253
081	JSEAL™ / JIC Female 45° Elbow - Metric Af	37										367
090	NPTF Male	30	81	102	136	177	196	199	204	213	223	248
091	NPTF Male Extended	30		102	137							248
095	NPT Male - Metric Af											
100	Specials								209			
111	BSPP O Ring Male								202	210		
122	BSPP Female 60° Concave Seat (JIS) - Metric Af	42	87		144	175						
130	SAE Code 61 Flange	70	96	111	156					215		111
135	SAE Code 61 High Pressure Flange											
140	SAE Code 61 Flange 22.5° Tube Bend				157							
150	SAE Code 61 Flange 45° Tube Bend	71	97	112	157					216		268

INTRODUCTION

INDEXES

ONE-PIECE COUPLINGS

PUSH-ON SUCTION & RETURN COUPLINGS

FIELD ATTACHABLE COUPLINGS

HYDRAULIC FITTINGS ACCESSORIES

# INDEXES

## INDEX BY END STYLE NUMBER

END STYLE NUMBER	END STYLE DESCRIPTION	COUPLING SERIES & PAGE NUMBER										
		T2000	T4000	T6000	T7000	TP000	TT000	TG000	8000	33000	V000	6000
160	SAE Code 61 Flange 67.5° Tube Bend				159							
170	SAE Code 61 Flange 90° Tube Bend	72	97	113	159					216		269
171	SAE Code 61 Flange 90° Special Tube Bend				160							
172	SAE Code 61 Flange 90° Special Tube Bend				160							
173	SAE Code 61 Flange 90° Long Tube Bend				160							
174	SAE Code 61 Flange 90° Special Tube Bend				161							
180	Imperial Standpipe	73							208			385
190	NPT Female Fixed	32										
200	UN O Ring Male (O Ring Boss)	76	98		173				208	217	237	272
202	UN O Ring Male (O Ring Boss) - Heavy											
210	BSPP Female 90° Long Tube Bend - Metric AF	27			135							247
220	BSPP Male 60° Convex Seat (JIS) - Metric AF	42										
230	Salvage / Lifesaver	72	98		172				208		236	270
240	JSEAL™ / JIC Female 90° Medium Tube Bend	40	86	105	142	181	195		206		<PB>	255
241	JSEAL™ / JIC Female 90° Medium Tube Bend - Metric AF	40	86		142	181	195					
243	JSEAL™ / JIC Female 90° Short Tube Bend	39	85		141							
244	JSEAL™ / JIC Female 90° Short Tube Bend - Metric AF	39			141							
245	JSEAL™ / JIC Female High-Pressure 90° Tube Bend				143							
250	JSEAL™ / JIC Female 45° Tube Bend	38	84	104	140	180	194				227	254
251	JSEAL™ / JIC Female 45° Tube Bend - Metric AF		85		141	180.						
255	JSEAL™ / JIC Female High-Pressure 45° Tube Bend											
260	BSPP Female 90° Tube Bend	27	80	102	134	175	192				222	247
267	BSPP O Ring Female 90° Tube Bend - Metric AF	29			136							
270	BSPP Female 45° Tube Bend	26		101	134	176					222	246
271	BSPP Female 45° Tube Bend - Metric AF											
277	BSPP O Ring Female 45° Tube Bend - Metric AF	29			136							
280	JSEAL™ / JIC Female 90° Long Tube Bend	41	87	105	143	182					229	105
281	JSEAL™ / JIC Female 90° Long Tube Bend - Metric AF	41	87			182						
290	SAE Code 61 Flange 30° Tube Bend				112	158						
300	SAE Code 61 Flange 60° Tube Bend				113	158						
311	BSPP Female 60° Concave (JIS) 90° Tube Bend											
320	BSPT Male Swivel	24	79				191	198				244
320N	NPTF Male Swivel	31	81					199				249
330	SAE Code 62 Flange			114	162							
333	Ryco Code 62C Flange			114	166							
334	Ryco Code 62C D-Ring Flange			115								
335	Ryco Code 62K Flange			115								
340	BSPT Male Swivel 90° Elbow	24	79									244
340N	NPTF Male Swivel 90° Elbow	31				177						
350	SAE Code 62 Flange 45° Tube Bend			120	163							
353	Ryco Code 62C Flange 45° Tube Bend			120	168							
354	Ryco Code 62C D-Ring Flange 45° Tube Bend			121	168							
355	Ryco Code 62K Flange 45° Tube Bend			121								
359	Ryco Code 62K Flange 45° Long Tube Bend			122								
360	SAE Code 62 Flange 67.5° Tube Bend			122	164							
363	Ryco Code 62C Flange 67.5° Tube Bend			124	170							

## INDEX BY END STYLE NUMBER

END STYLE NUMBER	END STYLE DESCRIPTION	COUPLING SERIES & PAGE NUMBER										
		T2000	T4000	T6000	T7000	TP000	TT000	TG000	8000	33000	V000	6000
364	Ryco Code 62C D-Ring Flange 67.5° Tube Bend			124	170							
370	Ryco Code 62 Flange 90° Bend			127	165							
373	Ryco Code 62C Flange 90° Bend			128	171							
374	Ryco Code 62C D-Ring Flange 90° Tube Bend			125	171							
375	Ryco Code 62K Flange 90° Bend			127								
378	Ryco Code 62C D-Ring Flange 90° Long Tube Bend				171							
380	UN O Ring Male Swivel	77										272
390	UN O RING Male Swivel 90° Elbow	77										
400	BSPT Male 90° Elbow									213		
400N	NPTF Male 90° Elbow									214		
410	BSPP O Ring Male 90° Elbow									211		
420	UN O Ring Male 90° Elbow									217		
440	SAE Code 62 Flange 22.5° Tube Bend			116	162							
443	Ryco Code 62C Flange 22.5° Tube Bend			117	166							
444	Ryco Code 62C D-Ring Flange 22.5° Tube Bend			117								
445	Ryco Code 62K Flange 22.5° Tube Bend			116								
450	SAE Code 62 Flange 30° Tube Bend			118	163							
453	Ryco Code 62C Flange 30° Tube Bend			118	167							
454	Ryco Code 62C D-Ring Flange 30° Tube Bend			119								
455	Ryco Code 62K Flange 30° Tube Bend			119								
460	SAE Code 62 Flange 60° Tube Bend			125	164							
463	Ryco Code 62C Flange 60° Tube Bend			126	169							
464	Ryco Code 62C D-Ring Flange 60° Tube Bend			126	169							
465	Ryco Code 62K Flange 60° Tube Bend			122								
470	Metric Banjo Straight	55				186						
475	BSP Banjo Straight	25				176						
480	Ryco WEO Male	64			154							
482	Ryco WEO Male 45° Tube Bend	65			154							
483	Ryco WEO Male 90° Tube Bend	65			155							
485	Ryco WEO Male O-Ring											
487	Ryco WEO Male O-Ring 90° Tube Bend											
501	DKOL Female	48			145	183						
510	DKOL Female 45° Tube Bend	49				183						
520	DKOL Female 90° Tube Bend	50				184						
530	SAE Male	66	93					206		233	263	
540	SAE Female	66	93			190	197	207		233	263	
550	SAE Female 45° Tube Bend		94							234	264	
560	SAE Female 90° Tube Bend		94								265	
563	SAE Female 90° Long Tube Bend										265	
570	SAE Female 90° Elbow	67	93			190		207			264	
580	SAE Female 45° Elbow	67									264	
600	DKL Female 24°/ 60° Cone	46	88				196				257	
610	DKM Female 60° Ball Seat	47									XXX	
630	DKS Male	51	XXX	106	146	184					259	
640	Metric Standpipe	74			172	187		209			271	
643	Metric Standpipe 45° Tube Bend					187						

INTRODUCTION

INDEXES

ONE-PIECE COUPLINGS

PUSH-ON SUCTION & RETURN COUPLINGS

FIELD ATTACHABLE COUPLINGS

HYDRAULIC FITTINGS ACCESSORIES

# INDEXES

## INDEX BY END STYLE NUMBER

END STYLE NUMBER	END STYLE DESCRIPTION	COUPLING SERIES & PAGE NUMBER										
		T2000	T4000	T6000	T7000	TP000	TT000	TG000	8000	33000	V000	6000
646	Metric Standpipe 90° Tube Bend					187						
650	DKL Male 24° Cone	45				182						257
660	DKL Female 45° Tube Bend	46	88									258
670	DKL Female 90° Tube Bend	47	88					196				258
680	Metric Female 60° Concave Seat (JIS)	43			144							256
682	Metric Female 60° Concave Seat (JIS) 45° Tube Bend	43										XXX
683	Metric Female 60° Concave Seat (JIS) 90° Tube Bend	44										XXX
711	DKOS Female 24° Cone	52		106	146	185						259
720	DKOS Female 24° Cone 45° Tube Bend	53		106	147	185						260
730	DKOS Female 24° Cone 90° Tube Bend	54		107	147	186						260
733	DKOS Female 90° Long Tube Bend											
740	SAE Inverted Male Flare	67	94								234	265
750	SAE Inverted Male Flare 45° Tube Bend	68	95								235	266
760	SAE Inverted Flare Male 60° Tube Bend	69										267
770	SAE Inverted Flare Male 90° Tube Bend	69	95									267
780	SAE Inverted Flare Male 90° Elbow	68										266
790	SAE Inverted Flare Male 90° Long Elbow	68										266
800	ORFS Female	56	90	107	148	188					230	261
801	ORFS Female - Metric AF	57	90	108	149	188						
810	ORFS Female 45° Tube Bend	58	91	91	149						231	261
811	ORFS Female 45° Tube Bend - Metric AF	58	91	108	150	189						
813	ORFS Female 45° Short Tube Bend											
820	ORFS Female 90° Medium Tube Bend	60	92	109	151	189					231	262
821	ORFS Female 90° Medium Tube Bend - Metric AF	61	92	109	151	190						
823	ORFS Female 90° Short Tube Bend	59			150							
824	ORFS Female 90° Short Tube Bend - Metric AF	59			150							
830	ORFS Female 90° Long Tube Bend	61	92		152						232	262
831	ORFS Female 90° Long Tube Bend - Metric AF	62			152							
840	ORFS Male	148	89	107	148							
841	ORFS Male - Metric AF											
850	Tube Bite	76	99									
860	Grease Line Male (UNS)											252
861	Grease Line Fixed Female (UNS)	33										252
864	RYCOLOK Male Hammer Ring											
865	RYCOLOK Male Easy Out											
866	SUPERLOK Male Hammer Ring											
867	SUPERLOK Male Easy Out											
870	RYCOLOK Male	63	96	110	152							
871	RYCOLOK Male 45° Elbow	63			153							
872	RYCOLOK Male 90° Elbow	64			153							
874	RYCOLOK Fixed Female											
876	SUPERLOK Male			110	154							
900	Joiner	44		105	145				206			
901	Joiner 90° Tube Bend											
910	SAE Code 61 Flange 110° Tube Bend				161							

## INDEX BY END STYLE NUMBER

END STYLE NUMBER	END STYLE DESCRIPTION	COUPLING SERIES & PAGE NUMBER										
		T2000	T4000	T6000	T7000	TP000	TT000	TG000	8000	33000	V000	6000
<b>912</b>	Ryco Code 62K Flange 15° Tube Bend			116								
<b>914</b>	Ryco Code 62K Flange			123								
<b>916</b>	Ryco Code 62K Flange 75° Tube Bend			123								
<b>918</b>	Ryco Code 62K Flange 80° Tube Bend			123								
<b>930</b>	SAE Code 62 Flange 110° Tube Bend			129	165							
<b>932</b>	Ryco Code 62k Flange 100° Bend			128								
<b>933</b>	Ryco Code 62C Flange 110° Tube Bend			129								
<b>936</b>	Ryco Code 62K Flange 100° Tube Bend			128								
<b>940</b>	Pressure Washer Female	62										
<b>950</b>	Pressure Washer Gun Handle Tube	62										
<b>960B</b>	NPSM Female Live Swivel											249
<b>1501</b>	Figure 1502 Hammer Union Female (male thread)			130	173							
<b>1502</b>	Figure 1502 Hammer Union Male (with nut)			129	173							
<b>1502A</b>	Figure 1502 Hammer Union Male (reduced head dia.)											

INTRODUCTION

INDEXES

ONE-PIECE COUPLINGS

PUSH-ON SUCTION & RETURN COUPLINGS

FIELD ATTACHABLE COUPLINGS

HYDRAULIC FITTINGS ACCESSORIES

## WORKING PRESSURE OF HOSE ASSEMBLIES

Working Pressure of each Hose Coupling End Style Termination is shown in the Technical section. In most cases, the Working Pressure of the Hose Coupling End Style Termination that can be chosen for a particular hose exceeds the Maximum Working Pressure of the Hose. It is possible however, to select a Hose Coupling with an End Style having a lower Working Pressure than the Hose. In this case, as noted in SAE J516 and SAE J517, the rated Working Pressure of the Hose Assembly must not exceed the lower of the respective Working Pressure rated values.

### EXAMPLE 1.

**T28D** Hose Assembly with **T2040-0812** coupling one end and **T2090-0808** coupling other end.

Maximum Working Pressure of **T28D** is 350 bar.\*

Maximum Working Pressure of **T2040-0812** is 690 bar.\*

Maximum Working Pressure of **T2090-0808** is 690 bar.\*

The Maximum Working Pressure of the Hose Assembly is therefore 350 bar, the lowest of the respective Maximum Working Pressure rated values (in this case, the hose).

### EXAMPLE 2.

**H5016D** Hose Assembly with **T7130-1620** coupling one end and **T7030-1621** coupling other end.

Maximum Working Pressure of **H5016D** is 350 bar.\*

Maximum Working Pressure of **T7130-1620** is 280 bar.\*

Maximum Working Pressure of **T7030-1621** is 420 bar.\*

The Maximum Working Pressure of the Hose Assembly is therefore 280 bar, the lowest of the respective Maximum Working Pressure rated values (in this case, the **T7130-1620**).

## 33000 SERIES COUPLINGS FOR SRX/HT AND SRF/P SERIES HOSE

The Maximum Working Pressure of a **SRX/HT** or **SRF/P** Series Hose Assembly depends on the couplings used, and the method of attachment.\*

**33000** Series Couplings with **RSC** Clamps are suited to Suction Applications, and Low Pressure Delivery (up to 25% of Maximum Working Pressure of the hose).

**T4000** One-Piece Crimp Couplings are suited to Suction Applications, and High Pressure Delivery (up to 100% of Maximum Working Pressure of the hose).

### EXAMPLE:

**SRF20** Hose Assembly with **33020-2020** Couplings each end secured with **RSC-4347** Clamps.

Maximum Working Pressure of **SRF20** hose is 14 bar.\*

Maximum Working Pressure of **33020-2020** coupling is 215 bar.\*

Maximum Working Pressure of the Hose Assembly is 25% of 14 bar = 3,5 bar.

If this Hose Assembly was made with **T4020-2020** One-Piece Crimp Couplings instead:

Maximum Working Pressure of **SRF20** hose is 14 bar.\*

Maximum Working Pressure of **T4020-2020** coupling is 215 bar.\*

Maximum Working Pressure of the Hose Assembly is 100% of 14 bar = 14 bar.

\* Refer to **2025 Ryco Hydraulics Hoses Catalogue**

## 8000 SERIES COUPLINGS FOR PL1.

**PL1D**, **PL1PV** and **8000** Series Push-On Fittings, are recommended for use in systems with Static Working Pressures (constant loads without pressure spikes) only. They are not recommended for vibration or pressure surge applications.

**PL1D**, **PL1PV** hose should not be used at both maximum working pressure and maximum temperature simultaneously.

**8000** Series Push-On pages 202 to 209.

**PL1D**, **PL1PV** hose simply pushes on to **8000** Series Couplings, and for Static Working Pressures up to 50% of Maximum Static Working Pressures a clamp is not required. For diesel fuel and other potentially dangerous or critical applications, and Static Working Pressures above 50% of maximum; a clamp around the hose is required. Do not overtighten clamp as this will damage hose. Factory crimped couplings are also available in some sizes. Contact Ryco for more information.

## DROP LENGTH & CUT-OFF ALLOWANCE DIMENSIONS FOR COUPLINGS

In this Product Technical Manual, dimensional values for Drop Length (DL), Cut-off Allowance (CA), Seat to Ferrule (L), Back up Hex (AF), Male Hex (HM) and Female Hex (HF) are published.

Due to different manufacturing methods and design changes, DL, CA, L, AF, HM and HF values may vary from time to time.

Before attaching couplings to the hose, measure and check that the DL, CA and L dimensions of the actual coupling to be used complies with that published, or is suitable for the application.

**NOTE: Drop Length (DL), Cut-off Allowance (CA), Seat to Ferrule (L), Back up Hex (AF), Male Hex (HM) and Female Hex (HF) dimensions shown are for reference only, and may vary according to manufacturing method.**

## T2000 SERIES ONE-PIECE CRIMP COUPLINGS

### HOSE COMPATIBILITY FOR T2000 SERIES

#### NON-SKIVE

For Ryco Hose Series T3000D/S (sizes -04 to -16).  
 For Ryco Hose Series T3600D/S (sizes -04 to -16).  
 For Ryco Hose Series T4000D/S (sizes -04 to -12).  
 For Ryco Hose Series T5000D/S (sizes -04 to -08).  
 For Ryco Hose Series T6000D/S (sizes -04 to -06).  
 For Ryco Hose Series SURVIVOR/1 (sizes -04 to -16).  
 For Ryco Hose Series E1, E2/C, T1D/S, T2D/S (sizes -03 to -48).  
 For Ryco Hose Series TJD (sizes -24 to -26).  
 For Ryco Hose Series DF2D (sizes -04 to -20).

#### NON-SKIVE

For Ryco Hose Series D2B (sizes -24 to -32).  
 For Ryco Hose Series DK1D/E/S (sizes -04 to -20).  
 For Ryco Hose Series DK2D/E/S (sizes -04 to -20).  
 For Ryco Hose Series JS4000/B/G/BX/GX (sizes -04 to -08).  
 For Ryco Hose Series JS6000/B/G/BX/GX (sizes -04 to -08).  
 For Ryco Hose Series TW (sizes -04 to -08).  
 For Ryco Hose Series PW (sizes -04 to -06).  
 For Ryco Hose Series BT1 (sizes -04 to -16).  
 For Ryco Hose Series MS1000 (sizes -08 to -32).

### BSPT

### T2010

BSPT MALE  
60°SEAT

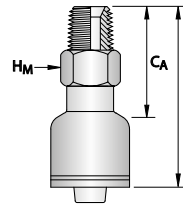

PART NO.	HOSE SIZE		THREAD SIZE	TUBE SIZE	DASH SIZE	DIMENSIONS				SPANNER			
	DN	inch				inch	inch	mm	inch	mm	inch	mm	
T2010-0302	5	3/16	1/8" -28		-0302	1.73	44	0.98	25			1/2	
T2010-0402	6	1/4	1/8" -28		-0402	2.01	51	1.02	26			1/2	
T2010-0404	6	1/4	1/4" -19		-0404	2.17	55	1.18	30			9/16	
T2010-0406	6	1/4	3/8" -19		-0406	2.17	55	1.18	30			11/16	
T2010-0408	6	1/4	1/2" -14		-0408	2.36	60	1.38	35			7/8	22
T2010-0506	8	5/16	3/8" -19		-0506	2.17	55	1.18	30			11/16	
T2010-0508	8	5/16	1/2" -14		-0508	2.36	60	1.38	35	-		7/8	22
T2010-0604	10	3/8	1/4" -19		-0604	2.24	57	1.30	33			5/8	16
T2010-0606	10	3/8	3/8" -19		-0606	2.24	57	1.30	33			11/16	
T2010-0608	10	3/8	1/2" -14		-0608	2.44	62	1.46	37			7/8	22
T2010-0806	12	1/2	3/8" -19		-0806	2.32	59	1.38	35			11/16	
T2010-0808	12	1/2	1/2" -14		-0808	2.52	64	1.57	40			7/8	22
T2010-0810	12	1/2	5/8" -14		-0810	2.52	64	1.57	40			1	
T2010-0812	12	1/2	3/4" -14		-0812	2.60	66	1.61	41			1.1/16	27
T2010-1008	16	5/8	1/2" -14		-1008	2.80	71	1.61	41			7/8	22
T2010-1010	16	5/8	5/8" -14		-1010	2.80	71	1.61	41			1	
T2010-1012	16	5/8	3/4" -14		-1012	2.80	71	1.61	41			1.1/16	27
T2010-1212	19	3/4	3/4" -14		-1212	2.80	71	1.61	41			1.1/16	27
T2010-1216	19	3/4	1" -11		-1216	2.99	76	1.81	46			1.3/8	35
T2010-1616	25	1	1" -11		-1616	3.11	79	1.89	48			1.3/8	35
T2010-1620	25	1	1.1/4" -11		-1620	3.23	82	2.01	51			1.3/4	
T2010-2020	31	1.1/4	1.1/4" -11		-2020	4.06	103	2.09	53			1.3/4	
T2010-2424	38	1.1/2	1.1/2" -11		-2424	4.21	107	2.17	55			2	50
T2010-3232	51	2	2" -11		-3232	4.80	122	2.60	66			2.1/2	
T2010-4040	63	2.1/2	2 1/2" -11		-4040	5.87	149	2.83	72			3	76

INTRODUCTION

INDEXES

ONE-PIECE COUPLINGS

PUSH-ON SUCTION & RETURN COUPLINGS

FIELD ATTACHABLE COUPLINGS

HYDRAULIC FITTINGS ACCESSORIES

# ONE-PIECE COUPLINGS

## T2000 SERIES ONE-PIECE CRIMP COUPLINGS

BSPP

T2013

BSPP MALE  
60° SEAT

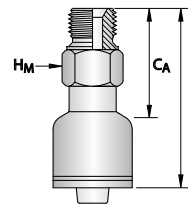

PART NO.	HOSE SIZE		THREAD SIZE	TUBE SIZE	DASH SIZE	DIMENSIONS				SPANNER					
	DN	inch	inch			L		C <sub>A</sub>		D <sub>L</sub>		H <sub>F</sub>		H <sub>M</sub>	
						inch	mm	inch	mm					inch	mm
T2013-0302	5	3/16	1/8" -28		-0302	1.65	42	0.87	22					5/8	16
T2013-0304	5	3/16	1/4" -19		-0304	1.89	48	1.10	28					3/4	19
T2013-0402	6	1/4	1/8" -28		-0402	1.97	50	0.94	24						14
T2013-0404	6	1/4	1/4" -19		-0404	2.09	53	1.10	28					3/4	19
T2013-0406	6	1/4	3/8" -19		-0406	2.09	53	1.10	28					7/8	22
T2013-0408	6	1/4	1/2" -14		-0408	2.28	58	1.30	33					1.1/16	27
T2013-0504	8	5/16	1/4" -19		-0504	2.09	53	1.10	28					3/4	19
T2013-0506	8	5/16	3/8" -19		-0506	2.13	54	1.14	29					7/8	22
T2013-0604	10	3/8	1/4" -19		-0604	2.09	53	1.10	28					3/4	19
T2013-0606	10	3/8	3/8" -19		-0606	2.13	54	1.14	29					7/8	22
T2013-0608	10	3/8	1/2" -14		-0608	2.28	58	1.30	33					1.1/16	27
T2013-0806	12	1/2	3/8" -19		-0806	2.17	55	1.18	30					7/8	22
T2013-0808	12	1/2	1/2" -14		-0808	2.28	58	1.34	34					1.1/16	27
T2013-0810	12	1/2	5/8" -14		-0810	2.40	61	1.42	36					1.3/16	30
T2013-0812	12	1/2	3/4" -14		-0812	2.48	63	1.54	39					1.1/4	32
T2013-1008	16	5/8	1/2" -14		-1008	2.52	64	1.30	33					1.1/16	27
T2013-1010	16	5/8	5/8" -14		-1010	2.64	67	1.46	37					1.3/16	30
T2013-1012	16	5/8	3/4" -14		-1012	2.72	69	1.50	38					1.1/4	32
T2013-1208	19	3/4	1/2" -14		-1208	2.52	64	1.34	34					1.1/16	27
T2013-1212	19	3/4	3/4" -14		-1212	2.72	69	1.54	39					1.1/4	32
T2013-1612	25	1	3/4" -14		-1612	2.80	71	1.57	40					1.1/4	32
T2013-1616	25	1	1" -11		-1616	2.95	75	1.77	45					1.5/8	41
T2013-1620	25	1	1.1/4" -11		-1620	3.15	80	1.93	49					2	50
T2013-2020	31	1.1/4	1.1/4" -11		-2020	3.98	101	2.01	51					2	50
T2013-2424	38	1.1/2	1.1/2" -11		-2424	4.17	106	2.13	54					2.3/16	55
T2013-2432	38	1.1/2	2" -11		-2432	4.65	118	2.64	67					2.3/4	70
T2013-3232	51	2	2" -11		-3232	4.84	123	2.64	67					2.3/4	70

## T2000 SERIES ONE-PIECE CRIMP COUPLINGS

**BSPP**

**T2017**

BSPP MALE  
ENCAPSULATED SEAL

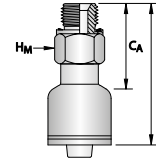

PART NO.	HOSE SIZE		THREAD SIZE	TUBE SIZE	DASH SIZE	DIMENSIONS				SPANNER					
	DN	inch	inch			L		C <sub>A</sub>		D <sub>L</sub>		H <sub>F</sub>		H <sub>M</sub>	
						inch	mm	inch	mm			inch	mm	inch	mm
T2017-0404	6	1/4	1/4" -19		-0404	2.17	55	1.18	30					3/4	19
T2017-0606	10	3/8	3/8" -19		-0606	2.13	54	1.18	30					7/8	22
T2017-0808	12	1/2	1/2" -14		-0808	2.36	60	1.38	35					1.1/16	27
T2017-1212	19	3/4	3/4" -14		-1212	2.72	69	1.54	39					1.1/4	32
T2017-1616	25	1	1" -11		-1616	2.95	75	1.77	45					1.5/8	41
T2017-2020	31	1.1/4	1.1/4" -11		-2020	3.98	101	2.01	51					2	50

**BSPP**

**T2020**

BSPP FEMALE  
60° CONE

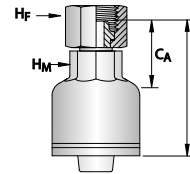

PART NO.	HOSE SIZE		THREAD SIZE	TUBE SIZE	DASH SIZE	DIMENSIONS				SPANNER					
	DN	inch	inch			L		C <sub>A</sub>		D <sub>L</sub>		H <sub>F</sub>		H <sub>M</sub>	
						inch	mm	inch	mm			inch	mm	inch	mm
T2020-0302	5	3/16	1/8" -28		-0302	1.61	41	0.83	21					7/16	11
T2020-0304	5	3/16	1/4" -19		-0304	1.61	41	0.87	22			3/4	19	1/2	
T2020-0402	6	1/4	1/8" -28		-0402	1.93	49	0.91	23					1/2	
T2020-0404	6	1/4	1/4" -19		-0404	1.93	49	0.94	24			3/4	19	1/2	
T2020-0406	6	1/4	3/8" -19		-0406	2.05	52	1.02	26			7/8	22	5/8	16
T2020-0504	8	5/16	1/4" -19		-0504	1.85	47	0.87	22			3/4	19	9/16	
T2020-0506	8	5/16	3/8" -19		-0506	1.93	49	0.94	24			7/8	22	5/8	16
T2020-0604	10	3/8	1/4" -19		-0604	1.93	49	0.94	24			3/4	19	5/8	16
T2020-0606	10	3/8	3/8" -19		-0606	2.05	52	1.06	26			7/8	22	5/8	16
T2020-0608	10	3/8	1/2" -14		-0608	2.09	55	1.10	30			1.1/16	27	3/4	19
T2020-0806	12	1/2	3/8" -19		-0806	2.05	52	1.06	27			7/8	22	3/4	19
T2020-0808	12	1/2	1/2" -14		-0808	2.09	53	1.10	28			1.1/16	27	3/4	19
T2020-0812	12	1/2	3/4" -14		-0812	2.13	57	1.18	32			1.1/4	32	1	
T2020-1008	16	5/8	1/2" -14		-1008	2.40	61	1.18	30			1.1/16	27	7/8	22
T2020-1010	16	5/8	5/8" -14		-1010	2.36	60	1.14	29			1.3/16	30	7/8	22
T2020-1012	16	5/8	3/4" -14		-1012	2.28	58	1.06	27			1.1/4	32	1	
T2020-1208	19	3/4	1/2" -14		-1208	2.52	64	1.30	33			1.1/16	27	15/16	24
T2020-1212	19	3/4	3/4" -14		-1212	2.44	60	1.30	31			1.1/4	32	1.1/16	27
T2020-1216	19	3/4	1" -11		-1216	2.72	67	1.54	37			1.1/2	38	1.1/16	27
T2020-1612	25	1	3/4" -14		-1612	2.56	65	1.34	34			1.1/4	32	1.1/4	32
T2020-1616	25	1	1" -11		-1616	2.68	68	1.46	36			1.1/2	38	1.1/4	32
T2020-1620	25	1	1.1/4" -11		-1620	2.91	74	1.69	43			2	50	1.1/4	37
T2020-2020	31	1.1/4	1.1/4" -11		-2020	3.70	94	1.77	45			2	50	1.5/8	41
T2020-2424	38	1.1/2	1.1/2" -11		-2424	3.90	99	1.85	47			2.3/16	55	2	50
T2020-3232	51	2	2" -11		-3232	4.33	110	2.13	54			2.3/4	70	2.1/2	
T2020-4040	63	2.1/2	2 1/2" -11		-4040	4.72	120	1.73	44			3.1/2	90		

# ONE-PIECE COUPLINGS

## T2000 SERIES ONE-PIECE CRIMP COUPLINGS

**BSPT**

**T2320**

BSPT MALE SWIVEL

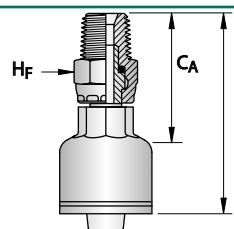

PART NO.	HOSE SIZE		THREAD SIZE	TUBE SIZE	DASH SIZE	DIMENSIONS						SPANNER			
	DN	inch	inch			L		CA		DL		HF		HM	
	DN	inch	inch			inch	mm	inch	mm	inch	mm	inch	mm	inch	mm
T2320-0606	10	3/8	3/8" -19		-0606	2.32	59	1.34	34			7/8	22		
T2320-0608	10	3/8	1/2" -14		-0608	2.32	59	1.34	34			1			
T2320-0808	12	1/2	1/2" -14		-0808	2.80	71	1.81	46			1			

**BSPT**

**T2340**

BSPT MALE SWIVEL  
90° ELBOW

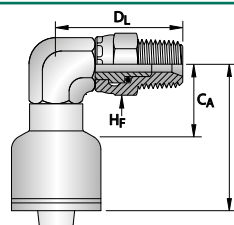

PART NO.	HOSE SIZE		THREAD SIZE	TUBE SIZE	DASH SIZE	DIMENSIONS						SPANNER			
	DN	inch	inch			L		CA		DL		HF		HM	
	DN	inch	inch			inch	mm	inch	mm	inch	mm	inch	mm	inch	mm
T2340-0606	10	3/8	3/8" -19		-0606	1.89	48	0.91	23	1.77	45	7/8	22	3/4	19
T2340-0608	10	3/8	1/2" -14		-0608	1.89	48	0.91	23	1.97	50	1		3/4	19
T2340-0808	12	1/2	1/2" -14		-0808	2.13	54	1.14	29	2.05	52	1		7/8	22
T2340-1212	19	3/4	3/4" -14		-1212	2.36	60	1.22	31	1.77	45	1.1/4	32	1.1/16	27

**BSPP**

**T2028B**

BSPP FEMALE  
LIVE SWIVEL  
60° CONE

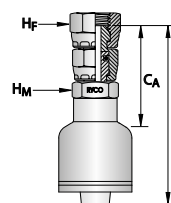

PART NO.	HOSE SIZE		THREAD SIZE	TUBE SIZE	DASH SIZE	DIMENSIONS						SPANNER			
	DN	inch	inch			L		CA		DL		HF		HM	
	DN	inch	inch			inch	mm	inch	mm	inch	mm	inch	mm	inch	mm
T2028B-0404	6	1/4	1/4" -19		-0404	2.64	67	1.61	41			3/4	19	11/16	
T2028B-0604	10	3/8	1/4" -19		-0604	2.60	66	1.65	42			3/4	19	11/16	

## T2000 SERIES ONE-PIECE CRIMP COUPLINGS

**BSPP**

**T2024**

BSPP FEMALE  
FLAT FACE

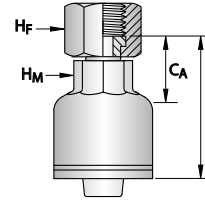

PART NO.	HOSE SIZE		THREAD SIZE	TUBE SIZE	DASH SIZE	DIMENSIONS						SPANNER			
	DN	inch	inch			L		C <sub>A</sub>		D <sub>L</sub>		H <sub>F</sub>		H <sub>M</sub>	
	DN	inch	inch			inch	mm	inch	mm			inch	mm	inch	mm
T2024-0404	6	1/4	1/4" -19		-0404	1.85	47	0.87	22			3/4	19	1/2	
T2024-0606	10	3/8	3/8" -19		-0606	1.93	49	0.94	24			7/8	22	5/8	16
T2024-0608	10	3/8	1/2" -14		-0608	1.81	46	0.83	21			1.1/16	27	3/4	19
T2024-0808	12	1/2	1/2" -14		-0808	1.85	47	0.87	22			1.1/16	27	3/4	19
T2024-0812	12	1/2	3/4" -14		-0812	2.09	53	1.10	28			1.1/4	32	1	
T2024-1212	19	3/4	3/4" -14		-1212	2.28	58	1.14	29			1.1/4	32	1	
T2024-1216	19	3/4	1" -11		-1216	2.40	61	1.26	32			1.1/2	38	1.1/4	32
T2024-1616	25	1	1" -11		-1616	2.52	64	1.30	33			1.1/2	38	1.1/4	32

**BSPP**

**T2060**

BSPP FEMALE  
60° CONE  
45° ELBOW

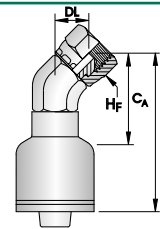

PART NO.	HOSE SIZE		THREAD SIZE	TUBE SIZE	DASH SIZE	DIMENSIONS						SPANNER			
	DN	inch	inch			L		C <sub>A</sub>		D <sub>L</sub>		H <sub>F</sub>		H <sub>M</sub>	
	DN	inch	inch			inch	mm	inch	mm	inch	mm	inch	mm	inch	mm
T2060-0404	6	1/4	1/4" -19		-0404	1.57	40	0.55	14	0.59	15	3/4	19	9/16	
T2060-0606	10	3/8	3/8" -19		-0606	1.65	42	0.67	17	0.71	18	7/8	22	3/4	19
T2060-0808	12	1/2	1/2" -14		-0808	1.81	46	0.83	21	0.71	18	1.1/16	27	7/8	22
T2060-1212	19	3/4	3/4" -14		-1212	2.13	54	0.98	25	0.79	20	1.1/4	32	1.1/16	27
T2060-1616	25	1	1" -11		-1616	2.32	59	1.10	28	1.02	26	1.1/2	38	1.5/16	
T2060-2020	31	1.1/4	1.1/4" -11		-2020	3.07	78	1.10	28	1.14	29	2	50	1.7/8	

**BSPP**

**T2475**

BSP BANJO STRAIGHT

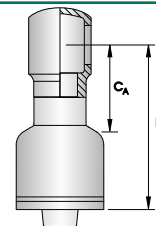

PART NO.	HOSE SIZE		THREAD SIZE	TUBE SIZE	DASH SIZE	DIMENSIONS						SPANNER			
	DN	inch	inch			L		C <sub>A</sub>		D <sub>L</sub>		H <sub>F</sub>		H <sub>M</sub>	
	DN	inch	inch			inch	mm	inch	mm	inch	mm				
T2475-0404	6	1/4	1/4		0	-0404	1.97	50	0.98	25					

# ONE-PIECE COUPLINGS

## T2000 SERIES ONE-PIECE CRIMP COUPLINGS

**BSPP**

**T2050**

BSPP FEMALE  
60° CONE  
90° ELBOW

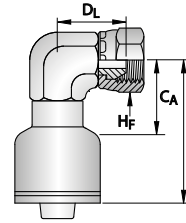

PART NO.	HOSE SIZE		THREAD SIZE	TUBE SIZE	DASH SIZE	DIMENSIONS						SPANNER			
	DN	inch	inch			L		C <sub>A</sub>		D <sub>L</sub>		H <sub>F</sub>		H <sub>M</sub>	
	DN	inch	inch			inch	mm	inch	mm	inch	mm	inch	mm	inch	mm
T2050-0404	6	1/4	1/4" -19		-0404	1.85	47	0.83	21	0.94	24	3/4	19	9/16	
T2050-0406	6	1/4	3/8" -19		-0406	1.85	47	0.83	21	1.10	28	7/8	22	3/4	19
T2050-0506	8	5/16	3/8" -19		-0506	1.85	47	0.87	22	1.10	28	7/8	22	3/4	19
T2050-0604	10	3/8	1/4" -19		-0604	1.81	46	0.87	22	0.94	24	3/4	19	9/16	
T2050-0606	10	3/8	3/8" -19		-0606	1.89	48	0.91	23	1.10	28	7/8	22	3/4	19
T2050-0608	10	3/8	1/2" -14		-0608	1.89	48	0.91	23	1.22	31	1.1/16	27	7/8	22
T2050-0808	12	1/2	1/2" -14		-0808	2.13	54	1.14	29	1.22	31	1.1/16	27	7/8	22
T2050-1212	19	3/4	3/4" -14		-1212	2.36	60	1.22	31	1.42	36	1.1/4	32	1.1/16	27
T2050-1616	25	1	1" -11		-1616	2.48	63	1.26	32	1.77	45	1.1/2	38	1.5/16	
T2050-2020	31	1.1/4	1.1/4" -11		-2020	3.66	93	1.69	43	2.05	52	2	50	1.7/8	
T2050-2424	38	1.1/2	1.1/2" -11		-2424	4.41	112	2.36	60	2.32	59	2.3/16	55	2.1/2	
T2050-3232	51	2	2" -11		-3232	4.45	113	2.20	56	2.44	62	2.3/4	70	2.1/2	

**BSPP**

**T2270**

BSPP FEMALE  
60° CONE  
45° TUBE BEND

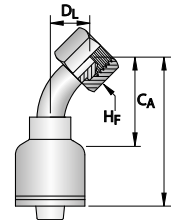

PART NO.	HOSE SIZE		THREAD SIZE	TUBE SIZE	DASH SIZE	DIMENSIONS						SPANNER			
	DN	inch	inch			L		C <sub>A</sub>		D <sub>L</sub>		H <sub>F</sub>		H <sub>M</sub>	
	DN	inch	inch			inch	mm	inch	mm	inch	mm	inch	mm	inch	mm
T2270-0404	6	1/4	1/4" -19		-0404	2.36	60	1.38	35	0.67	17	3/4	19		
T2270-0406	6	1/4	3/8" -19		-0406	2.44	62	1.46	37	0.67	17	7/8	22		
T2270-0506	8	5/16	3/8" -19		-0506	2.60	66	1.61	41	0.71	18	7/8	22		
T2270-0606	10	3/8	3/8" -19		-0606	2.60	66	1.61	41	0.71	18	7/8	22		
T2270-0608	10	3/8	1/2" -14		-0608	2.76	70	1.77	45	0.79	20	1.1/16	27		
T2270-0808	12	1/2	1/2" -14		-0808	2.95	75	1.97	50	0.87	22	1.1/16	27		
T2270-0810	12	1/2	5/8" -14		-0810	2.91	74	1.93	49	0.91	23	1.3/16	30		
T2270-1010	16	5/8	5/8" -14		-1010	3.66	93	2.44	62	0.91	23	1.3/16	30		
T2270-1012	16	5/8	3/4" -14		-1012	3.50	89	2.28	58	1.10	28	1.1/4	32		
T2270-1212	19	3/4	3/4" -14		-1212	4.25	106	3.11	77	1.14	29	1.1/4	32		
T2270-1616	25	1	1" -11		-1616	4.57	116	3.35	83	1.65	42	1.1/2	38		32
T2270-2020	31	1.1/4	1.1/4" -11		-2020	8.46	215	6.50	165	1.81	46	2	50		
T2270-2424	38	1.1/2	1.1/2" -11		-2424	6.69	170	4.65	118	2.05	52	2.3/16	55		
T2270-3232	51	2	2" -11		-3232	8.11	206	5.91	150	2.56	65	2.3/4	70		

## T2000 SERIES ONE-PIECE CRIMP COUPLINGS

**BSPP**

**T2260**

BSPP FEMALE  
60° CONE  
90° TUBE BEND

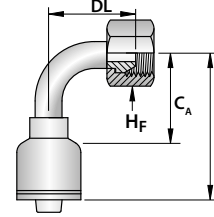

PART NO.	HOSE SIZE		THREAD SIZE	TUBE SIZE	DASH SIZE	DIMENSIONS						SPANNER		
	DN	inch	inch			L		CA		DL		HF		HM
						inch	mm	inch	mm	inch	mm	inch	mm	
T2260-0302	5	3/16	1/8"-28		-0302	1.85	47	1.06	27	1.10	28		14	
T2260-0304	5	3/16	1/4"-19		-0302	1.85	47	1.06	27	1.14	29	3/4	19	
T2260-0402	6	1/4	1/8"-28		-0402	2.05	52	1.06	27	1.18	30		14	
T2260-0404	6	1/4	1/4"-19		-0404	2.05	52	1.06	27	1.14	29	3/4	19	
T2260-0406	6	1/4	3/8"-19		-0406	2.05	52	1.06	27	1.10	28	7/8	22	
T2260-0504	8	5/16	1/4"-19		-0504	2.05	52	1.06	27	1.26	32	3/4	19	
T2260-0506	8	5/16	3/8"-19		-0506	2.32	59	1.34	34	1.30	33	7/8	22	
T2260-0604	10	3/8	1/4"-19		-0604	2.36	60	1.38	35	1.30	33	3/4	19	
T2260-0606	10	3/8	3/8"-19		-0606	2.32	59	1.38	35	1.30	33	7/8	22	
T2260-0608	10	3/8	1/2"-14		-0608	2.32	59	1.38	35	1.30	33	1.1/16	27	
T2260-0806	12	1/2	3/8"-19		-0806	2.60	66	1.61	41	1.65	42	7/8	22	
T2260-0808	12	1/2	1/2"-14		-0808	2.48	66	1.50	41	1.77	45	1.1/16	27	
T2260-0810	12	1/2	5/8"-14		-0810	2.60	66	1.61	41	1.77	45	1.3/16	30	
T2260-0812	12	1/2	3/4"-14		-0812	2.60	66	1.61	41	1.85	47	1.1/4	32	
T2260-1010	16	5/8	5/8"-14		-1010	2.99	76	1.77	45	1.97	50	1.3/16	30	
T2260-1012	12	1/2	3/4"-14		-1012	2.99	76	1.77	45	2.20	56	1.1/4	32	
T2260-1208	19	3/4	1/2"-14		-1208	3.35	85	2.09	53	1.77	45		27	
T2260-1212	19	3/4	3/4"-14		-1212	3.35	87	2.17	57	2.32	59	1.1/4	32	
T2260-1216	19	3/4	1"-11		-1216	3.50	89	2.24	57	2.44	62	1.1/2	38	
T2260-1616	25	1	1"-11		-1616	3.90	99	2.68	74	3.07	78	1.1/2	38	32
T2260-2016	31	1.1/4	1"-11		-2016	5.47	139	3.54	90	3.03	77	1.1/2	38	
T2260-2020	31	1.1/4	1.1/4"-11		-2020	5.20	132	3.23	82	3.58	91	2	50	
T2260-2424	38	1.1/2	1.1/2"-11		-2424	5.91	150	3.86	98	4.13	105	2.3/16	55	
T2260-3232	51	2	2"-11		-3232	7.60	193	5.39	137	5.20	132	2.3/4	70	

**BSPP**

**T2210**

BSPP FEMALE  
60° CONE  
90° LONG TUBE BEND

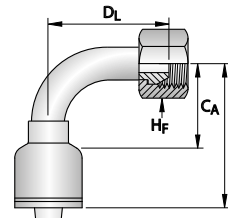

PART NO.	HOSE SIZE		THREAD SIZE	TUBE SIZE	DASH SIZE	DIMENSIONS						SPANNER		
	DN	inch	inch			L		CA		DL		HF		HM
						inch	mm	inch	mm	inch	mm	inch	mm	
T2210-0404	6	1/4	1/4"-19		-0404	3.35	85	2.36	60	2.01	51	3/4	19	
T2210-0606	10	3/8	3/8"-19		-0606	2.91	74	1.93	49	2.32	59	7/8	22	
T2210-0808	12	1/2	1/2"-14		-0808	3.35	85	2.36	60	2.83	72	1.1/16	27	
T2210-0810	12	1/2	5/8"-14		-0810	2.80	71	1.81	46	2.83	72	1.3/16	30	
T2210-1010	16	5/8	5/8"-14		-1010	3.23	82	2.01	51	3.19	81	1.3/16	30	
T2210-1212	19	3/4	3/4"-14		-1212	3.50	87	2.32	57	3.74	95	1.1/4	32	
T2210-1616	25	1	1"-11		-1616	3.78	96	2.56	74	4.57	116	1.1/2	38	
T2210-2020	31	1.1/4	1.1/4"-11		-2020	5.87	149	3.94	100	5.59	142	2	50	

# ONE-PIECE COUPLINGS

## T2000 SERIES ONE-PIECE CRIMP COUPLINGS

**BSPP**

**T2027**

BSPP FEMALE O RING  
60° CONE

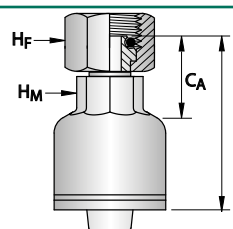

PART NO.	HOSE SIZE		THREAD SIZE	TUBE SIZE	DASH SIZE	DIMENSIONS						SPANNER			
	DN	inch	inch			L		C <sub>A</sub>		D <sub>L</sub>		H <sub>F</sub>		H <sub>M</sub>	
						inch	mm	inch	mm	inch	mm	inch	mm	inch	mm
T2027-0404	6	1/4	1/4" -19		-0404	1.89	48	0.91	23	0	0	3/4	19	1/2	0
T2027-0406	6	1/4	3/8" -19		-0406	2.04	52	1.06	27	29	29	7/8	22	1/2	0
T2027-0808	12	1/2	1/2" -14		-0808	2.09	53	1.10	28	33	33	1 1/16	27	3/4	0
T2027-1212	12	1/2	3/4" -14		-1212	2.44	60	1.30	31	450	450	1 1/4	32	1 1/16	24
T2027-1616	25	1	1" -11		-1616	2.72	69	1.50	36	59	59	1 1/2	38	1 1/4	0
T2027-2020	31	1.1/4	1.1/4" -11		-2020	3.70	94	1.77	45	78	78	2	50	1/5/8	0
T2027-2424	38	1.1/2	1.1/2" -11		-2424	3.90	99	1.85	47	91	91	2 3/16	55	2	0
T2027-3232	51	2	2" -11		-3232	4.37	111	2.17	55	105	105	2 3/4	70	0	0

**BSPP**

**T2057**

BSPP  
FEMALE O RING  
60° CONE  
90° ELBOW

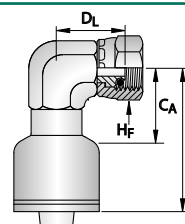

PART NO.	HOSE SIZE		THREAD SIZE	TUBE SIZE	DASH SIZE	DIMENSIONS						SPANNER			
	DN	inch	inch			L		C <sub>A</sub>		D <sub>L</sub>		H <sub>F</sub>		H <sub>M</sub>	
						inch	mm	inch	mm	inch	mm	inch	mm	inch	mm
T2057-0404	6	1/4	1/4" -19		-0404	1.85	47	0.83	21	0.94	24	3/4	19	9/16	
T2057-0606	10	3/8	3/8" -19		-0606	1.89	48	0.91	23	1.10	28	7/8	22	3/4	19
T2057-0808	12	1/2	1/2" -14		-0808	2.13	54	1.14	29	1.30	33	1.1/16	27	7/8	22
T2057-1212	19	3/4	3/4" -14		-1212	2.36	60	1.18	30	1.50	38	1.1/4	32	1.1/16	27

## T2000 SERIES ONE-PIECE CRIMP COUPLINGS

**BSPP**

**T2277**

BSPP FEMALE O RING  
60° CONE  
45° TUBE BEND

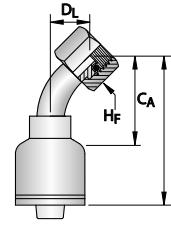

PART NO.	HOSE SIZE		THREAD SIZE	TUBE SIZE	DASH SIZE	DIMENSIONS						SPANNER			
	DN	inch	inch			L		C <sub>A</sub>		D <sub>L</sub>		H <sub>F</sub>		H <sub>M</sub>	
	DN	inch	inch			inch	mm	inch	mm	inch	mm	inch	mm	inch	mm
T2277-0404	6	1/4	1/4" -19		-0404	2.56	65	1.57	40	0.67	17	3/4	19	0	0
T2277-0606	10	3/8	3/8" -19		-0606	2.60	66	1.61	41	0.71	18	7/8	22	0	0
T2277-0808	12	1/2	1/2" -14		-0808	2.95	75	1.97	50	0.87	22	1 1/16	27	0	0
T2277-1212	19	3/4	3/4" -14		-1212	4.25	106	3.11	77	1.14	29	1 1/4	32	0	0
T2277-1616	25	1	1" -11		-1616	4.57	116	3.35	83	1.65	42	1 1/2	38	0	0
T2277-2020	31	1.1/4	1.1/4" -11		-2020	8.46	215	6.50	165	1.81	46	2	50	0	0
T2277-2424	38	1.1/2	1.1/2" -11		-2424	7.09	180	5.04	128	2.05	52	2 3/16	55	0	0
T2277-3232	51	2	2" -11		-3232	8.11	206	5.91	150	2.56	65	2 3/4	70	0	0

**BSPP**

**T2267**

BSPP FEMALE O RING  
60° CONE  
90° TUBE BEND

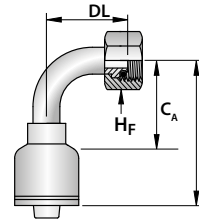

PART NO.	HOSE SIZE		THREAD SIZE	TUBE SIZE	DASH SIZE	DIMENSIONS						SPANNER			
	DN	inch	inch			L		C <sub>A</sub>		D <sub>L</sub>		H <sub>F</sub>		H <sub>M</sub>	
	DN	inch	inch			inch	mm	inch	mm	inch	mm	inch	mm	inch	mm
T2267-0404	6	1/4	1/4" -19		-0404	2.24	57	1.26	32	0.67	17	3/4	19	0	0
T2267-0606	10	3/8	3/8" -19		-0606	2.36	60	1.38	35	0.71	18	7/8	22	0	0
T2267-0808	12	1/2	1/2" -14		-0808	2.60	66	1.61	41	0.87	22	1 1/16	27	0	0
T2267-1212	19	3/4	3/4" -14		-1212	3.50	87	2.32	57	1.14	29	1 1/4	32	0	0
T2267-1616	25	1	1" -11		-1616	3.90	99	2.68	74	1.65	42	1 1/2	38	0	0
T2267-2020	31	1.1/4	1.1/4" -11		-2020	5.87	149	3.94	100	1.81	46	2	50	0	0
T2267-2424	38	1.1/2	1.1/2" -11		-2424	6.22	158	4.17	106	2.05	52	2 3/16	55	0	0
T2267-3232	51	2	2" -11		-3232	7.61	193	5.39	137	2.56	65	2 3/4	70	0	0

INTRODUCTION

INDEXES

ONE-PIECE COUPLINGS

PUSH-ON SUCTION & RETURN COUPLINGS

FIELD ATTACHABLE COUPLINGS

HYDRAULIC FITTINGS ACCESSORIES

# ONE-PIECE COUPLINGS

## T2000 SERIES ONE-PIECE CRIMP COUPLINGS

**NPTF**

**T2090**

NPTF MALE  
60° SEAT

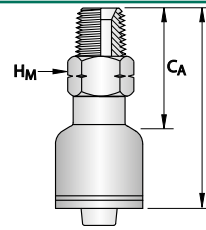

PART NO.	HOSE SIZE		THREAD SIZE	TUBE SIZE	DASH SIZE	DIMENSIONS				SPANNER			
	DN	inch	inch			L		CA		DL	HF	HM	
						inch	mm	inch	mm			inch	mm
T2090-0302	5	3/16	1/8" -27		-0302	1.73	44	0.94	24			7/16	11
T2090-0304	5	3/16	1/4" -18		-0304	1.97	50	1.18	30			9/16	
T2090-0402	6	1/4	1/8" -27		-0402	2.01	51	1.02	26			1/2	
T2090-0404	6	1/4	1/4" -18		-0404	2.17	55	1.18	30			9/16	
T2090-0406	6	1/4	3/8" -18		-0406	2.17	55	1.18	30			11/16	
T2090-0408	6	1/4	1/2" -14		-0408	2.28	58	1.26	32			7/8	22
T2090-0504	8	5/16	1/4" -18		-0504	2.17	55	1.18	30			9/16	
T2090-0506	8	5/16	3/8" -18		-0506	2.17	55	1.18	30			11/16	
T2090-0604	10	3/8	1/4" -18		-0604	2.24	57	1.30	33			5/8	16
T2090-0606	10	3/8	3/8" -18		-0606	2.24	57	1.30	33			11/16	
T2090-0608	10	3/8	1/2" -14		-0608	2.44	62	1.46	37			7/8	22
T2090-0806	12	1/2	3/8" -18		-0806	2.32	59	1.38	35			11/16	
T2090-0808	12	1/2	1/2" -14		-0808	2.52	64	1.57	40			7/8	22
T2090-0812	12	1/2	3/4" -14		-0812	2.40	61	1.46	37			1.1/16	27
T2090-1008	16	5/8	1/2" -14		-1008	2.80	71	1.61	41			7/8	22
T2090-1012	16	5/8	3/4" -14		-1012	2.80	71	1.61	41			1.1/16	27
T2090-1208	19	3/4	1/2" -14		-1208	2.80	71	1.61	41			1.1/16	27
T2090-1212	19	3/4	3/4" -14		-1212	2.80	71	1.61	41			1.1/16	27
T2090-1216	19	3/4	1" -11,5		-1216	2.87	73	1.73	44			1.3/8	35
T2090-1612	25	1	3/4" -14		-1612	2.91	74	1.69	43			1.3/8	35
T2090-1616	25	1	1" -11,5		-1616	3.11	79	1.89	48			1.3/8	35
T2090-1620	25	1	1.1/4" -11,5		-1620	2.99	76	1.81	46			1.3/4	
T2090-2016	31	1.1/4	1" -11,5		-2016	4.02	102	2.05	52			1.3/4	
T2090-2020	31	1.1/4	1.1/4" -11,5		-2020	4.06	103	2.09	53			1.3/4	
T2090-2424	38	1.1/2	1.1/2" -11,5		-2424	4.21	107	2.17	55			2	50
T2090-3232	51	2	2" -11,5		-3232	4.80	122	2.60	66			2.1/2	

**NPTF**

**T2091**

NPTF MALE EXTENDED

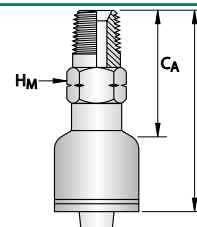

PART NO.	HOSE SIZE		THREAD SIZE	TUBE SIZE	DASH SIZE	DIMENSIONS				SPANNER			
	DN	inch	inch			L		CA		DL	HF	HM	
						inch	mm	inch	mm			inch	mm
T2091-0406	6	1/4	3/8" -18		-0406	2.48	63	1.50	38			3/4	19
T2091-0606	10	3/8	3/8" -18		-0606	2.56	65	1.57	40			3/4	19

## T2000 SERIES ONE-PIECE CRIMP COUPLINGS

**NPTF**

**T2320N**

NPTF MALE SWIVEL

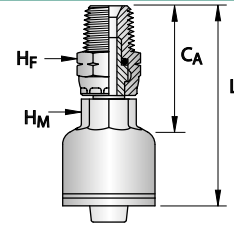

PART NO.	HOSE SIZE		THREAD SIZE	TUBE SIZE	DASH SIZE	DIMENSIONS						SPANNER			
	DN	inch	inch			L		C <sub>A</sub>		D <sub>L</sub>		H <sub>F</sub>		H <sub>M</sub>	
						inch	mm	inch	mm			inch	mm		
T2320N-0402	6	1/4	1/8" -27		-0402	2.13	54	1.14	29			11/16			
T2320N-0404	6	1/4	1/4" -18		-0404	2.13	54	1.14	29			11/16			
T2320N-0406	6	1/4	3/8" -18		-0406	2.32	59	1.34	34			7/8	22		
T2320N-0604	10	3/8	1/4" -18		-0604	2.13	54	1.14	29			11/16			
T2320N-0606	10	3/8	3/8" -18		-0606	2.32	59	1.34	34			7/8	22		
T2320N-0608	10	3/8	1/2" -14		-0608	2.32	59	1.34	34			1			
T2320N-0806	12	1/2	3/8" -18		-0806	2.32	59	1.38	35			7/8	22		
T2320N-0808	12	1/2	1/2" -14		-0808	2.32	59	1.38	35			1			
T2320N-1212	19	3/4	3/4" -14		-1212	2.60	66	1.46	37			1.1/4	32		
T2320N-1616	25	1	1" -11,5		-1616	2.91	74	1.69	43			1.1/2	38		

**NPT**

**T2340N**

NPT MALE SWIVEL  
90° ELBOW

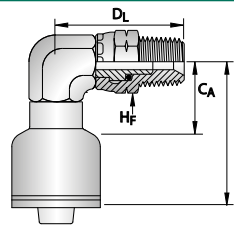

PART NO.	HOSE SIZE		THREAD SIZE	TUBE SIZE	DASH SIZE	DIMENSIONS						SPANNER			
	DN	inch	inch			L		C <sub>A</sub>		D <sub>L</sub>		H <sub>F</sub>		H <sub>M</sub>	
						inch	mm	inch	mm	inch	mm	inch	mm	inch	mm
T2340N-0404	6	1/4	1/4" -18		-0404	1.85	47	0.83	21	1.61	41	11/16		9/16	
T2340N-0606	10	3/8	3/8" -18		-0606	1.89	48	0.91	23	1.85	47	7/8	22	3/4	19
T2340N-0808	12	1/2	1/2" -14		-0808	2.13	54	1.14	29	2.09	53	1		7/8	22
T2340N-1212	19	3/4	3/4" -14		-1212	2.36	60	1.22	31	2.24	57	1.1/4	32	1.1/16	27
T2340N-1616	25	1	1" -11,5		-1616	2.68	68	1.46	37	2.83	72	1.1/2	38	1.5/16	

# ONE-PIECE COUPLINGS

## T2000 SERIES ONE-PIECE CRIMP COUPLINGS

**NPT**

**T2190**

NPT FEMALE  
FIXED

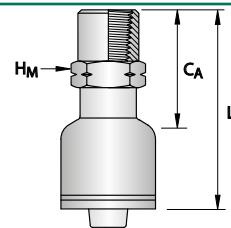

PART NO.	HOSE SIZE		THREAD SIZE	TUBE SIZE	DASH SIZE	DIMENSIONS				SPANNER				
	DN	inch	inch			L		CA		DL	HF		HM	
	DN	inch	inch			inch	mm	inch	mm		inch	mm	inch	mm
T2190-0402	6	1/4	1/8" -27		-0402	1.73	44	0.75	19				9/16	
T2190-0404	6	1/4	1/4" -18		-0404	2.01	51	1.02	26				3/4	19
T2190-0406	6	1/4	3/8" -18		-0406	2.13	54	1.10	28				7/8	22
T2190-0604	10	3/8	1/4" -18		-0604	2.01	51	1.02	26				3/4	19
T2190-0606	10	3/8	3/8" -18		-0606	2.13	54	1.14	29				7/8	22
T2190-0608	10	3/8	1/2" -14		-0608	2.28	58	1.30	33				1.1/16	27
T2190-0806	12	1/2	3/8" -18		-0806	2.09	53	1.10	28				7/8	22
T2190-0808	12	1/2	1/2" -14		-0808	2.28	58	1.34	34				1.1/16	27
T2190-1012	16	5/8	3/4" -14		-1012	2.64	67	1.46	37				1.3/8	35
T2190-1212	19	3/4	3/4" -14		-1212	2.64	67	1.46	37				1.3/8	35

**NPSM**

**T2020N**

NPSM FEMALE  
60° CONE

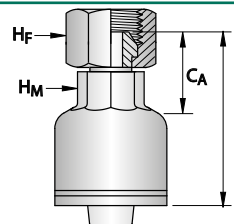

PART NO.	HOSE SIZE		THREAD SIZE	TUBE SIZE	DASH SIZE	DIMENSIONS				SPANNER				
	DN	inch	inch			L		CA		DL	HF		HM	
	DN	inch	inch			inch	mm	inch	mm		inch	mm	inch	mm
T2020N-0402	6	1/4	1/8" -27		-0402	1.85	47	0.83	21		9/16		1/2	
T2020N-0404	6	1/4	1/4" -18		-0404	1.85	47	0.87	22		11/16		1/2	
T2020N-0504	8	5/16	1/4" -18		-0504	1.85	47	0.87	22		11/16		9/16	
T2020N-0604	10	3/8	1/4" -18		-0604	1.85	47	0.87	22		11/16		9/16	
T2020N-0606	10	3/8	3/8" -18		-0606	1.93	49	0.94	24		7/8	22	5/8	16
T2020N-0608	10	3/8	1/2" -14		-0608	2.05	52	1.06	27		1		3/4	19
T2020N-0808	12	1/2	1/2" -14		-0808	2.01	51	1.02	26		1		3/4	19
T2020N-1212	19	3/4	3/4" -14		-1212	2.28	58	1.10	28		1.1/4	32	1	
T2020N-1616	25	1	1" -11,5		-1616	2.52	64	1.30	33		1.1/2	38	1.1/4	32
T2020N-2020	31	1.1/4	1.1/4" -11,5		-2020	3.58	91	1.61	41		1 7/8		1.3/4	
T2020N-2424	38	1.1/2	1.1/2" -11,5		-2424	3.82	97	1.77	45		2.1/4	57	2	50
T2020N-3232	51	2	2" -11,5		-3232	4.33	110	2.13	54		2.3/4	70	2.1/2	

## T2000 SERIES ONE-PIECE CRIMP COUPLINGS

### GREASE LINE

### T2861

GREASE LINE  
FIXED FEMALE

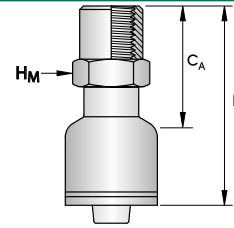

PART NO.	HOSE SIZE		THREAD SIZE	TUBE SIZE	DASH SIZE	DIMENSIONS				SPANNER			
	DN	inch	inch	inch		L		CA		DL	HF	HM	
						inch	mm	inch	mm			inch	mm
<b>T2861-0408</b>	6	1/4	1/2	5/16	-0408	1.89	48	0.91	23			11/16	

### JIC

### T2030

JIC 37° CONE MALE

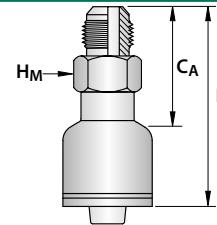

PART NO.	HOSE SIZE		THREAD SIZE	TUBE SIZE	DASH SIZE	DIMENSIONS				SPANNER			
	DN	inch	inch			L		CA		DL	HF	HM	
						inch	mm	inch	mm			inch	mm
<b>T2030-0407</b>	6	1/4	7/16" -20		-0407	2.17	55	1.14	29			1/2	
<b>T2030-0408</b>	6	1/4	1/2" -20		-0408	2.17	55	1.14	29			9/16	
<b>T2030-0409</b>	6	1/4	9/16" -18		-0409	2.17	55	1.18	30			5/8	16
<b>T2030-0412</b>	6	1/4	3/4" -16		-0412	2.28	58	1.26	32			13/16	
<b>T2030-0508</b>	8	5/16	1/2" -20		-0508	2.17	55	1.14	29			9/16	
<b>T2030-0509</b>	8	5/16	9/16" -18		-0509	2.17	55	1.18	30			5/8	16
<b>T2030-0609</b>	10	3/8	9/16" -18		-0609	2.24	57	1.26	32			5/8	16
<b>T2030-0612</b>	10	3/8	3/4" -16		-0612	2.32	59	1.38	35			3/4	19
<b>T2030-0614</b>	10	3/8	7/8" -14		-0614	2.44	62	1.46	37			7/8	22
<b>T2030-0812</b>	12	1/2	3/4" -16		-0812	2.40	61	1.46	37			3/4	19
<b>T2030-0814</b>	12	1/2	7/8" -14		-0814	2.52	64	1.54	39			15/16	24
<b>T2030-0817</b>	12	1/2	1.1/16" -12		-0817	2.64	67	1.65	42			1.1/8	
<b>T2030-1014</b>	16	5/8	7/8" -14		-1014	2.80	71	1.57	40			15/16	24
<b>T2030-1017</b>	16	5/8	1.1/16" -12		-1017	2.87	73	1.69	43			1.1/8	
<b>T2030-1214</b>	19	3/4	7/8" -14		-1214	2.80	71	1.61	41			1	
<b>T2030-1217</b>	19	3/4	1.1/16" -12		-1217	2.87	73	1.73	44			1.1/8	
<b>T2030-1219</b>	19	3/4	1.3/16" -12		-1219	2.91	74	1.77	45			1.1/4	32
<b>T2030-1221</b>	19	3/4	1.5/16" -12		-1221	2.95	75	1.77	45			1.3/8	35
<b>T2030-1621</b>	25	1	1.5/16" -12		-1621	3.03	77	1.85	47			1.3/8	35
<b>T2030-1626</b>	25	1	1.5/8" -12		-1626	3.11	79	1.89	48			1.3/4	
<b>T2030-2026</b>	31	1.1/4	1.5/8" -12		-2026	4.02	102	2.05	52			1.3/4	
<b>T2030-2430</b>	38	1.1/2	1.7/8" -12		-2430	4.29	109	2.24	57			2	50
<b>T2030-3240</b>	51	2	2.1/2" -12		-3240	5.12	130	2.87	73			2.1/2	

INTRODUCTION

INDEXES

ONE-PIECE  
COUPLINGS

PUSH-ON SUCTION &  
RETURN COUPLINGS

FIELD ATTACHABLE  
COUPLINGS

HYDRAULIC FITTINGS  
ACCESSORIES

# ONE-PIECE COUPLINGS

## T2000 SERIES ONE-PIECE CRIMP COUPLINGS

JIC

T2031

JIC  
37° CONE MALE  
METRIC HEX ONLY

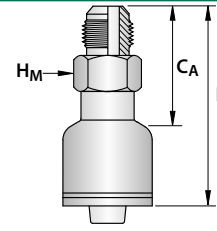

PART NO.	HOSE SIZE		THREAD SIZE	TUBE SIZE	DASH SIZE	DIMENSIONS				SPANNER			
	DN	inch	inch			L		C <sub>A</sub>		D <sub>L</sub>		H <sub>F</sub>	H <sub>M</sub>
						inch	mm	inch	mm				mm
T2031-0407	6	1/4	7/16" -20		-0407	2.17	55	1.14	29				12
T2031-0508	8	5/16	1/2" - 20		-0508	2.17	55	1.14	29				14
T2031-1221	19	3/4	1.5/16" -12		-1221	2.95	75	1.77	45				36
T2031-1621	25	1	1.5/16" -12		-1621	3.03	77	1.85	47				36

## T2000 SERIES ONE-PIECE CRIMP COUPLINGS

JSEAL™ / JIC

T2040

JSEAL™ / JIC  
FEMALE  
CONVEX SEAT

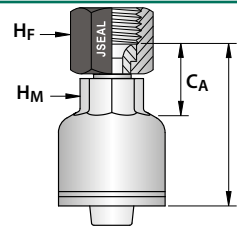

PART NO.	HOSE SIZE		THREAD SIZE	TUBE SIZE	DASH SIZE	DIMENSIONS				SPANNER					
	DN	inch	inch			L		C <sub>A</sub>		D <sub>L</sub>		H <sub>F</sub>		H <sub>M</sub>	
						inch	mm	inch	mm			inch	mm	inch	mm
T2040-0307	5	3/16	7/16" -20		-0307	1.61	41	0.87	22			9/16		1/2	
T2040-0406	6	1/4	3/8" -24		-0406	1.85	47	0.87	22			1/2		1/2	
T2040-0407	6	1/4	7/16" -20		-0407	1.77	45	0.79	20			9/16		1/2	
T2040-0408	6	1/4	1/2" -20		-0408	1.85	47	0.83	21			5/8	16	1/2	
T2040-0409	6	1/4	9/16" -18		-0409	1.89	48	0.91	23			11/16		1/2	
T2040-0412	6	1/4	3/4" -16		-0412	1.93	49	0.94	24			7/8	22	1/2	
T2040-0507	8	5/16	7/16" -20		-0507	1.85	47	0.87	22			9/16		9/16	
T2040-0508	8	5/16	1/2" -20		-0508	1.85	47	0.87	22			5/8	16	9/16	
T2040-0509	8	5/16	9/16" -18		-0509	1.89	48	0.87	22			11/16		9/16	
T2040-0512	8	5/16	3/4" -16		-0512	2.01	51	0.98	25			7/8	22	9/16	
T2040-0607	10	3/8	7/16" -20		-0607	1.85	47	0.87	22			9/16		5/8	16
T2040-0609	10	3/8	9/16" -18		-0609	1.85	47	0.87	22			11/16		5/8	16
T2040-0612	10	3/8	3/4" -16		-0612	1.97	50	0.98	25			7/8	22	5/8	16
T2040-0614	10	3/8	7/8" -14		-0614	2.05	52	1.06	27			1		5/8	16
T2040-0809	12	1/2	9/16" -18		-0809	2.68	68	1.69	43			11/16		3/4	19
T2040-0812	12	1/2	3/4" -16		-0812	1.97	50	0.98	25			7/8	22	3/4	19
T2040-0814	12	1/2	7/8" -14		-0814	2.05	52	1.06	27			1		3/4	19
T2040-0817	12	1/2	1.1/16" -12		-0817	2.20	56	1.22	31			1.1/4	32	3/4	19
T2040-1012	16	5/8	3/4" -16		-1012	2.20	56	0.98	25			7/8	22	7/8	22
T2040-1014	16	5/8	7/8" -14		-1014	2.24	57	1.06	27			1		7/8	22
T2040-1017	16	5/8	1.1/16" -12		-1017	2.40	61	1.18	30			1.1/4	32	7/8	22
T2040-1212	19	3/4	3/4" -16		-1212	2.36	60	1.18	28			7/8	22	1.1/16	27
T2040-1214	19	3/4	7/8" -14		-1214	2.48	63	1.34	32			1		1.1/16	27
T2040-1217	19	3/4	1.1/16" -12		-1217	2.36	60	1.14	29			1.1/4	32	15/16	24
T2040-1219	19	3/4	1.3/16" -12		-1219	2.40	61	1.22	31			1.3/8	35	1.1/8	
T2040-1221	19	3/4	1.5/16" -12		-1221	2.68	68	1.50	36			1.1/2	38	1.1/16	27
T2040-1617	25	1	1.1/16" -12		-1617	2.56	65	1.34	37			1.1/4	32	1.1/4	32
T2040-1621	25	1	1.5/16" -12		-1621	2.60	66	1.38	33			1.1/2	38	1.1/4	32
T2040-1626	25	1	1.5/8" -12		-1626	2.83	72	1.61	38			2	50	1.1/4	32
T2040-1630	25	1	1.7/8" -12		-1630	3.07	78	1.85	47			2.1/4	57	1.1/4	32
T2040-2026	31	1.1/4	1.5/8" -12		-2026	3.62	92	1.69	43			2	50	1.5/8	41
T2040-2030	31	1.1/4	1.7/8" -12		-2030	3.98	101	2.05	52			2.1/4	57	1.5/8	41
T2040-2430	38	1.1/2	1.7/8" -12		-2430	4.13	105	2.09	53			2.1/4	57	2	50
T2040-3240	51	2	2.1/2" -12		-3240	4.65	118	2.44	62			2.7/8	73	2.1/2	
T2040-4048	63	2.1/2	3" -12		-4048	4.57	116	1.54	39			3.1/2	90		

INTRODUCTION

INDEXES

ONE-PIECE  
COUPLINGS

PUSH-ON SUCTION &  
RETURN COUPLINGS

FIELD ATTACHABLE  
COUPLINGS

HYDRAULIC FITTINGS  
ACCESSORIES

# ONE-PIECE COUPLINGS

## T2000 SERIES ONE-PIECE CRIMP COUPLINGS

JSEAL™ / JIC

T2041

JSEAL™ / JIC  
FEMALE CONVEX SEAT  
METRIC NUT ONLY

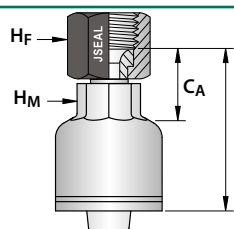

PART NO.	HOSE SIZE		THREAD SIZE	TUBE SIZE	DASH SIZE	DIMENSIONS						SPANNER			
	DN	inch	inch			L		C <sub>A</sub>		D <sub>L</sub>		H <sub>F</sub>		H <sub>M</sub>	
						inch	mm	inch	mm			inch	mm	inch	mm
T2041-0307	5	3/16	7/16" -20		-0307	1.61	41	0.87	22				14	1/2	
T2041-0407	6	1/4	7/16" -20		-0407	1.77	45	0.79	20				14	1/2	
T2041-0409	6	1/4	9/16" -18		-0409	1.89	48	0.91	23			3/4	19	1/2	
T2041-0507	8	5/16	7/16" -20		-0507	1.85	47	0.87	22				14	9/16	
T2041-0509	8	5/16	9/16" -18		-0509	1.89	48	0.87	22			3/4	19	9/16	
T2041-0607	10	3/8	7/16" -20		-0607	1.85	47	0.87	22				14	5/8	16
T2041-0609	10	3/8	9/16" -18		-0609	1.85	47	0.87	22			3/4	19	5/8	16
T2041-0809	12	1/2	9/16" -18		-0809	2.68	68	1.69	43			3/4	19	3/4	19

JSEAL™ / JIC

T2080

JSEAL™ / JIC  
FEMALE CONVEX SEAT  
45° ELBOW

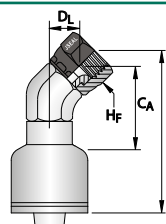

PART NO.	HOSE SIZE		THREAD SIZE	TUBE SIZE	DASH SIZE	DIMENSIONS						SPANNER			
	DN	inch	inch			L		C <sub>A</sub>		D <sub>L</sub>		H <sub>F</sub>		H <sub>M</sub>	
						inch	mm	inch	mm	inch	mm	inch	mm	inch	mm
T2080-0406	6	1/4	3/8" -24		-0406	2.09	53	1.10	28	0.51	13	1/2		9/16	
T2080-0407	6	1/4	7/16" -20		-0407	2.09	53	1.10	28	0.51	13	9/16		9/16	
T2080-0408	6	1/4	1/2" -20		-0408	2.09	53	1.10	28	0.51	13	5/8	16	9/16	
T2080-0409	6	1/4	9/16" -18		-0409	2.01	51	1.02	26	0.47	12	11/16		9/16	
T2080-0609	10	3/8	9/16" -18		-0609	2.20	56	1.26	32	0.55	14	11/16		3/4	19
T2080-0612	10	3/8	3/4" -16		-0612	1.65	42	0.67	17	0.59	15	7/8	22	3/4	19
T2080-0812	12	1/2	3/4" -16		-0812	1.81	46	0.83	21	0.63	16	7/8	22	7/8	22
T2080-0814	12	1/2	7/8" -14		-0814	2.48	63	1.50	38	0.67	17	1		7/8	22
T2080-1217	19	3/4	1.1/16" -12		-1217	2.13	54	0.98	25	0.67	17	1.1/4	32	1.1/16	27
T2080-1621	25	1	1.5/16" -12		-1621	2.32	59	1.10	28	0.83	21	1.1/2	38	1.5/16	

## T2000 SERIES ONE-PIECE CRIMP COUPLINGS

### JSEAL™ / JIC

### T2081

JSEAL™ / JIC  
FEMALE  
CONVEX SEAT  
45° ELBOW  
METRIC NUT ONLY

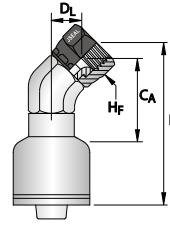

PART NO.	HOSE SIZE		THREAD SIZE	TUBE SIZE	DASH SIZE	DIMENSIONS						SPANNER			
	DN	inch	inch			L		C <sub>A</sub>		D <sub>L</sub>		H <sub>F</sub>		H <sub>M</sub>	
						inch	mm	inch	mm	inch	mm	inch	mm	inch	mm
T2081-0407	6	1/4	7/16" -20		-0407	2.09	53	1.10	28	0.51	13		14	9/16	
T2081-0409	6	1/4	9/16" -18		-0409	2.01	51	1.02	26	0.47	12	3/4	19	9/16	
T2081-0609	10	3/8	9/16" -18		-0609	2.20	56	1.26	32	0.55	14	3/4	19	3/4	19

### JSEAL™ / JIC

### T2070

JSEAL™ / JIC  
FEMALE  
CONVEX SEAT  
90° ELBOW

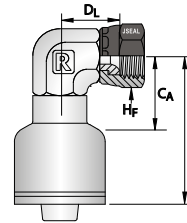

PART NO.	HOSE SIZE		THREAD SIZE	TUBE SIZE	DASH SIZE	DIMENSIONS						SPANNER			
	DN	inch	inch			L		C <sub>A</sub>		D <sub>L</sub>		H <sub>F</sub>		H <sub>M</sub>	
						inch	mm	inch	mm	inch	mm	inch	mm	inch	mm
T2070-0307	5	3/16	7/16" -20		-0307	1.61	41	0.87	22	0.71	18	9/16		9/16	
T2070-0406	6	1/4	3/8" -24		-0406	1.85	47	0.87	22	0.67	17	1/2		9/16	
T2070-0407	6	1/4	7/16" -20		-0407	1.85	47	0.83	21	0.67	17	9/16		9/16	
T2070-0408	6	1/4	1/2" -20		-0408	1.85	47	0.87	22	0.67	17	5/8	16	9/16	
T2070-0409	6	1/4	9/16" -18		-0409	1.85	47	0.83	21	0.87	22	11/16		9/16	
T2070-0609	10	3/8	9/16" -18		-0609	1.89	48	0.91	23	0.91	23	11/16		3/4	19
T2070-0612	10	3/8	3/4" -16		-0612	1.89	48	0.91	23	0.94	24	7/8	22	3/4	19
T2070-0812	12	1/2	3/4" -16		-0812	2.13	54	1.14	29	1.06	27	7/8	22	7/8	22
T2070-0814	12	1/2	7/8" -14		-0814	2.13	54	1.14	29	1.22	31	1		7/8	22
T2070-0817	12	1/2	1.1/16" -12		-0817	2.13	54	1.14	29	1.26	32	1.1/4	32	1.1/16	27
T2070-1217	19	3/4	1.1/16" -12		-1217	2.36	60	1.22	31	1.26	32	1.1/4	32	1.1/16	27
T2070-1621	25	1	1.5/16" -12		-1621	2.48	63	1.26	32	1.50	38	1.1/2	38	1.5/16	

INTRODUCTION

INDEXES

ONE-PIECE  
COUPLINGS

PUSH-ON SUCTION &  
RETURN COUPLINGS

FIELD ATTACHABLE  
COUPLINGS

HYDRAULIC FITTINGS  
ACCESSORIES

# ONE-PIECE COUPLINGS

## T2000 SERIES ONE-PIECE CRIMP COUPLINGS

**JSEAL™ / JIC**

**T2071**

JSEAL™ / JIC FEMALE  
CONVEX SEAT  
90° ELBOW  
METRIC NUT ONLY

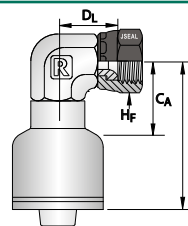

PART NO.	HOSE SIZE		THREAD SIZE	TUBE SIZE	DASH SIZE	DIMENSIONS						SPANNER			
	DN	inch	inch			L		C <sub>A</sub>		D <sub>L</sub>		H <sub>F</sub>		H <sub>M</sub>	
						inch	mm	inch	mm	inch	mm	inch	mm	inch	mm
T2071-0307	5	3/16	7/16" -20		-0307	1.61	41	0.87	22	0.71	18		14	9/16	
T2071-0407	6	1/4	7/16" -20		-0407	1.85	47	0.83	21	0.67	17		14	9/16	
T2071-0409	6	1/4	9/16" -18		-0409	1.85	47	0.83	21	0.87	22	3/4	19	9/16	
T2071-0609	10	3/8	9/16" -18		-0609	1.89	48	0.91	23	0.91	23	3/4	19	3/4	19

**JSEAL™ / JIC**

**T2250**

JSEAL™ / JIC  
FEMALE CONVEX SEAT  
45° TUBE BEND

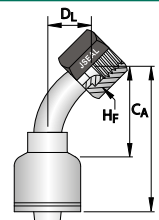

PART NO.	HOSE SIZE		THREAD SIZE	TUBE SIZE	DASH SIZE	DIMENSIONS						SPANNER			
	DN	inch	inch			L		C <sub>A</sub>		D <sub>L</sub>		H <sub>F</sub>		H <sub>M</sub>	
						inch	mm	inch	mm	inch	mm	inch	mm		
T2250-0407	6	1/4	7/16" -20		-0407	2.56	65	1.57	40	0.59	15	9/16			
T2250-0408	6	1/4	1/2" - 20		-0408	2.28	58	1.30	33	0.59	15	5/8	16		
T2250-0409	6	1/4	9/16" -18		-0409	2.28	58	1.30	33	0.59	15	11/16			
T2250-0509	8	5/16	9/16" -18		-0509	2.60	66	1.57	40	0.63	16	11/16			
T2250-0609	10	3/8	9/16" -18		-0609	2.48	63	1.50	38	0.55	14	11/16			
T2250-0612	10	3/8	3/4" -16		-0612	2.52	64	1.54	39	0.67	17	7/8	22		
T2250-0812	12	1/2	3/4" -16		-0812	2.80	71	1.81	46	0.83	21	7/8	22		
T2250-0814	12	1/2	7/8" -14		-0814	2.83	72	1.85	47	0.87	22	1			
T2250-0817	12	1/2	1.1/16" -12		-0817	2.83	72	1.85	47	0.83	21	1.1/4	32		
T2250-1014	16	5/8	7/8" -14		-1014	3.66	93	2.44	62	0.94	24	1			
T2250-1017	16	5/8	1.1/16" -12		-1017	3.35	85	2.13	54	0.94	24	1.1/4	32		
T2250-1214	19	3/4	7/8" -14		-1214	3.82	95	2.64	65	0.94	24	1			
T2250-1217	19	3/4	1.1/16" -12		-1217	4.25	108	3.03	77	1.10	28	1.1/4	32		
T2250-1219	19	3/4	1.3/16" -12		-1219	3.66	93	2.52	64	0.94	24	1.3/8	35		
T2250-1221	19	3/4	1.5/16" -12		-1221	4.69	117	3.50	87	1.50	38	1.1/2	38		
T2250-1621	25	1	1.5/16" -12		-1621	4.53	115	3.31	82	1.38	35	1.1/2	38		
T2250-1626	25	1	1.5/8" -12		-1626	4.69	119	3.50	86	1.54	39	2	50		
T2250-2026	31	1.1/4	1.5/8" -12		-2026	5.87	149	3.94	100	1.54	39	2	50		
T2250-2030	31	1.1/4	1.7/8" -12		-2030	5.98	152	4.06	103	1.65	42	2.1/4	57		
T2250-2430	38	1.1/2	1.7/8" -12		-2430	7.09	180	5.04	128	1.97	50	2.1/4	57		
T2250-3240	51	2	2.1/2" -12		-3240	8.66	220	6.46	164	2.48	63	2.7/8	73		

## T2000 SERIES ONE-PIECE CRIMP COUPLINGS

### JSEAL™ / JIC

### T2251

JSEAL™ / JIC FEMALE  
CONVEX SEAT  
45° TUBE BEND  
METRIC NUT ONLY

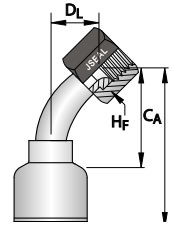

PART NO.	HOSE SIZE		THREAD SIZE	TUBE SIZE	DASH SIZE	DIMENSIONS						SPANNER		
	DN	inch	inch			L		C <sub>A</sub>		D <sub>L</sub>		H <sub>F</sub>		H <sub>M</sub>
T2251-0407	6	1/4	7/16" -20		-0407	2.56	65	1.57	40	0.59	15		14	
T2251-0409	6	1/4	9/16" -18		-0409	2.28	58	1.30	33	0.59	15	3/4	19	
T2251-0509	8	5/16	9/16" -18		-0509	2.60	66	1.57	40	0.63	16	3/4	19	
T2251-0609	10	3/8	9/16" -18		-0609	2.48	63	1.50	38	0.55	14	3/4	19	

### JSEAL™ / JIC

### T2243

JSEAL™ / JIC  
FEMALE CONVEX SEAT  
90° SHORT TUBE BEND

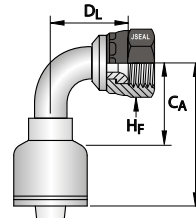

PART NO.	HOSE SIZE		THREAD SIZE	TUBE SIZE	DASH SIZE	DIMENSIONS						SPANNER		
	DN	inch	inch			L		C <sub>A</sub>		D <sub>L</sub>		H <sub>F</sub>		H <sub>M</sub>
T2243-0407	6	1/4	7/16" -20		-0407	2.44	62	1.46	37	0.83	21	9/16		
T2243-0409	6	1/4	9/16" -18		-0409	2.05	52	1.06	27	0.87	22	11/16		
T2243-0609	10	3/8	9/16" -18		-0609	2.20	56	1.22	31	0.91	23	11/16		
T2243-0812	12	1/2	3/4" -16		-0812	2.68	68	1.69	43	1.14	29	7/8	22	
T2243-1014	16	5/8	7/8" -14		-1014	3.31	84	2.09	53	1.34	34	1		
T2243-1214	19	3/4	7/8" -14		-1214	3.27	81	2.09	51	1.34	34	1		
T2243-1217	19	3/4	1.1/16" -12		-1217	3.78	94	2.60	64	1.85	47	1.1/4	32	
T2243-1617	25	1	1.1/16" -12		-1617	3.39	86	2.17	58	1.85	47	1.1/4	32	
T2243-1621	25	1	1.5/16" -12		-1621	4.41	112	3.19	71	2.28	58	1.1/2	38	

### JSEAL™ / JIC

### T2244

JSEAL™ / JIC FEMALE  
CONVEX SEAT  
90° SHORT TUBE BEND  
METRIC NUT ONLY

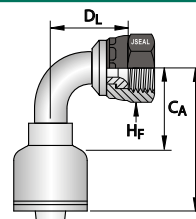

PART NO.	HOSE SIZE		THREAD SIZE	TUBE SIZE	DASH SIZE	DIMENSIONS						SPANNER		
	DN	inch	inch			L		C <sub>A</sub>		D <sub>L</sub>		H <sub>F</sub>		H <sub>M</sub>
T2244-0407	6	1/4	7/16" -20		-0407	2.44	62	1.46	37	0.83	21		14	
T2244-0409	6	1/4	9/16" -18		-0409	2.05	52	1.06	27	0.87	22	3/4	19	
T2244-0609	10	3/8	9/16" -18		-0609	2.20	56	1.22	31	0.91	23	3/4	19	

# ONE-PIECE COUPLINGS

## T2000 SERIES ONE-PIECE CRIMP COUPLINGS

JSEAL™ / JIC

T2240

JSEAL™ / JIC  
FEMALE CONVEX SEAT  
90° TUBE BEND

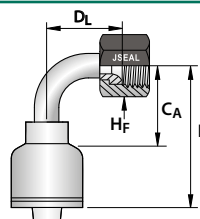

PART NO.	HOSE SIZE		THREAD SIZE	TUBE SIZE	DASH SIZE	DIMENSIONS						SPANNER		
	DN	inch	inch			L		CA		DL		HF		HM
						inch	mm	inch	mm	inch	mm	inch	mm	
T2240-0407	6	1/4	7/16" -20		-0407	2.52	64	1.54	39	1.26	32	9/16		
T2240-0408	6	1/4	1/2" - 20		-0408	2.24	57	1.26	32	1.26	32	5/8	16	
T2240-0409	6	1/4	9/16" -18		-0409	2.28	58	1.30	33	1.50	38	11/16		
T2240-0412	6	1/4	3/4" -16		-0412	2.01	51	1.02	26	1.50	38	7/8	22	
T2240-0509	8	5/16	9/16" -18		-0509	2.32	59	1.34	34	1.18	30	11/16		
T2240-0512	8	5/16	3/4" -16		-0512	2.36	60	1.38	35	1.61	41	7/8	22	
T2240-0609	10	3/8	9/16" -18		-0609	2.32	59	1.34	34	1.02	26	11/16		
T2240-0612	10	3/8	3/4" -16		-0612	2.36	60	1.38	35	1.18	30	7/8	22	
T2240-0614	10	3/8	7/8" -14		-0614	2.36	60	1.38	35	1.61	41	1		
T2240-0812	12	1/2	3/4" -16		-0812	2.60	66	1.61	41	1.50	38	7/8	22	
T2240-0814	12	1/2	7/8" -14		-0814	2.60	66	1.61	41	1.61	41	1		
T2240-0817	12	1/2	1.1/16" -12		-0817	2.60	66	1.61	41	1.77	45	1.1/4	32	
T2240-1012	16	5/8	3/4" -16		-1012	3.15	80	1.97	50	1.61	41	7/8	22	
T2240-1014	16	5/8	7/8" -14		-1014	2.99	76	1.77	45	1.85	47	1		
T2240-1017	16	5/8	1.1/16" -12		-1017	2.99	76	1.77	45	1.89	48	1.1/4	32	
T2240-1214	19	3/4	7/8" -14		-1214	3.35	83	2.17	53	1.89	48	1		
T2240-1217	19	3/4	1.1/16" -12		-1217	3.50	89	2.24	57	2.24	57	1.1/4	32	
T2240-1219	19	3/4	1.3/16" -12		-1219	3.35	85	2.17	55	2.28	58	1.3/8	35	
T2240-1221	19	3/4	1.5/16" -12		-1221	3.50	87	2.32	57	2.80	71	1.1/2	38	
T2240-1617	25	1	1.1/16" -12		-1617	3.39	86	2.17	58	2.32	59	1.1/4	32	
T2240-1621	25	1	1.5/16" -12		-1621	3.86	98	2.68	74	2.83	72	1.1/2	38	
T2240-1626	25	1	1.5/8" -12		-1626	3.90	99	2.68	74	3.07	78	2	50	
T2240-2026	31	1.1/4	1.5/8" -12		-2026	5.87	149	3.94	100	3.19	81	2	50	
T2240-2430	38	1.1/2	1.7/8" -12		-2430	6.22	158	4.17	106	4.17	106	2.1/4	57	
T2240-3240	51	2	2.1/2" -12		-3240	8.03	204	5.83	148	5.20	132	2.7/8	73	

JSEAL™ / JIC

T2241

JSEAL™ / JIC FEMALE  
CONVEX SEAT  
90° TUBE BEND  
METRIC NUT ONLY

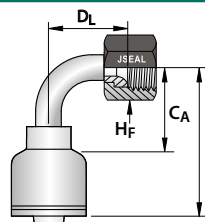

PART NO.	HOSE SIZE		THREAD SIZE	TUBE SIZE	DASH SIZE	DIMENSIONS						SPANNER		
	DN	inch	inch			L		CA		DL		HF		HM
						inch	mm	inch	mm	inch	mm	inch	mm	
T2241-0407	6	1/4	7/16" -20		-0407	2.52	64	1.54	39	1.26	32		14	
T2241-0409	6	1/4	9/16" -18		-0409	2.28	58	1.30	33	1.50	38	3/4	19	
T2241-0509	8	5/16	9/16" -18		-0509	2.32	59	1.34	34	1.18	30	3/4	19	
T2241-0609	10	3/8	9/16" -18		-0609	2.32	59	1.34	34	1.02	26	3/4	19	

## T2000 SERIES ONE-PIECE CRIMP COUPLINGS

### JSEAL™ / JIC

### T2280

JSEAL™ / JIC  
FEMALE CONVEX SEAT  
90° LONG TUBE BEND

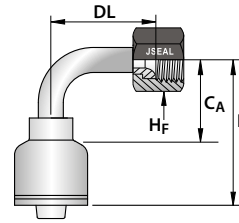

PART NO.	HOSE SIZE		THREAD SIZE	TUBE SIZE	DASH SIZE	DIMENSIONS						SPANNER		
	DN	inch	inch			L		C <sub>A</sub>		D <sub>L</sub>		H <sub>F</sub>		H <sub>M</sub>
						inch	mm	inch	mm	inch	mm	inch	mm	
T2280-0407	6	1/4	7/16" -20		-0407	2.68	68	1.69	43	1.85	47	9/16		
T2280-0409	6	1/4	9/16" -18		-0409	2.83	72	1.85	47	2.13	54	11/16		
T2280-0609	10	3/8	9/16" -18		-0609	3.03	77	2.05	52	2.17	55	11/16		
T2280-0612	10	3/8	3/4" -16		-0612	3.03	77	2.05	52	2.52	64	7/8	22	
T2280-0812	12	1/2	3/4" -16		-0812	2.99	76	2.01	51	2.36	60	7/8	22	
T2280-0814	12	1/2	7/8" -14		-0814	3.15	80	2.17	55	2.76	70	1		
T2280-1014	16	5/8	7/8" -14		-1014	3.23	82	2.01	51	2.76	70	1		
T2280-1017	16	5/8	1.1/16" -12		-1017	3.23	82	2.01	51	3.78	96	1.1/4	32	
T2280-1217	19	3/4	1.1/16" -12		-1217	3.50	89	2.24	57	3.78	96	1.1/4	32	
T2280-1621	25	1	1.5/16" -12		-1621	4.17	106	2.95	74	4.49	114	1.1/2	38	
T2280-2026	31	1.1/4	1.5/8" -12		-2026	5.87	149	3.94	100	5.08	129	2	50	
T2280-2430	38	1.1/2	1.7/8" -12		-2430	6.22	158	4.17	106	5.55	141	2.1/4	57	
T2280-3240	51	2	2.1/2" -12		-3240	8.03	204	5.83	148	8.74	222	2.7/8	73	

### JSEAL™ / JIC

### T2281

JSEAL™ / JIC FEMALE  
CONVEX SEAT  
90° LONG TUBE BEND  
METRIC NUT ONLY

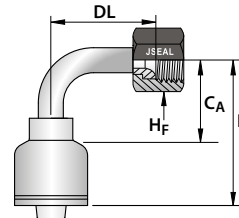

PART NO.	HOSE SIZE		THREAD SIZE	TUBE SIZE	DASH SIZE	DIMENSIONS						SPANNER		
	DN	inch	inch			L		C <sub>A</sub>		D <sub>L</sub>		H <sub>F</sub>		H <sub>M</sub>
						inch	mm	inch	mm	inch	mm	inch	mm	
T2281-0407	6	1/4	7/16" -20		-0407	2.68	68	1.69	43	1.85	47	14		
T2281-0409	6	1/4	9/16" -18		-0409	2.83	72	1.85	47	2.13	54	3/4	19	
T2281-0609	10	3/8	9/16" -18		-0609	3.03	77	2.05	52	2.17	55	3/4	19	

# ONE-PIECE COUPLINGS

## T2000 SERIES ONE-PIECE CRIMP COUPLINGS

### JIS - BSPP

### T2220

JAPANESE INDUSTRIAL STANDARD (JIS)  
BSPP MALE  
60° CONVEX SEAT (JIS)

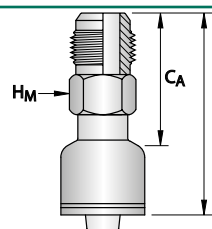

PART NO.	HOSE SIZE		THREAD SIZE	TUBE SIZE	DASH SIZE	DIMENSIONS				SPANNER					
	DN	inch	inch			L		CA		DL		HF		HM	
	DN	inch	inch			inch	mm	inch	mm			inch	mm	inch	mm
T2220-0404	6	1/4	1/4" -19		-0404	2.20	56	1.22	31					11/16	
T2220-0606	10	3/8	3/8" -19		-0606	2.36	60	1.38	35					3/4	19
T2220-0808	12	1/2	1/2" -14		-0808	2.52	64	1.54	39					1	

### JIC - BSPP

### T2122

JAPANESE INDUSTRIAL STANDARD (JIS)  
BSPP FEMALE  
60° CONCAVE SEAT (JIS)

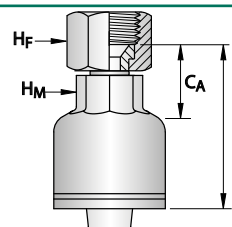

PART NO.	HOSE SIZE		THREAD SIZE	TUBE SIZE	DASH SIZE	DIMENSIONS				SPANNER					
	DN	inch	inch			L		CA		DL		HF		HM	
	DN	inch	inch			inch	mm	inch	mm			inch	mm	inch	mm
T2122-0404	6	1/4	1/4" -19		-0404	1.93	49	0.94	24			3/4	19		14
T2122-0606	10	3/8	3/8" -19		-0606	1.97	50	0.98	25			7/8	22		17
T2122-0608	10	3/8	1/2" -14		-0608	2.01	51	1.06	27			1.1/16	27	3/4	19
T2122-0808	12	1/2	1/2" -14		-0808	2.05	52	1.06	27			1.1/16	27	3/4	19
T2122-1012	16	5/8	3/4" -16		-1012	2.28	58	1.10	28				36	1.1/16	27
T2122-1212	19	3/4	3/4" -16		-1212	2.36	60	1.18	30				36	1.1/16	27
T2122-1616	25	1	1" -11		-1616	2.48	63	1.26	32			1.5/8	41		36

## T2000 SERIES ONE-PIECE CRIMP COUPLINGS

JIS

T2680

JAPANESE INDUSTRIAL STANDARD (JIS)  
METRIC FEMALE  
60° CONCAVE SEAT (JIS)

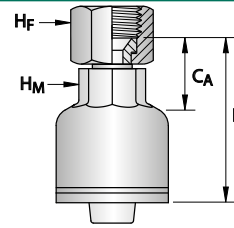

PART NO.	HOSE SIZE		THREAD SIZE	TUBE SIZE	DASH SIZE	DIMENSIONS						SPANNER			
	DN	inch				mm	L		C <sub>A</sub>		D <sub>L</sub>		H <sub>F</sub>		H <sub>M</sub>
						inch	mm	inch	mm			inch	mm	inch	mm
T2680-0414	6	1/4	M 14X1,5		-0414	1.77	45	0.79	20			3/4	19		14
T2680-0418	6	1/4	M 18X1,5		-0418	1.89	48	0.91	23			15/16	24		17
T2680-0516	8	5/16	M 16X1,5		-0516	1.89	48	0.91	23					5/8	16
T2680-0616	10	3/8	M 16X1,5		-0616	1.85	47	0.87	22				21		
T2680-0618	10	3/8	M 18X1,5		-0618	1.85	47	0.87	22			15/16	24		17
T2680-0620	10	3/8	M 20X1,5		-0620	2.01	51	1.02	26			1.1/16	27	3/4	19
T2680-0622	10	3/8	M 22X1,5		-0622	2.05	52	1.06	27			1.1/16	27	7/8	22
T2680-0822	12	1/2	M 22X1,5		-0822	2.09	53	1.10	28			1.1/16	27	7/8	22
T2680-0824	12	1/2	M 24X1,5		-0824	2.09	53	1.10	28			1.1/4	32	7/8	22
T2680-1024	16	5/8	M 24X1,5		-1024	2.20	56	1.02	26			1.1/4	32	7/8	22
T2680-1030	16	5/8	M 30X1,5		-1030	2.48	63	1.30	33				36	1.1/4	32
T2680-1224	19	3/4	M 24X1,5		-1224	2.24	57	1.06	27			1.1/4	32	1.1/16	27
T2680-1230	19	3/4	M 30X1,5		-1230	2.52	64	1.34	34				36	1.1/4	32
T2680-1233	19	3/4	M 33X1,5		-1233	2.36	60	1.18	30			1.5/8	41	1.1/4	32
T2680-1633	25	1	M 33X1,5		-1633	2.40	61	1.18	30			1.5/8	41	1.1/4	32
T2680-2036	31	1.1/4	M 36X1,5		-2036	3.43	87	1.46	37				46	1.1/2	38
T2680-2042	31	1.1/4	M 42X1,5		-2042	3.50	89	1.54	39			2	50	1.5/8	41

JIS

T2682

METRIC FEMALE  
60° CONCAVE SEAT (JIS) 45° BEND

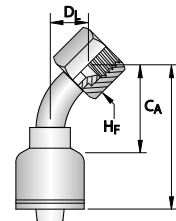

PART NO.	HOSE SIZE		THREAD SIZE	TUBE SIZE	DASH SIZE	DIMENSIONS						SPANNER			
	DN	inch				mm	L		C <sub>A</sub>		D <sub>L</sub>		H <sub>F</sub>		H <sub>M</sub>
						inch	mm	inch	mm	inch	mm	inch	mm		
T2682-0414	6	1/4	M 14X1,5		-0414	2.28	58	1.30	33	0.59	15	3/4	19		
T2682-0618	10	3/8	M 18X1,5		-0618	2.52	64	1.54	39	0.75	19	15/16	24		
T2682-0822	12	1/2	M 22X1,5		-0822	2.87	73	1.89	48	0.87	22	1.1/16	27		
T2682-1024	16	5/8	M 24X1,5		-1024	3.27	83	2.09	53	0.94	24	1.1/4	32		
T2682-1230	19	3/4	M 30X1,5		-1230	3.78	96	2.64	67	1.10	28		36		
T2682-1633	25	1	M 33X1,5		-1633	5.55	141	3.27	83	1.34	34		41		

# ONE-PIECE COUPLINGS

## T2000 SERIES ONE-PIECE CRIMP COUPLINGS

JIS

T2683

JAPANESE INDUSTRIAL STANDARD (JIS)  
METRIC FEMALE  
60° CONCAVE SEAT (JIS) 90° BEND

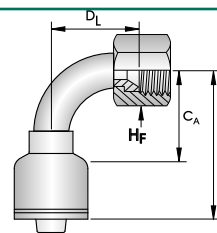

PART NO.	HOSE SIZE		THREAD SIZE	TUBE SIZE	DASH SIZE	DIMENSIONS						SPANNER		
	DN	inch	mm			L		C <sub>A</sub>		D <sub>L</sub>		H <sub>F</sub>		H <sub>M</sub>
						inch	mm	inch	mm	inch	mm	inch	mm	
T2683-0414	6	1/4	M 14X1,5		-0414	2.05	52	1.06	27	1.18	30	3/4	19	
T2683-0618	10	3/8	M 18X1,5		-0618	2.36	60	1.38	35	1.30	33	15/16	24	
T2683-0822	12	1/2	M 22X1,5		-0822	2.52	64	1.54	39	1.65	42	1.1/16	27	
T2683-1024	16	5/8	M 24X1,5		-1024	2.95	75	1.77	45	1.89	48	1.1/4	32	
T2683-1230	19	3/4	M 30X1,5		-1230	3.35	85	2.20	56	2.20	56		36	
T2683-1633	25	1	M 33X1,5		-1633	4.06	103	2.83	72	2.83	72		41	

JOINER

T2900

JOINER

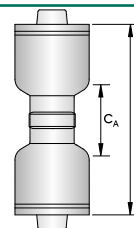

PART NO.	HOSE SIZE		THREAD SIZE	TUBE SIZE	DASH SIZE	DIMENSIONS						SPANNER	
	DN	inch		inch		L		C <sub>A</sub>		D <sub>L</sub>	H <sub>F</sub>	H <sub>M</sub>	
						inch	mm	inch	mm				
T2900-0404	6	1/4		1/4	-0404	2.52	64	0.51	13				
T2900-0505	8	5/16		5/16	-0505	2.52	64	0.51	13				
T2900-0606	10	3/8		3/8	-0606	2.52	64	0.59	15				
T2900-0808	12	1/2		1/2	-0808	2.56	65	0.59	15				
T2900-1010	16	5/8		5/8	-1010	2.95	75	0.55	14				
T2900-1212	19	3/4		3/4	-1212	2.95	75	0.63	16				
T2900-1616	25	1		1	-1616	3.43	87	0.98	25				
T2900-2020	31	1.1/4		1.1/4	-2020	4.88	124	0.94	24				
T2900-2424	38	1.1/2		1.1/2	-2424	5.08	129	1.02	26				
T2900-3232	51	2		2	-3232	5.47	139	1.06	27				
T2900-4040	63	2.1/2		2.1/2	-4040	7.05	179	1.02	26				
T2900-4848	76	3		3	-4848	7.05	179	1.02	26				

## T2000 SERIES ONE-PIECE CRIMP COUPLINGS

**METRIC - DKL**

**T2650**

DKL MALE  
24° SEAT

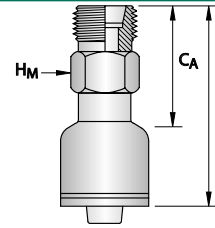

PART NO.	HOSE SIZE		THREAD SIZE	TUBE SIZE	DASH SIZE	DIMENSIONS				SPANNER				
	DN	inch	mm	mm		L		C <sub>A</sub>		D <sub>L</sub>		H <sub>F</sub>	H <sub>M</sub>	
						inch	mm	inch	mm				inch	mm
T2650-0412	6	1/4	M 12X1,5	6	-0412	2.01	51	0.98	25					14
T2650-0414	6	1/4	M 14X1,5	8	-0414	2.01	51	0.98	25					14
T2650-0416	6	1/4	M 16X1,5	10	-0416	2.05	52	1.02	26					17
T2650-0418	6	1/4	M 18X1,5	12	-0418	2.05	52	1.02	26				3/4	19
T2650-0516	8	5/16	M 16X1,5	10	-0516	2.13	54	1.14	29					17
T2650-0518	8	5/16	M 18X1,5	12	-0518	2.05	52	1.02	26				3/4	19
T2650-0616	10	3/8	M 16X1,5	10	-0616	2.13	54	1.14	29					17
T2650-0618	10	3/8	M 18X1,5	12	-0618	2.13	54	1.14	29				3/4	19
T2650-0622	10	3/8	M 22X1,5	15	-0622	2.05	52	1.06	27				15/16	24
T2650-0818	12	1/2	M 18X1,5	12	-0818	2.13	54	1.18	30				3/4	19
T2650-0822	12	1/2	M 22X1,5	15	-0822	2.24	57	1.26	32				7/8	22
T2650-0826	12	1/2	M 26X1,5	18	-0826	2.24	57	1.26	32				1.3/16	30
T2650-1026	16	5/8	M 26X1,5	18	-1026	2.32	59	1.14	29				1.3/16	30
T2650-1030	16	5/8	M 30X2	22	-1030	2.40	61	1.22	31				1.1/4	32
T2650-1226	19	3/4	M 26X1,5	18	-1226	2.32	59	1.18	30				1.3/16	30
T2650-1230	19	3/4	M 30X2	22	-1230	2.40	61	1.26	32				1.1/4	32
T2650-1636	25	1	M 36X2	28	-1636	2.68	68	1.50	38				1.5/8	41
T2650-2045	31	1.1/4	M 45X2	35	-2045	3.66	93	1.69	43					46
T2650-2452	38	1.1/2	M 52X2	42	-2452	3.90	99	1.89	48				2.3/16	55

INTRODUCTION

INDEXES

ONE-PIECE  
COUPLINGS

PUSH-ON SUCTION &  
RETURN COUPLINGS

FIELD ATTACHABLE  
COUPLINGS

HYDRAULIC FITTINGS  
ACCESSORIES

# ONE-PIECE COUPLINGS

## T2000 SERIES ONE-PIECE CRIMP COUPLINGS

### METRIC - DKL

### T2600

DKL FEMALE

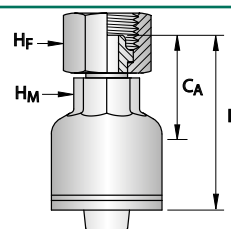

PART NO.	HOSE SIZE		THREAD SIZE	TUBE SIZE	DASH SIZE	DIMENSIONS						SPANNER		
	DN	inch				mm	mm	L		CA		DL		HF
						inch	mm	inch	mm	inch	mm	inch	mm	
T2600-0412	6	1/4	M 12X1,5	6	-0412	1.85	47	0.83	21				14	
T2600-0414	6	1/4	M 14X1,5	8	-0414	1.85	47	0.87	22				17	
T2600-0416	6	1/4	M 16X1,5	10	-0416	1.89	48	0.91	23			3/4	19	
T2600-0516	8	5/16	M 16X1,5	10	-0516	1.89	48	0.91	23			3/4	19	
T2600-0518	8	5/16	M 18X1,5	12	-0518	1.89	48	0.91	23			7/8	22	
T2600-0614	10	3/8	M 14X1,5	8	-0614	1.85	47	0.87	22				17	
T2600-0616	10	3/8	M 16X1,5	10	-0616	1.89	48	0.91	23			3/4	19	
T2600-0618	10	3/8	M 18X1,5	12	-0618	1.89	48	0.91	23			7/8	22	
T2600-0622	10	3/8	M 22X1,5	15	-0622	2.01	51	1.02	26			1.1/16	27	
T2600-0818	12	1/2	M 18X1,5	12	-0818	1.93	49	0.94	24			7/8	22	
T2600-0822	12	1/2	M 22X1,5	15	-0822	1.97	50	0.98	25			1.1/16	27	
T2600-0826	12	1/2	M 26X1,5	18	-0826	2.01	51	1.06	27			1.1/4	32	
T2600-1026	16	5/8	M 26X1,5	18	-1026	2.20	56	1.02	26			1.1/4	32	
T2600-1226	19	3/4	M 26X1,5	18	-1226	2.20	56	1.06	27			1.1/4	32	
T2600-1230	19	3/4	M 30X2	22	-1230	2.24	57	1.06	27				36	
T2600-1636	25	1	M 36X2	28	-1636	2.40	61	1.18	30			1.5/8	41	
T2600-2045	31	1.1/4	M 45X2	35	-2045	3.31	84	1.34	34			2	50	

### METRIC - DKL

### T2660

DKL FEMALE  
45° TUBE BEND

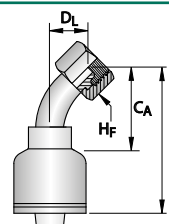

PART NO.	HOSE SIZE		THREAD SIZE	TUBE SIZE	DASH SIZE	DIMENSIONS						SPANNER		
	DN	inch				mm	mm	L		CA		DL		HF
						inch	mm	inch	mm	inch	mm	inch	mm	
T2660-0412	6	1/4	M 12X1,5	6	-0412	2.40	61	1.42	36	0.71	18		14	
T2660-0414	6	1/4	M 14X1,5	8	-0414	2.40	61	1.42	36	0.67	17		17	
T2660-0516	8	5/16	M 16X1,5	10	-0516	2.76	70	1.77	45	0.79	20	3/4	19	
T2660-0616	10	3/8	M 16X1,5	10	-0616	2.76	70	1.77	45	0.79	20	3/4	19	
T2660-0618	10	3/8	M 18X1,5	12	-0618	2.76	70	1.77	45	0.79	20	7/8	22	
T2660-0822	12	1/2	M 22X1,5	15	-0822	2.95	75	1.97	50	0.87	22	1.1/16	27	
T2660-0826	12	1/2	M 26X1,5	18	-0826	2.95	75	1.97	50	0.87	22	1.1/4	32	
T2660-1026	16	5/8	M 26X1,5	18	-1026	3.54	90	2.36	60	1.10	28	1.1/4	32	
T2660-1230	19	3/4	M 30X2	22	-1230	4.06	103	2.87	73	1.26	32		36	
T2660-1636	25	1	M 36X2	28	-1636	4.45	113	3.23	82	1.65	42	1.5/8	41	

## T2000 SERIES ONE-PIECE CRIMP COUPLINGS

### METRIC - DKL

### T2670

DKL FEMALE  
90° TUBE BEND

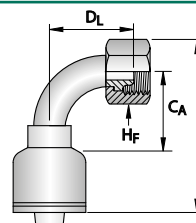

PART NO.	HOSE SIZE		THREAD SIZE	TUBE SIZE	DASH SIZE	DIMENSIONS						SPANNER			
	DN	inch				inch	mm	inch	mm	inch	mm	inch	mm	inch	mm
T2670-0412	6	1/4	M 12X1,5	6	-0412	2.05	52	1.06	27	1.22	31		14		
T2670-0414	6	1/4	M 14X1,5	8	-0414	2.05	52	1.06	27	1.22	31		17		
T2670-0416	6	1/4	M 16X1,5	10	-0416	2.05	52	1.06	27	1.26	32	3/4	19		
T2670-0614	10	3/8	M 14X1,5	8	-0614	2.28	58	1.30	33	1.22	31		17		
T2670-0616	10	3/8	M 16X1,5	10	-0616	2.36	60	1.38	35	1.38	35	3/4	19		
T2670-0618	10	3/8	M 18X1,5	12	-0618	2.32	59	1.34	34	1.38	35	7/8	22		
T2670-0622	10	3/8	M 22X1,5	15	-0622	2.32	59	1.34	34	1.46	37	1.1/16	27		
T2670-0822	12	1/2	M 22X1,5	15	-0822	2.56	65	1.57	40	1.73	44	1.1/16	27		
T2670-0826	12	1/2	M 26X1,5	18	-0826	2.44	62	1.46	37	1.97	50	1.1/4	32		
T2670-1026	16	5/8	M 26X1,5	18	-1026	3.03	77	1.85	47	2.09	53	1.1/4	32		
T2670-1230	19	3/4	M 30X2	22	-1230	3.39	86	2.20	56	2.52	64		36		
T2670-1636	25	1	M 36X2	28	-1636	3.94	100	2.72	69	2.87	73	1.5/8	41		

### METRIC - DKM

### T2610

DKM FEMALE  
60° CONE

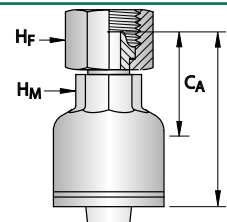

PART NO.	HOSE SIZE		THREAD SIZE	TUBE SIZE	DASH SIZE	DIMENSIONS						SPANNER			
	DN	inch				inch	mm	inch	mm	inch	mm	inch	mm	inch	mm
T2610-0616	10	3/8	M 16X1,5	10	-0616	1.91	49	0.94	24				19		
T2610-1230	19	3/4	M 30X2	22	-1230	2.17	55	0.98	25				36		
T2610-2052	31	1.1/4	M 52X2	42	-2052	3.53	90	1.56	40				60		
T2610-2452	38	1.1/2	M 52X2	42	-2452	3.62	92	1.59	41				60		

# ONE-PIECE COUPLINGS

## T2000 SERIES ONE-PIECE CRIMP COUPLINGS

METRIC - DKOL

T2501

DKOL FEMALE  
24° CONE

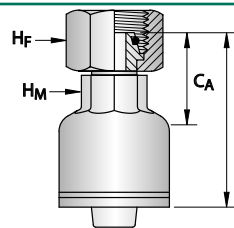

PART NO.	HOSE SIZE		THREAD SIZE	TUBE SIZE	DASH SIZE	DIMENSIONS				SPANNER					
	DN	inch				mm	mm	L		Ca		D <sub>L</sub>		H <sub>F</sub>	
						inch	mm	inch	mm			inch	mm	inch	mm
T2501-0312	5	3/16	M 12X1,5	6	-0312	1.61	41	0.83	21			14			
T2501-0412	6	1/4	M 12X1,5	6	-0412	1.81	46	0.83	21			14			
T2501-0414	6	1/4	M 14X1,5	8	-0414	2.05	52	1.02	26			17	1/2		
T2501-0416	6	1/4	M 16X1,5	10	-0416	2.13	54	1.10	28			3/4	19	1/2	
T2501-0514	8	5/16	M 14X1,5	8	-0514	1.85	47	0.87	22			17			
T2501-0516	8	5/16	M 16X1,5	10	-0516	2.13	54	1.14	29			3/4	19	9/16	
T2501-0518	8	5/16	M 18X1,5	12	-0518	2.17	55	1.14	29			7/8	22	9/16	
T2501-0612	10	3/8	M 12X1,5	6	-0612	2.05	52	1.05	27			14	5/8	16	
T2501-0614	10	3/8	M 14X1,5	8	-0614	2.05	52	1.06	27			17	5/8	16	
T2501-0616	10	3/8	M 16X1,5	10	-0616	2.13	54	1.14	29			3/4	19	5/8	16
T2501-0618	10	3/8	M 18X1,5	12	-0618	2.17	55	1.18	30			7/8	22	5/8	16
T2501-0622	10	3/8	M 22X1,5	15	-0622	2.24	57	1.26	32			1.1/16	27	5/8	16
T2501-0818	12	1/2	M 18X1,5	12	-0818	2.13	54	1.14	29			7/8	22	3/4	19
T2501-0822	12	1/2	M 22X1,5	15	-0822	2.24	57	1.26	32			1.1/16	27	3/4	19
T2501-0826	12	1/2	M 26X1,5	18	-0826	2.28	58	1.30	33			1.1/4	32	3/4	19
T2501-1026	16	5/8	M 26X1,5	18	-1026	2.56	65	1.34	34			1.1/4	32	7/8	22
T2501-1030	16	5/8	M 30X2	22	-1030	2.60	66	1.42	36			36	7/8	22	
T2501-1226	19	3/4	M 26X1,5	18	-1226	2.68	66	1.54	37			1.1/4	32	1.1/16	27
T2501-1230	19	3/4	M 30X2	22	-1230	2.68	66	1.50	36			36	1.1/16	27	
T2501-1636	25	1	M 36X2	28	-1636	2.91	74	1.69	39			1.5/8	41	1.1/4	32
T2501-2045	31	1.1/4	M 45X2	35	-2045	3.82	97	1.85	47			2	50	1.5/8	41
T2501-2452	38	1.1/2	M 52X2	42	-2452	3.43	87	1.38	35			2.3/8	60		

## T2000 SERIES ONE-PIECE CRIMP COUPLINGS

**METRIC - DKOL**

**T2510**

DKOL FEMALE  
24° CONE  
45° TUBE BEND

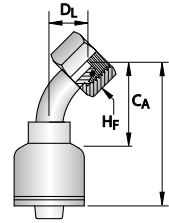

PART NO.	HOSE SIZE		THREAD SIZE	TUBE SIZE	DASH SIZE	DIMENSIONS						SPANNER		
	DN	inch	mm	mm		L		C <sub>A</sub>		D <sub>L</sub>		H <sub>F</sub>		H <sub>M</sub>
						inch	mm	inch	mm	inch	mm	inch	mm	
T2510-0412	6	1/4	M 12X1,5	6	-0412	2.40	61	1.42	36	0.71	18		14	
T2510-0414	6	1/4	M 14X1,5	8	-0414	2.36	60	1.38	35	0.67	17		17	
T2510-0416	6	1/4	M 16X1,5	10	-0416	2.36	60	1.38	35	0.67	17	3/4	19	
T2510-0418	6	1/4	M 18X1,5	12	-0418	2.44	62	1.46	37	0.79	20	7/8	22	
T2510-0516	8	5/16	M 16X1,5	10	-0516	2.76	70	1.77	45	0.79	20	3/4	19	
T2510-0518	8	5/16	M 18X1,5	12	-0518	2.76	70	1.77	45	0.79	20		22	
T2510-0612	10	3/8	M 12X1,5	6	-0612	2.68	68	1.69	43	0.67	17		14	
T2510-0616	10	3/8	M 16X1,5	10	-0616	2.76	70	1.77	45	0.75	19	3/4	19	
T2510-0618	10	3/8	M 18X1,5	12	-0618	2.76	70	1.77	45	0.79	20	7/8	22	
T2510-0822	12	1/2	M 22X1,5	15	-0822	3.03	77	2.05	52	0.87	22	1.1/16	27	
T2510-0826	12	1/2	M 26X1,5	18	-0826	3.07	78	2.09	53	0.94	24	1.1/4	32	
T2510-1026	16	5/8	M 26X1,5	18	-1026	3.50	89	2.28	58	1.10	28	1.1/4	32	
T2510-1030	16	5/8	M 30X2	22	-1030	3.54	90	2.36	60	1.14	29		36	
T2510-1230	19	3/4	M 30X2	22	-1230	4.09	102	2.91	72	1.22	31		36	
T2510-1636	25	1	M 36X2	28	-1636	4.84	123	3.62	94	1.81	46	1.5/8	41	
T2510-2045	31	1.1/4	M 45X2	35	-2045	5.91	150	3.98	101	1.57	40	2	50	
T2510-2452	38	1.1/2	M 52X2	42	-2452	6.65	169	4.65	118	1.93	49	2.3/8	60	

INTRODUCTION

INDEXES

ONE-PIECE  
COUPLINGS

PUSH-ON SUCTION &  
RETURN COUPLINGS

FIELD ATTACHABLE  
COUPLINGS

HYDRAULIC FITTINGS  
ACCESSORIES

# ONE-PIECE COUPLINGS

## T2000 SERIES ONE-PIECE CRIMP COUPLINGS

METRIC - DKOL

T2520

DKOL FEMALE  
24° CONE  
90° TUBE BEND

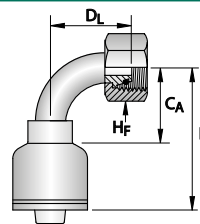

PART NO.	HOSE SIZE		THREAD SIZE	TUBE SIZE	DASH SIZE	DIMENSIONS						SPANNER			
	DN	inch				mm	mm	L		C <sub>A</sub>		D <sub>L</sub>		H <sub>F</sub>	
						inch	mm	inch	mm	inch	mm	inch	mm		
T2520-0412	6	1/4	M 12X1,5	6	-0412	2.05	52	1.06	27	1.22	31		14		
T2520-0414	6	1/4	M 14X1,5	8	-0414	2.28	58	1.30	33	1.22	31		17		
T2520-0416	6	1/4	M 16X1,5	10	-0416	2.05	52	1.06	27	1.22	31	3/4	19		
T2520-0418	6	1/4	M 18X1,5	12	-0418	2.28	58	1.30	33	1.34	34	7/8	22		
T2520-0516	8	5/16	M 16X1,5	10	-0516	2.32	59	1.34	34	1.38	35	3/4	19		
T2520-0518	8	5/16	M 18X1,5	12	-0518	2.40	61	1.42	36	1.38	35	7/8	22		
T2520-0616	10	3/8	M 16X1,5	10	-0616	2.36	60	1.38	35	1.42	36	3/4	19		
T2520-0618	10	3/8	M 18X1,5	12	-0618	2.36	60	1.38	35	1.38	35	7/8	22		
T2520-0622	10	3/8	M 22X1,5	15	-0622	2.56	65	1.57	40	1.73	44	1.1/16	27		
T2520-0822	12	1/2	M 22X1,5	15	-0822	2.60	66	1.61	41	1.73	44	1.1/16	27		
T2520-0826	12	1/2	M 26X1,5	18	-0826	2.60	66	1.61	41	1.89	48	1.1/4	32		
T2520-1026	16	5/8	M 26X1,5	18	-1026	3.07	78	1.89	48	2.13	54	1.1/4	32		
T2520-1230	19	3/4	M 30X2	22	-1230	3.50	87	2.32	57	2.56	65		36		
T2520-1636	25	1	M 36X2	28	-1636	3.94	100	2.72	45	3.11	79	1.5/8	41		
T2520-2045	31	1.1/4	M 45X2	35	-2045	5.87	149	3.94	100	2.99	76	2	50		
T2520-2452	38	1.1/2	M 52X2	42	-2452	5.94	151	3.90	99	4.02	102	2.3/8	60		

## T2000 SERIES ONE-PIECE CRIMP COUPLINGS

### METRIC - DKS

### T2630

DKS MALE  
24° SEAT

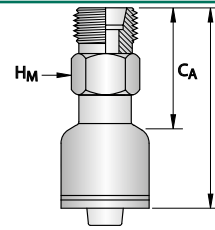

PART NO.	HOSE SIZE		THREAD SIZE	TUBE SIZE	DASH SIZE	DIMENSIONS				SPANNER					
	DN	inch	mm	mm		L		C <sub>A</sub>		D <sub>L</sub>		H <sub>F</sub>		H <sub>M</sub>	
						inch	mm	inch	mm					inch	mm
T2630-0414	6	1/4	M 14X1,5	6	-0414	2.09	53	1.06	27						17
T2630-0416	6	1/4	M 16X1,5	8	-0416	2.09	53	1.06	27						17
T2630-0418	6	1/4	M 18X1,5	10	-0418	1.93	49	0.94	24					3/4	19
T2630-0420	6	1/4	M 20X1,5	12	-0420	2.06	52	1.06	27						
T2630-0422	6	1/4	M 22X1,5	14	-0422	2.18	55	1.18	30						
T2630-0520	8	5/16	M 20X1,5	12	-0520	2.17	55	1.18	30					7/8	22
T2630-0618	10	3/8	M 18X1,5	10	-0618	1.89	48	0.94	24					3/4	19
T2630-0620	10	3/8	M 20X1,5	12	-0620	2.17	55	1.18	30					7/8	22
T2630-0622	10	3/8	M 22X1,5	14	-0622	2.13	54	1.14	29					15/16	24
T2630-0824	12	1/2	M 24X1,5	16	-0824	2.13	54	1.18	30					1.1/16	27
T2630-0830	12	1/2	M 30X2	20	-0830	2.20	56	1.26	32					1.1/4	32
T2630-1030	16	5/8	M 30X2	20	-1030	2.44	62	1.22	31					1.1/4	32
T2630-1230	19	3/4	M 30X2	20	-1230	2.56	65	1.38	35					1.1/4	32
T2630-1236	19	3/4	M 36X2	25	-1236	2.64	67	1.46	37					1.5/8	41
T2630-1636	25	1	M 36X2	25	-1636	2.83	72	1.61	41					1.5/8	41
T2630-1642	25	1	M 42X2	30	-1642	2.91	74	1.69	43						46
T2630-2042	31	1.1/4	M 42X2	30	-2042	3.86	98	1.89	48						46
T2630-2052	31	1.1/4	M 52X2	38	-2052	3.82	97	1.85	47					2.3/16	55
T2630-2452	38	1.1/2	M 52X2	38	-2452	4.12	105	2.09	53						

INTRODUCTION

INDEXES

ONE-PIECE  
COUPLINGS

PUSH-ON SUCTION &  
RETURN COUPLINGS

FIELD ATTACHABLE  
COUPLINGS

HYDRAULIC FITTINGS  
ACCESSORIES

# ONE-PIECE COUPLINGS

## T2000 SERIES ONE-PIECE CRIMP COUPLINGS

METRIC - DKOS

T2711

DKOS FEMALE  
24° CONE

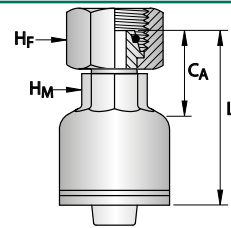

PART NO.	HOSE SIZE		THREAD SIZE	TUBE SIZE	DASH SIZE	DIMENSIONS				SPANNER					
	DN	inch				mm	mm	L		C <sub>A</sub>		D <sub>L</sub>		H <sub>F</sub>	
						inch	mm	inch	mm			inch	mm	inch	mm
T2711-0414	6	1/4	M 14X1,5	6	-0414	1.77	45	0.79	20				17		
T2711-0416	6	1/4	M 16X1,5	8	-0416	2.09	53	1.06	27			3/4	19	1/2	
T2711-0418	6	1/4	M 18X1,5	10	-0418	1.97	50	0.98	25			7/8	22		
T2711-0518	8	5/16	M 18X1,5	10	-0518	2.20	56	1.22	31			7/8	22	9/16	
T2711-0520	8	5/16	M 20X1,5	12	-0520	2.20	56	1.22	31			15/16	24	9/16	
T2711-0616	10	3/8	M 16X1,5	8	-0616	2.09	53	1.10	28			3/4	19	5/8	16
T2711-0618	10	3/8	M 18X1,5	10	-0618	2.20	56	1.22	31			7/8	22	5/8	16
T2711-0620	10	3/8	M 20X1,5	12	-0620	2.20	56	1.22	31			15/16	24	5/8	16
T2711-0622	10	3/8	M 22X1,5	14	-0622	2.28	58	1.30	33			1.1/16	27	5/8	16
T2711-0624	10	3/8	M 24X1,5	16	-0624	2.28	58	1.30	33			1.3/16	30	5/8	16
T2711-0820	12	1/2	M 20X1,5	12	-0820	2.20	56	1.22	31			15/16	24	3/4	19
T2711-0822	12	1/2	M 22X1,5	14	-0822	2.28	58	1.30	33			1.1/16	27	3/4	19
T2711-0824	12	1/2	M 24X1,5	16	-0824	2.28	58	1.30	33			1.3/16	30	3/4	19
T2711-1030	16	5/8	M 30X2	20	-1030	2.80	71	1.57	40				36	7/8	22
T2711-1230	19	3/4	M 30X2	20	-1230	2.80	69	1.65	40				36	1.1/16	24
T2711-1236	19	3/4	M 36X2	25	-1236	2.99	74	1.81	44				46	1.1/16	24
T2711-1636	25	1	M 36X2	25	-1636	2.99	76	1.81	42				46	1.1/4	32
T2711-1642	25	1	M 42X2	30	-1642	3.03	77	1.81	42			2	50	1.1/4	32
T2711-2042	31	1.1/4	M 42X2	30	-2042	3.46	88	1.50	38			2	50		
T2711-2052	31	1.1/4	M 52X2	38	-2052	3.66	93	1.69	43			2.3/8	60		
T2711-2452	38	1.1/2	M 52X2	38	-2452	3.78	96	1.73	44			2.3/8	60		

## T2000 SERIES ONE-PIECE CRIMP COUPLINGS

**METRIC - DKOS**

**T2720**

DKOS FEMALE  
24° CONE  
45° TUBE BEND

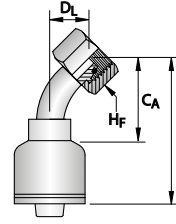

PART NO.	HOSE SIZE		THREAD SIZE	TUBE SIZE	DASH SIZE	DIMENSIONS						SPANNER		
	DN	inch	mm	mm		L		C <sub>A</sub>		D <sub>L</sub>		H <sub>F</sub>		H <sub>M</sub>
						inch	mm	inch	mm	inch	mm	inch	mm	
<b>T2720-0414</b>	6	1/4	M 14X1,5	6	-0414	2.36	60	1.38	35	0.63	16		17	
<b>T2720-0416</b>	6	1/4	M 16X1,5	8	-0416	2.40	61	1.42	36	0.67	17	3/4	19	
<b>T2720-0418</b>	6	1/4	M 18X1,5	10	-0418	2.36	60	1.38	35	0.67	17	7/8	22	
<b>T2720-0518</b>	8	5/16	M 18X1,5	10	-0518	2.80	71	1.81	46	0.67	17	7/8	22	
<b>T2720-0520</b>	8	5/16	M 20X1,5	12	-0520	2.80	71	1.81	46	0.79	20	15/16	24	
<b>T2720-0616</b>	10	3/8	M 16X1,5	8	-0616	2.56	65	1.57	40	0.67	17	3/4	19	
<b>T2720-0618</b>	10	3/8	M 18X1,5	10	-0618	2.76	70	1.77	45	0.67	17	7/8	22	
<b>T2720-0620</b>	10	3/8	M 20X1,5	12	-0620	2.80	71	1.81	46	0.79	20	15/16	24	
<b>T2720-0622</b>	10	3/8	M 22X1,5	14	-0622	2.80	71	1.81	46	0.79	20	1.1/16	27	
<b>T2720-0822</b>	12	1/2	M 22X1,5	14	-0822	3.07	78	2.09	53	0.94	24	1.1/16	27	
<b>T2720-0824</b>	12	1/2	M 24X1,5	16	-0824	3.07	78	2.09	53	0.94	24	1.3/16	30	
<b>T2720-1030</b>	16	5/8	M 30X2	20	-1030	3.66	93	2.48	63	1.22	31		36	
<b>T2720-1230</b>	19	3/4	M 30X2	20	-1230	4.09	102	2.91	72	1.38	35		36	
<b>T2720-1236</b>	19	3/4	M 36X2	25	-1236	4.17	104	2.99	74	1.38	35		46	
<b>T2720-1636</b>	25	1	M 36X2	25	-1636	4.76	121	3.54	83	1.38	35		46	
<b>T2720-1642</b>	25	1	M 42X2	30	-1642	4.65	118	3.43	85	1.46	37	2	50	32
<b>T2720-2052</b>	31	1.1/4	M 52X2	38	-2052	6.14	156	4.17	106	1.89	48	2.3/8	60	

INTRODUCTION

INDEXES

ONE-PIECE  
COUPLINGS

PUSH-ON SUCTION &  
RETURN COUPLINGS

FIELD ATTACHABLE  
COUPLINGS

HYDRAULIC FITTINGS  
ACCESSORIES

# ONE-PIECE COUPLINGS

## T2000 SERIES ONE-PIECE CRIMP COUPLINGS

METRIC - DKOS

T2730

DKOS FEMALE  
24° CONE  
90° TUBE BEND

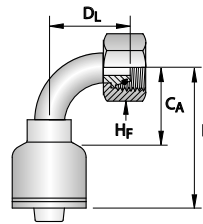

PART NO.	HOSE SIZE		THREAD SIZE	TUBE SIZE	DASH SIZE	DIMENSIONS						SPANNER			
	DN	inch	mm	mm		L		CA		DL		HF		HM	
						inch	mm	inch	mm	inch	mm	inch	mm		
T2730-0414	6	1/4	M 14X1,5	6	-0414	2.05	52	1.06	27	1.10	28		17		
T2730-0416	6	1/4	M 16X1,5	8	-0416	2.05	52	1.06	27	1.22	31	3/4	19		
T2730-0418	6	1/4	M 18X1,5	10	-0418	2.28	58	1.30	33	1.26	32	7/8	22		
T2730-0520	8	5/16	M 20X1,5	12	-0520	2.40	61	1.42	36	1.42	36	15/16	24		
T2730-0616	10	3/8	M 16X1,5	8	-0616	2.36	60	1.38	35	1.26	32	3/4	19		
T2730-0618	10	3/8	M 18X1,5	10	-0618	2.05	52	1.06	27	1.18	30	7/8	22		
T2730-0620	10	3/8	M 20X1,5	12	-0620	2.40	61	1.42	36	1.42	36	15/16	24		
T2730-0622	10	3/8	M 22X1,5	14	-0622	2.40	61	1.42	36	1.42	36	1.1/16	27		
T2730-0822	12	1/2	M 22X1,5	14	-0822	2.60	66	1.61	41	1.89	48	1.1/16	27		
T2730-0824	12	1/2	M 24X1,5	16	-0824	2.60	66	1.61	41	1.89	48	1.3/16	30		
T2730-1030	16	5/8	M 30X2	20	-1030	2.95	75	1.77	45	2.28	58		36		
T2730-1230	19	3/4	M 30X2	20	-1230	3.50	87	2.32	57	2.68	68		36		
T2730-1236	19	3/4	M 36X2	25	-1236	3.50	87	2.32	57	2.68	68		46		
T2730-1636	25	1	M 36X2	25	-1636	3.94	100	2.72	74	3.03	77		46		
T2730-1642	25	1	M 42X2	30	-1642	3.94	100	2.72	74	3.03	77	2	50		
T2730-2052	31	1.1/4	M 52X2	38	-2052	5.31	135	3.35	85	3.50	89	2.3/8	60		
T2730-2452	38	1.1/2	M 52X2	38	-2452	5.63	143	3.58	91	3.50	89	2.3/8	60		

## T2000 SERIES ONE-PIECE CRIMP COUPLINGS

### METRIC BANJO

### T2470

METRIC BANJO  
STRAIGHT

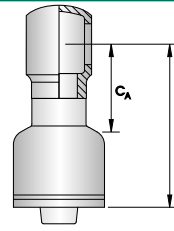

PART NO.	HOSE SIZE		THREAD SIZE	TUBE SIZE	DASH SIZE	DIMENSIONS				SPANNER				
	DN	inch	mm	inch		L		CA		DL	HF	HM		
						inch	mm	inch	mm					
T2470-0412	6	1/4	12		-0412	1.89	48	0.91	23					
T2470-0414	6	1/4	14		-0414	1.97	50	0.98	25					
T2470-0416	6	1/4	16		-0416	2.05	52	1.06	27					
T2470-0512	8	5/16	12		-0512	1.97	50	0.98	25					
T2470-0514	8	5/16	14		-0514	2.52	64	1.54	39					
T2470-0516	8	5/16	16		-0516	2.05	52	1.06	27					
T2470-0612	10	3/8	12		-0612	1.97	50	0.98	25					
T2470-0614	10	3/8	14		-0614	2.05	52	1.06	27					
T2470-0616	10	3/8	16		-0616	2.05	52	1.06	27					
T2470-0618	10	3/8	18		-0618	2.13	54	1.14	29					
T2470-0620	10	3/8	20		-0620	2.13	54	1.14	29					
T2470-0622	10	3/8	22		-0622	2.32	59	1.34	34					
T2470-0818	12	1/2	18		-0818	2.13	54	1.18	30					
T2470-0822	12	1/2	22		-0822	2.24	57	1.30	33					
T2470-1022	16	5/8	22		-1022	2.48	63	1.26	32					
T2470-1026	16	5/8	26		-1026	2.66	68	1.47	37					
T2470-1226	19	3/4	26		-1226	2.68	68	1.50	38					
T2470-1230	19	3/4	30		-1230	2.91	74	1.73	44					
T2470-1236	19	3/4	36		-1236	3.46	88	2.28	58					
T2470-1630	25	1	30		-1630	3.03	77	1.81	46					
T2470-1636	25	1	36		-1636	3.50	89	2.28	58					

INTRODUCTION

INDEXES

ONE-PIECE  
COUPLINGS

PUSH-ON SUCTION &  
RETURN COUPLINGS

FIELD ATTACHABLE  
COUPLINGS

HYDRAULIC FITTINGS  
ACCESSORIES

# ONE-PIECE COUPLINGS

## T2000 SERIES ONE-PIECE CRIMP COUPLINGS

ORFS

T2840

ORFS MALE

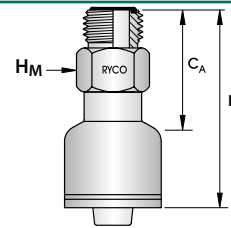

PART NO.	HOSE SIZE		THREAD SIZE	TUBE SIZE	DASH SIZE	DIMENSIONS				SPANNER					
	DN	inch	inch			L		C <sub>A</sub>		D <sub>L</sub>		H <sub>F</sub>		H <sub>M</sub>	
						inch	mm	inch	mm			inch	mm	inch	mm
T2840-0409	6	1/4	9/16" - 18		-0409	1.97	50	0.98	25					5/8	16
T2840-0411	6	1/4	11/16" - 16		-0411	2.05	52	1.06	27					3/4	19
T2840-0611	10	3/8	11/16" - 16		-0611	2.13	54	1.14	29					3/4	19
T2840-0613	10	3/8	13/16" - 16		-0613	2.20	56	1.22	31					7/8	22
T2840-0616	10	3/8	1" - 14		-0616	2.36	60	1.38	35					1 1/16	27
T2840-0813	12	1/2	13/16" - 16		-0813	2.28	58	1.30	33					7/8	22
T2840-0816	12	1/2	1" - 14		-0816	2.36	60	1.42	36					1.1/16	27
T2840-1016	16	5/8	1" - 14		-1016	2.64	67	1.46	37					1.1/16	27
T2840-1019	16	5/8	1.3/16" - 12		-1019	2.68	68	1.50	38					1.1/4	32
T2840-1219	19	3/4	1.3/16" - 12		-1219	2.72	69	1.54	39					1.1/4	32
T2840-1223	19	3/4	1.7/16" - 12		-1223	2.72	69	1.57	40					1.1/2	38
T2840-1623	25	1	1.7/16" - 12		-1623	2.83	72	1.61	41					1.1/2	38
T2840-2027	31	1.1/4	1.11/16" - 12		-2027	3.74	95	1.77	45					1.3/4	

ORFS

T2800

ORFS FEMALE

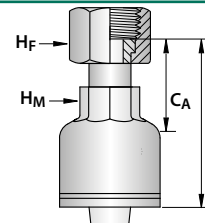

PART NO.	HOSE SIZE		THREAD SIZE	TUBE SIZE	DASH SIZE	DIMENSIONS				SPANNER					
	DN	inch	inch			L		C <sub>A</sub>		D <sub>L</sub>		H <sub>F</sub>		H <sub>M</sub>	
						inch	mm	inch	mm			inch	mm	inch	mm
T2800-0409	6	1/4	9/16" - 18		-0409	2.17	55	1.14	29			11/16		1/2	
T2800-0411	6	1/4	11/16" - 16		-0411	2.20	56	1.22	31			13/16		1/2	
T2800-0511	8	5/16	11/16" - 16		-0511	2.20	56	1.18	30			13/16		5/8	16
T2800-0609	10	3/8	9/16" - 18		-0609	2.20	56	1.22	31			11/16		5/8	16
T2800-0611	10	3/8	11/16" - 16		-0611	2.24	57	1.26	32			7/8	22	5/8	16
T2800-0613	10	3/8	13/16" - 16		-0613	2.36	60	1.38	35			15/16	24	5/8	16
T2800-0811	12	1/2	11/16" - 16		-0811	2.28	58	1.30	33			7/8	22	3/4	19
T2800-0813	12	1/2	13/16" - 16		-0813	2.40	61	1.42	36			15/16	24	3/4	19
T2800-0816	12	1/2	1" - 14		-0816	2.56	63	1.57	38			1.1/8		15/16	19
T2800-0819	12	1/2	1.3/16" - 12		-0819	2.60	66	1.65	42			1.3/8	35	3/4	19
T2800-1016	16	5/8	1" - 14		-1016	2.80	71	1.57	40			1.1/8		7/8	22
T2800-1019	16	5/8	1.3/16" - 12		-1019	2.91	74	1.69	43			1.3/8	35	7/8	22
T2800-1216	19	3/4	1" - 14		-1216	2.68	71	1.54	42			1.1/8		1	24
T2800-1219	19	3/4	1.3/16" - 12		-1219	2.87	73	1.61	41			1.3/8	35	15/16	24
T2800-1223	19	3/4	1.7/16" - 12		-1223	2.99	74	1.85	45			1.5/8	41	1.1/16	24
T2800-1619	25	1	1.3/16" - 12		-1619	3.07	78	1.85	45			1.3/8	35	1.1/4	32
T2800-1623	25	1	1.7/16" - 12		-1623	3.07	78	1.89	42			1.5/8	41	1.1/4	32
T2800-2027	31	1.1/4	1.11/16" - 12		-2027	4.13	105	2.17	55			2	50	1.5/8	41
T2800-2432	38	1.1/2	2" - 12		-2432	4.33	110	2.32	59			2.1/4	57	2	50

## T2000 SERIES ONE-PIECE CRIMP COUPLINGS

### ORFS

### T2801

ORFS FEMALE  
(ROUND BAR)

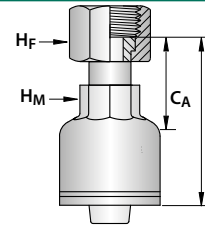

PART NO.	HOSE SIZE		THREAD SIZE	TUBE SIZE	DASH SIZE	DIMENSIONS						SPANNER			
	DN	inch	inch			L		C <sub>A</sub>		D <sub>L</sub>		H <sub>F</sub>		H <sub>M</sub>	
						inch	mm	inch	mm	inch	mm	inch	mm	inch	mm
T2801-0409	6	1/4	9/16" - 18		-0409	2.17	55	1.14	29				17	1/2	
T2801-0411	6	1/4	11/16" - 16		-0411	2.20	56	1.22	31			7/8	22	1/2	
T2801-0511	8	5/16	11/16" - 16		-0511	2.24	57	1.26	32			7/8	22	9/16	
T2801-0609	10	3/8	9/16" - 18		-0609	2.20	56	1.22	31				17	5/8	16
T2801-0816	12	1/2	1" - 14		-0816	2.48	63	1.50	38			1.3/16	30	3/4	19
T2801-0819	12	1/2	1.3/16" - 12		-0819	2.60	66	1.65	42				36	3/4	19
T2801-1016	16	5/8	1" - 14		-1016	2.80	71	1.57	40			1.3/16	30	7/8	22
T2801-1019	16	5/8	1.3/16" - 12		-1019	2.91	74	1.69	43				36	7/8	22
T2801-1219	19	3/4	1.3/16" - 12		-1219	2.87	73	1.61	41				36	15/16	24

### ORFS

### T2813

ORFS FEMALE  
45° SHORT TUBE BEND

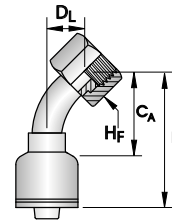

PART NO.	HOSE SIZE		THREAD SIZE	TUBE SIZE	DASH SIZE	DIMENSIONS						SPANNER			
	DN	inch	inch			L		C <sub>A</sub>		D <sub>L</sub>		H <sub>F</sub>		H <sub>M</sub>	
						inch	mm	inch	mm	inch	mm	inch	mm		
T2813-0409	6	1/4	9/16" - 18		-0409	2.28	58	1.30	33	0.43	11	11/16			
T2813-0611	10	3/8	11/16" - 16		-0611	2.48	63	1.50	38	0.47	12	7/8	22		
T2813-0813	12	1/2	13/16" - 16		-0813	2.72	69	1.73	44	0.59	15	15/16	24		
T2813-1016	16	5/8	1" - 14		-1016	2.99	76	1.77	45	0.63	16	1.1/8			
T2813-1219	19	3/4	1.3/16" - 12		-1219	3.62	92	2.36	60	0.83	21	1.3/8			

### ORFS

### T2814

ORFS FEMALE 45°  
SHORT TUBE BEND METRIC NUT ONLY

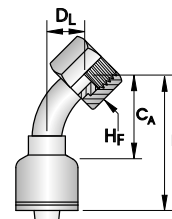

PART NO.	HOSE SIZE		THREAD SIZE	TUBE SIZE	DASH SIZE	DIMENSIONS						SPANNER			
	DN	inch	inch			L		C <sub>A</sub>		D <sub>L</sub>		H <sub>F</sub>		H <sub>M</sub>	
						inch	mm	inch	mm	inch	mm	inch	mm		
T2814-0409	6	1/4	9/16" - 18		-0409	2.28	58	1.30	33	0.43	11		17		
T2814-1016	16	5/8	1" - 14		-1016	2.99	76	1.77	45	0.63	16	1.3/16	30		
T2814-1219	19	3/4	1.3/16" - 12		-1219	3.62	92	2.36	60	0.83	21		36		

# ONE-PIECE COUPLINGS

## T2000 SERIES ONE-PIECE CRIMP COUPLINGS

ORFS

T2810

ORFS FEMALE  
45° TUBE BEND

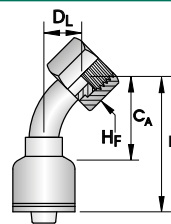

PART NO.	HOSE SIZE		THREAD SIZE	TUBE SIZE	DASH SIZE	DIMENSIONS						SPANNER			
	DN	inch	inch			L		CA		DL		HF		HM	
						inch	mm	inch	mm	inch	mm	inch	mm		
T2810-0409	6	1/4	9/16" - 18		-0409	2.52	64	1.54	39	0.71	18	11/16			
T2810-0411	6	1/4	11/16" - 16		-0411	2.52	64	1.54	39	0.71	18	13/16			
T2810-0611	10	3/8	11/16" - 16		-0611	2.76	70	1.77	45	0.79	20	7/8	22		
T2810-0613	10	3/8	13/16" - 16		-0613	2.56	65	1.57	40	0.67	17	15/16	24		
T2810-0811	12	1/2	11/16" - 16		-0811	3.11	79	2.13	54	0.87	22	7/8	22		
T2810-0813	12	1/2	13/16" - 16		-0813	2.87	73	1.93	49	0.75	19	15/16	24		
T2810-0816	12	1/2	1" - 14		-0816	2.87	73	1.89	48	0.75	19	1.1/8			
T2810-1016	16	5/8	1" - 14		-1016	3.50	89	2.32	59	0.79	20	1.1/8			
T2810-1019	16	5/8	1.3/16" - 12		-1019	3.50	89	2.32	59	0.94	24	1.3/8	35		
T2810-1219	19	3/4	1.3/16" - 12		-1219	4.29	109	3.03	77	1.14	29	1.3/8	35		
T2810-1223	19	3/4	1.7/16" - 12		-1223	4.17	104	3.03	75	1.02	26	1.5/8	41		
T2810-1623	25	1	1.7/16" - 12		-1623	4.61	117	3.39	84	1.34	34	1.5/8	41		
T2810-2027	31	1.1/4	1.11/16" - 12		-2027	5.94	151	4.02	102	1.77	45	2	50		

ORFS

T2811

ORFS FEMALE  
45° TUBE BEND  
METRIC NUT ONLY

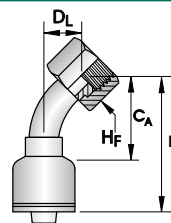

PART NO.	HOSE SIZE		THREAD SIZE	TUBE SIZE	DASH SIZE	DIMENSIONS						SPANNER			
	DN	inch	inch			L		CA		DL		HF		HM	
						inch	mm	inch	mm	inch	mm	inch	mm		
T2811-0409	6	1/4	9/16" - 18		-0409	2.52	64	1.54	39	0.71	18		17		
T2811-0411	6	1/4	11/16" - 16		-0411	2.52	64	1.54	39	0.71	18	7/8	22		
T2811-0816	12	1/2	1" - 14		-0816	2.87	73	1.89	48	0.75	19	1.3/16	30		
T2811-1016	16	5/8	1" - 14		-1016	3.54	90	2.32	59	0.79	20	1.3/16	30		
T2811-1019	16	5/8	1.3/16" - 12		-1019	3.54	90	2.32	59	0.94	24		36		
T2811-1219	19	3/4	1.3/16" - 12		-1219	4.29	109	3.03	77	1.14	29		36		

## T2000 SERIES ONE-PIECE CRIMP COUPLINGS

### ORFS

### T2823

ORFS FEMALE  
90° SHORT TUBE BEND

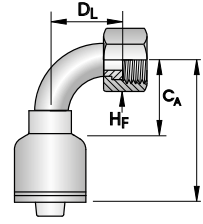

PART NO.	HOSE SIZE		THREAD SIZE	TUBE SIZE	DASH SIZE	DIMENSIONS						SPANNER		
	DN	inch	inch			L		CA		DL		HF		HM
						inch	mm	inch	mm	inch	mm	inch	mm	
T2823-0409	6	1/4	9/16" - 18		-0409	2.05	52	1.06	27	0.83	21	11/16		
T2823-0411	6	1/4	11/16" - 16		-0411	2.01	51	1.02	26	1.06	27	13/16		
T2823-0611	10	3/8	11/16" - 16		-0611	2.24	57	1.26	32	0.94	24	7/8	22	
T2823-0613	10	3/8	13/16" - 16		-0613	2.36	60	1.38	35	1.14	29	15/16	24	
T2823-0813	12	1/2	13/16" - 16		-0813	2.68	68	1.69	43	1.18	30	15/16	24	
T2823-0816	12	1/2	1" - 14		-0816	2.60	66	1.65	42	1.38	35	1.1/8		
T2823-0819	12	1/2	1.3/16" - 12		-0819	2.64	67	1.65	42	1.89	48	1.3/8	35	
T2823-1016	16	5/8	1" - 14		-1016	2.76	70	1.57	40	1.26	32	1.1/8		
T2823-1019	16	5/8	1.3/16" - 12		-1019	2.99	76	1.77	45	1.89	48	1.3/8	35	
T2823-1219	19	3/4	1.3/16" - 12		-1219	3.50	89	2.24	57	1.89	48	1.3/8	35	
T2823-1223	19	3/4	1.7/16" - 12		-1223	3.50	87	2.32	57	2.20	56	1.5/8	41	
T2823-1623	25	1	1.7/16" - 12		-1623	4.41	112	3.19	79	2.20	56	1.5/8	41	
T2823-2027	31	1.1/4	1.11/16" - 12		-2027	5.87	149	3.94	100	2.52	64	2	50	

### ORFS

### T2824

ORFS FEMALE  
90° SHORT TUBE BEND  
METRIC NUT ONLY

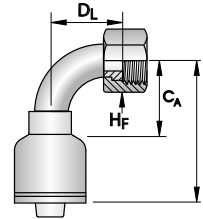

PART NO.	HOSE SIZE		THREAD SIZE	TUBE SIZE	DASH SIZE	DIMENSIONS						SPANNER		
	DN	inch	inch			L		CA		DL		HF		HM
						inch	mm	inch	mm	inch	mm	inch	mm	
T2824-0409	6	1/4	9/16" - 18		-0409	2.05	52	1.06	27	0.83	21		17	
T2824-0411	6	1/4	11/16" - 16		-0411	2.01	51	1.02	26	1.06	27	7/8	22	
T2824-0816	12	1/2	1" - 14		-0816	2.60	66	1.65	42	1.38	35	1.3/16	30	
T2824-0819	12	1/2	1.3/16" - 12		-0819	2.64	67	1.65	42	1.89	48		36	
T2824-1016	16	5/8	1" - 14		-1016	2.99	76	1.77	45	1.26	32	1.3/16	30	
T2824-1019	16	5/8	1.3/16" - 12		-1019	2.99	76	1.77	45	1.89	48		36	
T2824-1219	19	3/4	1.3/16" - 12		-1219	3.50	89	2.24	57	1.89	48		36	

# ONE-PIECE COUPLINGS

## T2000 SERIES ONE-PIECE CRIMP COUPLINGS

ORFS

T2820

ORFS FEMALE  
90° MEDIUM TUBE BEND

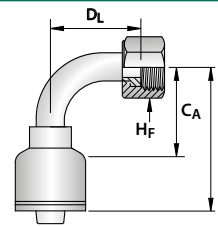

PART NO.	HOSE SIZE		THREAD SIZE	TUBE SIZE	DASH SIZE	DIMENSIONS						SPANNER			
	DN	inch	inch			L		CA		DL		HF		HM	
						inch	mm	inch	mm	inch	mm	inch	mm		
T2820-0409	6	1/4	9/16" - 18		-0409	2.28	58	1.30	33	1.26	32	11/16			
T2820-0411	6	1/4	11/16" - 16		-0411	2.28	58	1.30	33	1.50	38	13/16			
T2820-0511	8	5/16	11/16" - 16		-0511	2.32	59	1.34	34	1.50	38	13/16			
T2820-0611	10	3/8	11/16" - 16		-0611	2.36	60	1.38	35	1.50	38	7/8	22		
T2820-0613	10	3/8	13/16" - 16		-0613	2.48	63	1.50	38	1.34	34	15/16	24		
T2820-0813	12	1/2	13/16" - 16		-0813	2.60	66	1.61	41	1.61	41	15/16	24		
T2820-0816	12	1/2	1" - 14		-0816	2.60	66	1.61	41	1.85	47	1.1/8			
T2820-0819	12	1/2	1.3/16" - 12		-0819	2.60	66	1.61	41	2.28	58	1.3/8	35		
T2820-1016	16	5/8	1" - 14		-1016	2.99	76	1.81	46	1.85	47	1.1/8			
T2820-1019	16	5/8	1.3/16" - 12		-1019	2.99	76	1.81	46	2.28	58	1.3/8	35		
T2820-1213	19	3/4	13/16" - 16		-1213	3.35	83	2.17	53	1.61	41	15/16	24		
T2820-1216	19	3/4	1" - 14		-1216	3.35	83	2.17	53	1.85	47	1.1/8			
T2820-1219	19	3/4	1.3/16" - 12		-1219	3.50	89	2.24	57	2.32	59	1.3/8	35		
T2820-1223	19	3/4	1.7/16" - 12		-1223	3.50	87	2.32	57	2.09	53	1.5/8	41		
T2820-1623	25	1	1.7/16" - 12		-1623	3.94	100	2.72	74	2.80	71	1.5/8	41		
T2820-2027	31	1.1/4	1.11/16" - 12		-2027	5.87	149	3.94	100	3.54	90	2	50		

## T2000 SERIES ONE-PIECE CRIMP COUPLINGS

### ORFS

### T2821

ORFS FEMALE  
90° MEDIUM TUBE BEND  
METRIC NUT ONLY

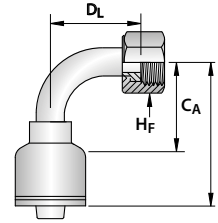

PART NO.	HOSE SIZE		THREAD SIZE	TUBE SIZE	DASH SIZE	DIMENSIONS						SPANNER			
	DN	inch	inch			L		C <sub>A</sub>		D <sub>L</sub>		H <sub>F</sub>		H <sub>M</sub>	
T2821-0409	6	1/4	9/16" - 18		-0409	2.28	58	1.30	33	1.26	32		17		
T2821-0411	6	1/4	11/16" - 16		-0411	2.28	58	1.30	33	1.50	38	7/8	22		
T2821-0511	8	5/16	11/16" - 16		-0511	2.32	59	1.34	34	1.50	38	7/8	22		
T2821-0816	12	1/2	1" - 14		-0816	2.60	66	1.61	41	1.85	47	1.3/16	30		
T2821-0819	12	1/2	1.3/16" - 12		-0819	2.60	66	1.61	41	2.28	58		36		
T2821-1016	16	5/8	1" - 14		-1016	2.99	76	1.77	45	1.85	47	1.3/16	30		
T2821-1019	16	5/8	1.3/16" - 12		-1019	2.99	76	1.77	45	2.28	58		36		
T2821-1216	19	3/4	1" - 14		-1216	3.35	83	2.17	53	1.85	47	1.3/16	30		
T2821-1219	19	3/4	1.3/16" - 12		-1219	3.50	89	2.24	57	2.32	59		36		

### ORFS

### T2830

ORFS FEMALE  
90° LONG TUBE BEND

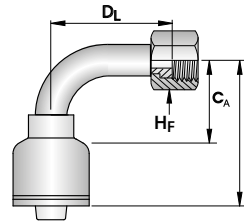

PART NO.	HOSE SIZE		THREAD SIZE	TUBE SIZE	DASH SIZE	DIMENSIONS						SPANNER			
	DN	inch	inch			L		C <sub>A</sub>		D <sub>L</sub>		H <sub>F</sub>		H <sub>M</sub>	
T2830-0409	6	1/4	9/16" - 18		-0409	2.28	58	1.30	33	1.85	47	11/16			
T2830-0411	6	1/4	11/16" - 16		-0411	2.09	53	1.10	28	2.13	54	13/16			
T2830-0611	10	3/8	11/16" - 16		-0611	2.36	60	1.38	35	2.17	55	7/8	22		
T2830-0613	10	3/8	13/16" - 16		-0613	2.36	60	1.38	35	2.52	64	15/16	24		
T2830-0813	12	1/2	13/16" - 16		-0813	2.68	68	1.69	43	2.56	65	15/16	24		
T2830-0816	12	1/2	1" - 14		-0816	2.80	71	1.81	46	2.76	70	1.1/8			
T2830-0819	12	1/2	1.3/16" - 12		-0819	2.64	67	1.69	43	3.78	96	1.3/8	35		
T2830-1016	16	5/8	1" - 14		-1016	3.23	82	2.01	51	2.76	70	1.1/8			
T2830-1019	16	5/8	1.3/16" - 12		-1019	3.23	82	2.01	51	3.78	96	1.3/8	35		
T2830-1219	19	3/4	1.3/16" - 12		-1219	3.50	89	2.24	57	3.78	96	1.3/8	35		
T2830-1223	19	3/4	1.7/16" - 12		-1223	3.50	87	2.32	57	4.49	114	1.5/8	41		
T2830-1623	25	1	1.7/16" - 12		-1623	4.13	105	2.91	74	4.45	113	1.5/8	41		
T2830-2027	31	1.1/4	1.11/16" - 12		-2027	5.87	149	3.94	100	5.08	129	2	50		

# ONE-PIECE COUPLINGS

## T2000 SERIES ONE-PIECE CRIMP COUPLINGS

**ORFS**

**T2831**

ORFS FEMALE  
90° LONG TUBE BEND  
METRIC NUT ONLY

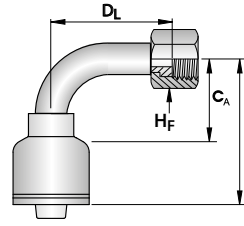

PART NO.	HOSE SIZE		THREAD SIZE	TUBE SIZE	DASH SIZE	DIMENSIONS						SPANNER		
	DN	inch	inch			L		CA		DL		HF		HM
T2831-0409	6	1/4	9/16" - 18		-0409	2.28	58	1.30	33	1.85	47		17	
T2831-0411	6	1/4	11/16" - 16		-0411	2.28	58	1.30	33	2.13	54	7/8	22	
T2831-0816	12	1/2	1" - 14		-0816	2.80	71	1.81	46	2.76	70	1.3/16	30	
T2831-0819	12	1/2	1.3/16" - 12		-0819	2.64	67	1.69	43	3.78	96		36	
T2831-1016	16	5/8	1" - 14		-1016	3.23	82	2.01	51	2.76	70	1.3/16	30	
T2831-1019	16	5/8	1.3/16" - 12		-1019	3.23	82	2.01	51	3.78	96		36	
T2831-1219	19	3/4	1.3/16" - 12		-1219	3.50	89	2.24	57	3.78	96		36	

**PW**

**T2940**

PW FEMALE  
PRESSURE WASHER  
SUITS KARCHER STYLE

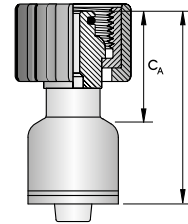

PART NO.	HOSE SIZE		THREAD SIZE	TUBE SIZE	DASH SIZE	DIMENSIONS						SPANNER	
	DN	inch	inch			L		CA		DL	HF	HM	
T2940-0422	6	1/4	M22 X 1,5		-0422	2.17	55	1.18	30				
T2940-0522	8	5/16	M22 X 1,5		-0522	2.17	55	1.18	30				
T2940-0622	10	3/8	M22 X 1,5		-0622	2.17	55	1.18	30				

**PW**

**T2950**

PW GUN HANDLE TUBE  
PRESSURE WASHER  
SUITS KARCHER STYLE

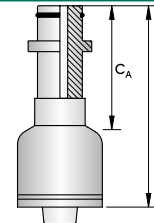

PART NO.	HOSE SIZE		THREAD SIZE	TUBE SIZE	DASH SIZE	DIMENSIONS						SPANNER	
	DN	inch	inch			L		CA		DL	HF	HM	
T2950-0410	6	1/4		9,8	-0410	2.56	65	1.54	39				
T2950-0510	8	5/16		9,8	-0510	2.56	65	1.57	40				

## T2000 SERIES ONE-PIECE CRIMP COUPLINGS

### RYCOLOK

### T2870

RYCOLOK MALE  
STAPLE

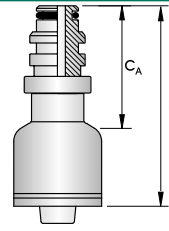

PART NO.	HOSE SIZE		THREAD SIZE	TUBE SIZE	DASH SIZE	DIMENSIONS				SPANNER					
	DN	inch	inch	mm		L		C <sub>A</sub>		D <sub>L</sub>		H <sub>F</sub>		H <sub>M</sub>	
	DN	inch	inch	mm		inch	mm	inch	mm	inch	mm	inch	mm	inch	mm
T2870-0406	6	1/4	-	6	-0406	2.52	64	1.54	39						
T2870-0410	6	1/4	-	10	-0410	2.56	65	1.57	40						
T2870-0610	10	3/8	-	10	-0610	2.48	63	1.50	38						
T2870-0812	12	1/2	-	12	-0812	2.56	65	1.61	41						
T2870-0816	12	1/2	-	16	-0816	2.56	65	1.61	41						
T2870-1012	16	5/8	-	12	-1012	2.80	71	1.57	40						
T2870-1016	16	5/8	-	16	-1016	2.72	69	1.54	39						
T2870-1220	19	3/4	-	20	-1220	2.72	69	1.54	39						
T2870-1625	25	1	-	25	-1625	3.19	81	1.97	50						
T2870-2032	31	1.1/4	-	32	-2032	3.94	100	1.97	50						
T2870-2440	38	1.1/2	-	40	-2440	4.37	111	2.36	60						
T2870-3250	51	2	-	50	-3250	4.49	114	2.28	58						
T2870-4063	63	2.1/2	-	63	-4063	6.57	167	3.54	90						
T2870-4875	76	3	-	75	-4875	7.99	203	5.00	127						

### RYCOLOK

### T2871

RYCOLOK MALE  
45° ELBOW  
STAPLE

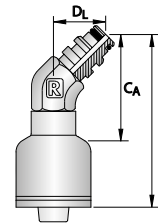

PART NO.	HOSE SIZE		THREAD SIZE	TUBE SIZE	DASH SIZE	DIMENSIONS				SPANNER					
	DN	inch	inch	inch		L		C <sub>A</sub>		D <sub>L</sub>		H <sub>F</sub>		H <sub>M</sub>	
	DN	inch	inch	inch		inch	mm	inch	mm	inch	mm	inch	mm	inch	mm
T2871-0406	6	1/4	-	6	-0406	2.76	70	1.73	44	1.06	27				
T2871-0410	6	1/4	-	10	-0410	2.87	73	1.89	48	1.06	27				
T2871-0610	10	3/8	-	10	-0610	2.72	69	1.77	45	1.06	27			7/8	22
T2871-0812	12	1/2	-	12	-0812	2.99	76	2.02	51	1.06	27				
T2871-1220	19	3/4	-	20	-1220	3.21	82	2.05	52	1.27	32				
T2871-1625	25	1	-	25	-1625	3.67	93	2.44	62	1.26	32				
T2871-2032	31	1.1/4	-	32	-2032	4.49	114	2.52	64	1.43	36				
T2871-2440	38	1.1/2	-	40	-2440	5.28	134	3.23	82	1.73	44			0	
T2871-3250	51	2	-	50	-3250	5.63	143	3.43	87	1.81	46			0	
T2871-4063	63	2.1/2	-	63	-4063	7.52	191	4.49	114	2.87	73				

# ONE-PIECE COUPLINGS

## T2000 SERIES ONE-PIECE CRIMP COUPLINGS

**RYCOLOK**

**T2872**

RYCOLOK MALE  
90° ELBOW  
STAPLE

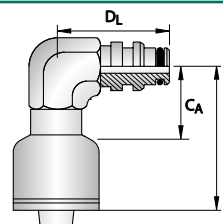

PART NO.	HOSE SIZE		THREAD SIZE	TUBE SIZE	DASH SIZE	DIMENSIONS						SPANNER			
	DN	inch				inch	mm	L		CA		DL		HF	HM
	DN	inch		mm		inch	mm	inch	mm	inch	mm		inch	mm	
T2872-0406	6	1/4		6	-0406	1.85	47	0.83	21	1.81	46			3/4	19
T2872-0410	6	1/4		10	-0410	1.89	48	0.87	22	1.81	46			7/8	22
T2872-0610	10	3/8		10	-0610	1.89	48	0.91	23	1.81	46			7/8	22
T2872-0812	12	1/2		12	-0812	2.13	54	1.15	29	1.99	51				
T2872-1016	16	5/8		16	-1016	2.28	58	1.11	28	2.07	53				
T2872-1220	19	3/4		20	-1220	2.36	60	1.19	30	2.19	56				
T2872-1625	25	1		25	-1625	2.81	71	1.60	41	2.68	68				
T2872-2032	31	1.1/4		32	-2032	3.65	93	1.68	43	2.68	68				
T2872-2440	38	1.1/2		40	-2440	4.45	113	2.40	61	3.35	85				
T2872-3250	51	2		50	-3250	4.80	122	2.60	66	3.94	100				
T2872-4063	63	2.1/2		63	-4063	6.18	157	3.15	80	5.51	140				

**RYCO WEO**

**T2480**

RYCO WEO MALE

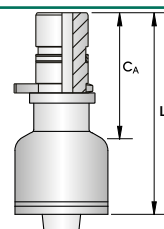

PART NO.	HOSE SIZE		THREAD SIZE	TUBE SIZE	DASH SIZE	DIMENSIONS						SPANNER			
	DN	inch				inch	mm	inch	mm	inch	mm	inch	mm	HF	HM
T2480-0304	5	3/16		1/4	-0304	1.97	50	1.22	31						
T2480-0404	6	1/4		1/4	-0404	2.20	56	1.22	31						
T2480-0406	6	1/4		3/8	-0406	2.36	60	1.38	35						
T2480-0506	8	5/16		3/8	-0506	2.36	60	1.38	35						
T2480-0606	10	3/8		3/8	-0606	2.36	60	1.38	35						
T2480-0608	10	3/8		1/2	-0608	2.36	60	1.38	35						
T2480-0808	12	1/2		1/2	-0808	2.36	60	1.42	36						
T2480-0812	12	1/2		3/4	-0812	2.80	71	1.85	47						
T2480-1012	16	5/8		3/4	-1012	2.95	75	1.73	44						
T2480-1212	19	3/4		3/4	-1212	2.95	75	1.77	45						
T2480-1616	25	1		1	-1616	3.43	87	2.20	56						

## T2000 SERIES ONE-PIECE CRIMP COUPLINGS

### RYCO WEO

### T2482

RYCO WEO MALE  
45° TUBE BEND

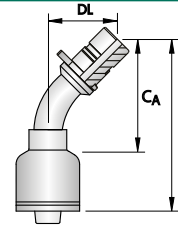

PART NO.	HOSE SIZE		THREAD SIZE	TUBE SIZE	DASH SIZE	DIMENSIONS						SPANNER	
	DN	inch				inch	inch	L		C <sub>A</sub>		D <sub>L</sub>	
	DN	inch		inch		inch	mm	inch	mm	inch	mm		
T2482-0404	6	1/4		1/4	-0404	2.72	69	1.73	44	0.98	25		
T2482-0506	8	5/16		3/8	-0506	3.11	79	2.13	54	1.06	27		
T2482-0606	10	3/8		3/8	-0606	3.15	80	2.17	55	1.06	27		
T2482-0808	12	1/2		1/2	-0808	3.31	84	2.32	59	1.22	31		
T2482-1012	16	5/8		3/4	-1012	4.02	102	2.83	72	1.57	40		
T2482-1212	19	3/4		3/4	-1212	4.41	112	3.23	82	1.69	43		
T2482-1616	25	1		1	-1616	5.35	136	4.13	105	2.09	53		

### RYCO WEO

### T2483

RYCO WEO MALE  
90° TUBE BEND

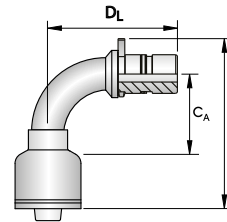

PART NO.	HOSE SIZE		THREAD SIZE	TUBE SIZE	DASH SIZE	DIMENSIONS						SPANNER	
	DN	inch				inch	inch	L		C <sub>A</sub>		D <sub>L</sub>	
	DN	inch		inch		inch	mm	inch	mm	inch	mm		
T2483-0404	6	1/4		1/4	-0404	2.13	54	1.14	29	1.57	40		
T2483-0506	8	5/16		3/8	-0506	2.36	60	1.38	35	2.05	52		
T2483-0606	10	3/8		3/8	-0606	2.36	60	1.38	35	2.05	52		
T2483-0608	10	3/8		1/2	-0608	2.40	61	1.42	36	1.85	47		
T2483-0808	12	1/2		1/2	-0808	2.48	63	1.50	38	2.28	58		
T2483-1012	16	5/8		3/4	-1012	3.31	84	2.13	54	3.23	82		
T2483-1212	19	3/4		3/4	-1212	3.31	84	2.13	54	3.23	82		
T2483-1616	25	1		1	-1616	4.06	103	2.83	72	3.82	97		

INTRODUCTION

INDEXES

ONE-PIECE  
COUPLINGS

PUSH-ON SUCTION &  
RETURN COUPLINGS

FIELD ATTACHABLE  
COUPLINGS

HYDRAULIC FITTINGS  
ACCESSORIES

# ONE-PIECE COUPLINGS

## T2000 SERIES ONE-PIECE CRIMP COUPLINGS

SAE

T2530

SAE MALE  
45° CONE

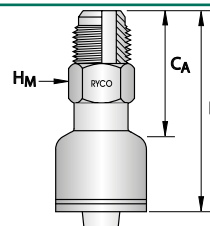

PART NO.	HOSE SIZE		THREAD SIZE	TUBE SIZE	DASH SIZE	DIMENSIONS				SPANNER					
	DN	inch	inch			L		C <sub>A</sub>		D <sub>L</sub>		H <sub>F</sub>		H <sub>M</sub>	
						inch	mm	inch	mm			inch	mm	inch	mm
T2530-0410	6	1/4	5/8" -18		-0410	2.20	56	1.22	31					11/16	
T2530-0608	10	3/8	1/2" -20		-0608	2.24	57	1.26	32					5/8	16
T2530-0610	10	3/8	5/8" -18		-0610	2.32	59	1.34	34					3/4	19

SAE

T2540

SAE FEMALE  
45° FLARE

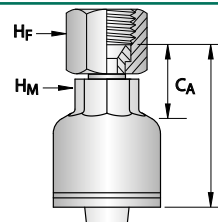

PART NO.	HOSE SIZE		THREAD SIZE	TUBE SIZE	DASH SIZE	DIMENSIONS				SPANNER					
	DN	inch	inch			L		C <sub>A</sub>		D <sub>L</sub>		H <sub>F</sub>		H <sub>M</sub>	
						inch	mm	inch	mm			inch	mm	inch	mm
T2540-0407	6	1/4	7/16" -20		-0407	1.77	45	0.75	19			9/16		1/2	
T2540-0410	6	1/4	5/8" -18		-0410	1.89	48	0.91	23			3/4	19	5/8	16
T2540-0608	10	3/8	1/2" -20		-0608	1.77	45	0.79	20			5/8	16	5/8	16
T2540-0610	10	3/8	5/8" -18		-0610	1.89	48	0.91	23			3/4	19	5/8	16
T2540-1217	19	3/4	1.1/16" -12		-1217	2.20	56	1.06	27			1.1/4	32	1	

## T2000 SERIES ONE-PIECE CRIMP COUPLINGS

SAE

T2580

SAE FEMALE  
45° FLARE  
45° ELBOW

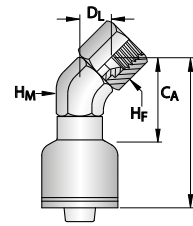

PART NO.	HOSE SIZE		THREAD SIZE	TUBE SIZE	DASH SIZE	DIMENSIONS						SPANNER			
	DN	inch	inch			L		CA		DL		HF		HM	
	DN	inch	inch			inch	mm	inch	mm	inch	mm	inch	mm	inch	mm
T2580-0608	10	3/8	1/2" -20		-0608	2.20	56	1.26	32	0.55	14	5/8	16	3/4	19
T2580-0610	10	3/8	5/8" -18		-0610	2.24	57	1.26	32	0.59	15	3/4	19	3/4	19

SAE

T2570

SAE  
FEMALE  
45° FLARE  
90° ELBOW

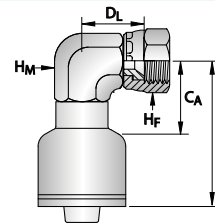

PART NO.	HOSE SIZE		THREAD SIZE	TUBE SIZE	DASH SIZE	DIMENSIONS						SPANNER			
	DN	inch	inch			L		CA		DL		HF		HM	
	DN	inch	inch			inch	mm	inch	mm	inch	mm	inch	mm	inch	mm
T2570-0608	10	3/8	1/2" -20		-0608	1.89	48	0.91	23	0.87	22	5/8	16	3/4	19
T2570-0610	10	3/8	5/8" -18		-0610	1.89	48	0.91	23	0.91	23	3/4	19	3/4	19

SAE

T2740

SAE INVERTED MALE FLARE

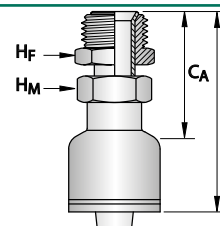

PART NO.	HOSE SIZE		THREAD SIZE	TUBE SIZE	DASH SIZE	DIMENSIONS						SPANNER			
	DN	inch	inch	inch		L		CA		DL		HF		HM	
	DN	inch	inch	inch		inch	mm	inch	mm	inch	mm	inch	mm	inch	mm
T2740-0407	6	1/4	7/16" -20	1/4	-0407	2.60	66	1.57	40			7/16	11	1/2	
T2740-0610	10	3/8	5/8" -18	3/8	-0610	2.60	66	1.61	41			5/8	16	5/8	16
T2740-0611	10	3/8	11/16" -16	7/16	-0611	2.68	68	1.73	44			11/16		5/8	16
T2750-0610	10	3/8	5/8" -18	3/8	-0610	3.86	98	2.87	73	0.91	23	5/8	16	5/8	16
T2760-0407	6	1/4	7/16" -20	1/4	-0407	3.46	88	2.48	63	1.14	29	7/16	11	1/2	
T2770-0407	6	1/4	7/16" -20	1/4	-0407	2.72	69	1.73	44	1.50	38	7/16	11	1/2	
T2770-0610	10	3/8	5/8" -18	3/8	-0610	3.15	80	2.17	55	1.97	50	5/8	16	5/8	16
T2780-0610	10	3/8	5/8" -18	3/8	-0610	1.89	48	0.91	23	1.26	32	5/8	16	3/4	19
T2780-0611	10	3/8	11/16" -16	7/16	-0611	1.69	43	0.71	18	1.42	36	11/16		3/4	19
T2790-0610	10	3/8	5/8" -18	3/8	-0610	1.69	43	0.71	18	2.36	60	5/8	16	3/4	19

# ONE-PIECE COUPLINGS

## T2000 SERIES ONE-PIECE CRIMP COUPLINGS

SAE

T2780

SAE INVERTED MALE FLARE  
90° ELBOW

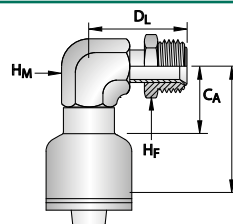

PART NO.	HOSE SIZE		THREAD SIZE	TUBE SIZE	DASH SIZE	DIMENSIONS						SPANNER			
	DN	inch	inch	inch		L		C <sub>A</sub>		D <sub>L</sub>		H <sub>F</sub>		H <sub>M</sub>	
T2780-0610	10	3/8	5/8" -18	3/8	-0610	1.89	48	0.91	23	1.26	32	5/8	16	3/4	19
T2780-0611	10	3/8	11/16" -16	7/16	-0611	1.69	43	0.71	18	1.42	36	11/16		3/4	19

SAE

T2790

SAE INVERTED MALE FLARE  
90° LONG ELBOW

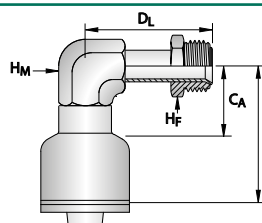

PART NO.	HOSE SIZE		THREAD SIZE	TUBE SIZE	DASH SIZE	DIMENSIONS						SPANNER			
	DN	inch	inch	inch		L		C <sub>A</sub>		D <sub>L</sub>		H <sub>F</sub>		H <sub>M</sub>	
T2790-0610	10	3/8	5/8" -18	3/8	-0610	1.69	43	0.71	18	2.36	60	5/8	16	3/4	19

SAE

T2750

SAE INVERTED MALE FLARE  
45° TUBE BEND

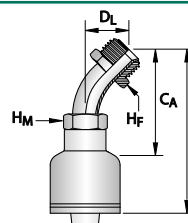

PART NO.	HOSE SIZE		THREAD SIZE	TUBE SIZE	DASH SIZE	DIMENSIONS						SPANNER			
	DN	inch	inch	inch		L		C <sub>A</sub>		D <sub>L</sub>		H <sub>F</sub>		H <sub>M</sub>	
T2750-0610	10	3/8	5/8" -18	3/8	-0610	3.86	98	2.87	73	0.91	23			5/8	16

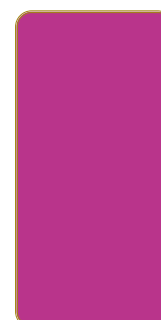

## T2000 SERIES ONE-PIECE CRIMP COUPLINGS

### SAE T2760

SAE INVERTED MALE FLARE  
60° TUBE BEND

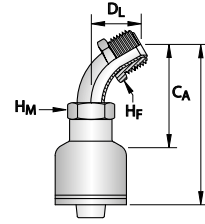

PART NO.	HOSE SIZE		THREAD SIZE	TUBE SIZE	DASH SIZE	DIMENSIONS						SPANNER			
	DN	inch	inch	inch		L		C <sub>A</sub>		D <sub>L</sub>		H <sub>F</sub>		H <sub>M</sub>	
						inch	mm	inch	mm	inch	mm			inch	mm
<b>T2760-0407</b>	6	1/4	7/16" - 20	1/4	-0407	3.46	88	2.48	63	1.14	29			1/2	

### SAE T2770

SAE INVERTED MALE FLARE  
90° TUBE BEND

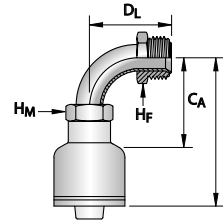

PART NO.	HOSE SIZE		THREAD SIZE	TUBE SIZE	DASH SIZE	DIMENSIONS						SPANNER			
	DN	inch	inch	inch		L		C <sub>A</sub>		D <sub>L</sub>		H <sub>F</sub>		H <sub>M</sub>	
						inch	mm	inch	mm	inch	mm			inch	mm
<b>T2770-0407</b>	6	1/4	7/16" - 20	1/4	-0407	2.72	69	1.73	44	1.50	38			1/2	
<b>T2770-0610</b>	10	3/8	5/8" - 18	3/8	-0610	3.15	80	2.17	55	1.97	50			5/8	16

INTRODUCTION

INDEXES

ONE-PIECE  
COUPLINGS

PUSH-ON SUCTION &  
RETURN COUPLINGS

FIELD ATTACHABLE  
COUPLINGS

HYDRAULIC FITTINGS  
ACCESSORIES

# ONE-PIECE COUPLINGS

## T2000 SERIES ONE-PIECE CRIMP COUPLINGS

### DIMENSIONS FOR SAE CODE 61 AND CODE 62 FLANGES, AND RYCO CODE 62C FLANGES

NOMINAL FLANGE	CODE 61				CODE 62				CODE 62C			
	B		T		B		T		B		T	
inch	mm	inch	mm	inch	mm	inch	mm	inch	mm	inch	mm	inch
1/2	30,2	1.19	6,73	0.265	31,8	1.25	7,75	0.305				
5/8	34,0	1.34	6,73	0.265								
3/4	38,1	1.50	6,73	0.265	41,3	1.63	8,76	0.345	41,3	1.63	14,20	0.559
1	44,5	1.75	8,00	0.315	47,6	1.88	9,53	0.375	47,6	1.88	14,20	0.559
1.1/4	50,8	2.00	8,00	0.315	54,0	2.12	10,29	0.405	54,0	2.12	14,20	0.559
1.1/2	60,3	2.38	8,00	0.315	63,5	2.50	12,57	0.495	63,5	2.50	14,20	0.559
2	71,4	2.81	9,53	0.375	79,4	3.13	12,57	0.495	79,4	3.13	14,20	0.559
2.1/2	84,1	3.31	9,53	0.375								
3	101,6	4.00	9,53	0.375								

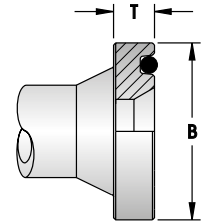

**NOTE:** Ryco Code 62C fittings conform to the flange OD and bolt hole patterns of SAE Code 62 but require special flange clamps. Ryco Code 62C flange heads are thicker than SAE Code 62 and measure T = 14,2 mm (0.559 inch) in all sizes.

### SAE FLANGE

### T2130

#### SAE CODE 61 FLANGE

RYCO CODE 61 CLAMPS  
SEE PAGES 442 & 443  
O RING NOT SUPPLIED

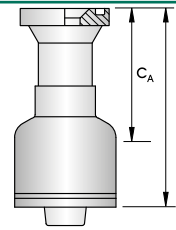

PART NO.	HOSE SIZE		THREAD SIZE	TUBE SIZE	DASH SIZE	DIMENSIONS				SPANNER			
	DN	inch				L		C <sub>A</sub>		D <sub>L</sub>		H <sub>F</sub>	
						inch	mm	inch	mm				
T2130-0808	12	1/2			-0808	2.72	69	1.77	45				
T2130-0812	12	1/2			-0812	2.83	72	1.89	48				
T2130-1010	16	5/8			-1010	2.95	75	1.73	44				
T2130-1210	19	3/4			-1210	2.95	75	1.77	45				
T2130-1212	19	3/4			-1212	2.99	76	1.81	46				
T2130-1216	19	3/4			-1216	3.15	80	1.97	50				
T2130-1612	25	1			-1612	3.11	79	1.89	48				
T2130-1616	25	1			-1616	3.27	83	2.05	52				
T2130-1620	25	1			-1620	3.46	88	2.24	57				
T2130-1624	25	1			-1624	4.53	115	3.31	84				
T2130-2016	31	1.1/4			-2016	4.09	104	2.13	54				
T2130-2020	31	1.1/4			-2020	4.29	109	2.32	59				
T2130-2024	31	1.1/4			-2024	5.28	134	3.35	85				
T2130-2424	38	1.1/2			-2424	5.39	137	3.39	86				
T2130-2432	38	1.1/2			-2432	5.79	147	3.78	96				
T2130-3232	51	2			-3232	5.98	152	3.78	96				
T2130-3240	51	2			-3240	6.18	157	3.98	101				
T2130-4040	63	2.1/2			-4040	6.14	156	3.11	79				
T2130-4848	76	3			-4848	6.14	156	3.15	80				

## T2000 SERIES ONE-PIECE CRIMP COUPLINGS

### SAE FLANGE

### T2150

SAE CODE 61 FLANGE  
45° TUBE BEND

RYCO CODE 61 CLAMPS  
SEE PAGES 442 & 443  
O RING NOT SUPPLIED

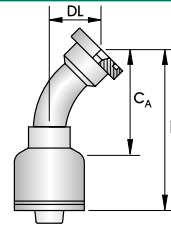

PART NO.	HOSE SIZE		THREAD SIZE	TUBE SIZE	DASH SIZE	DIMENSIONS						SPANNER	
	DN	inch				L		C <sub>A</sub>		D <sub>L</sub>		H <sub>F</sub>	H <sub>M</sub>
						inch	mm	inch	mm	inch	mm		
<b>T2150-0808</b>	12	1/2			-0808	2.91	74	1.93	49	0.79	20		
<b>T2150-0812</b>	12	1/2			-0812	2.95	75	2.01	51	0.94	24		
<b>T2150-1010</b>	16	5/8			-1010	3.39	86	2.20	56	0.94	24		
<b>T2150-1210</b>	19	3/4			-1210	3.50	89	2.32	59	1.02	26		
<b>T2150-1212</b>	19	3/4			-1212	3.74	95	2.56	65	1.02	26		
<b>T2150-1216</b>	19	3/4			-1216	3.86	98	2.68	68	1.18	30		
<b>T2150-1612</b>	25	1			-1612	2.68	68	1.46	37	1.02	26		
<b>T2150-1616</b>	25	1			-1616	4.41	112	3.19	81	1.18	30		
<b>T2150-1620</b>	25	1			-1620	4.49	114	3.27	83	1.26	32		
<b>T2150-1624</b>	25	1			-1624	4.49	114	3.27	83	1.57	40		
<b>T2150-2016</b>	31	1.1/4			-2016	5.43	138	3.46	88	1.18	30		
<b>T2150-2020</b>	31	1.1/4			-2020	5.91	150	3.94	100	1.42	36		
<b>T2150-2024</b>	31	1.1/4			-2024	6.02	153	4.06	103	1.57	40		
<b>T2150-2424</b>	38	1.1/2			-2424	6.38	162	4.33	110	1.65	42		
<b>T2150-3232</b>	51	2			-3232	8.11	206	5.91	150	2.28	58		

INTRODUCTION

INDEXES

ONE-PIECE  
COUPLINGS

PUSH-ON SUCTION &  
RETURN COUPLINGS

FIELD ATTACHABLE  
COUPLINGS

HYDRAULIC FITTINGS  
ACCESSORIES

# ONE-PIECE COUPLINGS

## T2000 SERIES ONE-PIECE CRIMP COUPLINGS

### SAE FLANGE

### T2170

SAE CODE 61 FLANGE  
90° TUBE BEND

RYCO CODE 61 CLAMPS  
SEE PAGES 442 & 443  
O RING NOT SUPPLIED

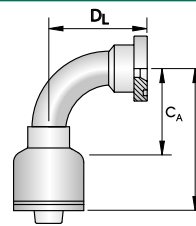

PART NO.	HOSE SIZE		THREAD SIZE	TUBE SIZE	DASH SIZE	DIMENSIONS						SPANNER	
	DN	inch				L		CA		DL		HF	HM
						inch	mm	inch	mm	inch	mm		
T2170-0808	12	1/2			-0808	2.56	65	1.57	40	1.61	41		
T2170-0812	12	1/2			-0812	2.56	65	1.57	40	1.81	46		
T2170-1010	16	5/8			-1010	3.07	78	1.89	48	1.89	48		
T2170-1212	19	3/4			-1212	3.35	85	2.17	55	2.13	54		
T2170-1216	19	3/4			-1216	3.35	85	2.17	55	2.36	60		
T2170-1612	25	1			-1612	3.54	90	2.36	60	2.13	54		
T2170-1616	25	1			-1616	3.90	99	2.68	68	2.68	68		
T2170-1620	25	1			-1620	3.98	101	2.76	70	2.72	69		
T2170-2016	31	1.1/4			-2016	5.04	128	3.07	78	2.68	68		
T2170-2020	31	1.1/4			-2020	5.12	130	3.15	80	3.07	78		
T2170-2024	31	1.1/4			-2024	5.51	140	3.54	90	3.19	81		
T2170-2424	38	1.1/2			-2424	6.14	156	4.09	104	3.66	93		
T2170-3232	51	2			-3232	7.60	193	5.39	137	5.12	130		
T2170-3240	51	2			-3240	7.76	197	5.55	141	5.28	134		

### SALVAGE

### T2230

SALVAGE (LIFESAVER)  
TUBE WELD

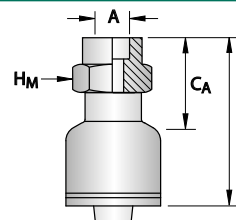

PART NO.	HOSE SIZE		THREAD SIZE	TUBE SIZE	DASH SIZE	DIMENSIONS						SPANNER		
	DN	inch				L		CA		DL		HF	HM	
				inch		inch	mm	inch	mm			inch	mm	
T2230-0404	6	1/4		1/4	-0404	1.73	44	0.71	18				1/2	
T2230-0405	6	1/4		5/16	-0405	1.73	44	0.71	18				1/2	
T2230-0406	6	1/4		3/8	-0406	1.73	44	0.71	18				9/16	
T2230-0505	8	5/16		5/16	-0505	1.69	43	0.71	18				9/16	
T2230-0606	10	3/8		3/8	-0606	1.69	43	0.71	18				5/8	16
T2230-0608	10	3/8		1/2	-0608	1.69	43	0.71	18				11/16	
T2230-0808	12	1/2		1/2	-0808	1.73	44	0.75	19				11/16	
T2230-0810	12	1/2		5/8	-0810	1.77	45	0.83	21				7/8	22
T2230-1010	16	5/8		5/8	-1010	2.01	51	0.79	20				1	
T2230-1012	16	5/8		3/4	-1012	2.01	51	0.79	20				1.1/16	27
T2230-1212	19	3/4		3/4	-1212	2.01	51	0.83	21				1	
T2230-1616	25	1		1	-1616	2.28	58	1.10	28				1.3/8	35
T2230-2020	31	1.1/4		1.1/4	-2020	3.19	81	1.22	31				1.3/4	
T2230-2424	38	1.1/2		1.1/2	-2424	3.39	86	1.34	34				2	50
T2230-3232	51	2		2	-3232	3.86	98	1.61	41				2.1/2	

## T2000 SERIES ONE-PIECE CRIMP COUPLINGS

**STANDPIPE**

**T2180**

IMPERIAL STANDPIPE

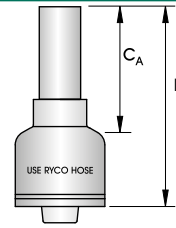

PART NO.	HOSE SIZE		THREAD SIZE	TUBE SIZE	DASH SIZE	DIMENSIONS				SPANNER					
	DN	inch				inch	inch	L		C <sub>A</sub>		D <sub>L</sub>		H <sub>F</sub>	
						inch	mm	inch	mm	inch	mm	inch	mm	inch	mm
<b>T2180-0406</b>	6	1/4		3/8	-0406	2.24	57	1.26	32						
<b>T2180-0606</b>	10	3/8		3/8	-0606	2.24	57	1.26	32						
<b>T2180-0808</b>	12	1/2		1/2	-0808	2.24	57	1.30	33						
<b>T2180-0810</b>	12	1/2		5/8	-0810	2.52	64	1.57	40						
<b>T2180-1212</b>	19	3/4		3/4	-1212	2.99	76	1.81	46						
<b>T2180-1616</b>	25	1		1	-1616	3.23	82	2.05	52						

INTRODUCTION

INDEXES

ONE-PIECE  
COUPLINGS

PUSH-ON SUCTION &  
RETURN COUPLINGS

FIELD ATTACHABLE  
COUPLINGS

HYDRAULIC FITTINGS  
ACCESSORIES

# ONE-PIECE COUPLINGS

## T2000 SERIES ONE-PIECE CRIMP COUPLINGS

STANDPIPE

T2640

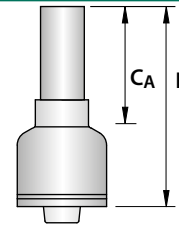

METRIC STANDPIPE

PART NO.	HOSE SIZE		THREAD SIZE	TUBE SIZE	DASH SIZE	DIMENSIONS				SPANNER							
	DN	inch				inch	mm	L		C <sub>A</sub>		D <sub>L</sub>		H <sub>F</sub>		H <sub>M</sub>	
T2640-0306	5	3/16		6	-0306	1.97	50	1.22	31								
T2640-0406	6	1/4		6	-0406	2.20	56	1.22	31								
T2640-0408	6	1/4		8	-0408	2.20	56	1.22	31								
T2640-0410	6	1/4		10	-0410	2.24	57	1.26	32								
T2640-0412	6	1/4		12	-0412	2.24	57	1.26	32								
T2640-0510	8	5/16		10	-0510	2.24	57	1.26	32								
T2640-0512	8	5/16		12	-0512	2.24	57	1.26	32								
T2640-0610	10	3/8		10	-0610	2.24	57	1.26	32								
T2640-0612	10	3/8		12	-0612	2.24	57	1.26	32								
T2640-0614	10	3/8		14	-0614	2.48	63	1.50	38								
T2640-0812	12	1/2		12	-0812	2.24	57	1.26	32								
T2640-0814	12	1/2		14	-0814	2.48	63	1.54	39								
T2640-0815	12	1/2		15	-0815	2.32	59	1.38	35								
T2640-0816	12	1/2		16	-0816	2.52	64	1.57	40								
T2640-1016	16	5/8		16	-1016	2.72	69	1.54	39								
T2640-1018	16	5/8		18	-1018	2.56	65	1.38	35								
T2640-1020	16	5/8		20	-1020	2.95	75	1.77	45								
T2640-1022	16	5/8		22	-1022	2.64	67	1.46	37								
T2640-1215	19	3/4		15	-1215	2.56	65	1.38	35								
T2640-1220	19	3/4		20	-1220	2.99	76	1.81	46								
T2640-1222	19	3/4		22	-1222	2.68	68	1.50	38								
T2640-1225	19	3/4		25	-1225	2.99	76	1.81	46								
T2640-1625	25	1		25	-1625	3.15	80	1.93	49								
T2640-1628	25	1		28	-1628	3.15	80	1.93	49								
T2640-1630	25	1		30	-1630	3.46	88	2.24	57								

## T2000 SERIES ONE-PIECE CRIMP COUPLINGS

### STANDPIPE

### T2643

METRIC STANDPIPE  
45° TUBE BEND

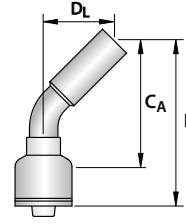

PART NO.	HOSE SIZE		THREAD SIZE	TUBE SIZE	DASH SIZE	DIMENSIONS						SPANNER	
	DN	inch				inch	mm	L		C <sub>A</sub>		D <sub>L</sub>	
						inch	mm	inch	mm	inch	mm		
T2643-0406	6	1/4		6	-0406	2.64	67	1.65	42	0.81	21		
T2643-0408	6	1/4		8	-0408	2.68	68	1.69	43	0.87	22		
T2643-0410	6	1/4		10	-0410	2.64	67	1.65	42	0.94	24		
T2643-0610	10	3/8		10	-0610	2.76	70	1.77	45	0.91	23		
T2643-0612	10	3/8		12	-0612	2.83	72	1.85	47	0.98	25		
T2643-0614	10	3/8		14	-0614	2.99	76	2.01	51	1.14	29		
T2643-0815	12	1/2		15	-0815	3.27	83	2.28	58	1.10	28		
T2643-0816	12	1/2		16	-0816	3.35	85	2.36	60	1.18	30		
T2643-1018	16	5/8		18	-1018	3.66	93	2.48	63	1.20	31		
T2643-1020	16	5/8		20	-1020	3.86	98	2.68	68	1.42	36		
T2643-1222	19	3/4		22	-1222	3.92	100	2.76	70	1.26	32		
T2643-1225	19	3/4		25	-1225	4.27	109	3.11	79	1.59	41		
T2643-1628	25	1		28	-1628	4.65	118	3.43	87	1.46	37		

### STANDPIPE

### T2646

METRIC STANDPIPE  
90° TUBE BEND

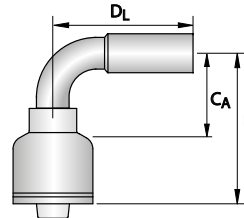

PART NO.	HOSE SIZE		THREAD SIZE	TUBE SIZE	DASH SIZE	DIMENSIONS						SPANNER	
	DN	inch				inch	mm	L		C <sub>A</sub>		D <sub>L</sub>	
						inch	mm	inch	mm	inch	mm		
T2646-0406	6	1/4		6	-0406	-	-	-	-	-	-		
T2646-0408	6	1/4		8	-0408	2.05	52	1.06	27	1.50	38		
T2646-0410	6	1/4		10	-0410	2.05	52	1.06	27	1.61	41		
T2646-0412	6	1/4		12	-0412	2.05	52	1.06	27	1.73	44		
T2646-0610	10	3/8		10	-0610	2.36	60	1.38	35	1.69	43		
T2646-0612	10	3/8		12	-0612	2.36	60	1.38	35	1.77	45		
T2646-0614	10	3/8		14	-0614	2.36	60	1.38	35	2.01	51		
T2646-0812	12	1/2		12	-0812	2.56	65	1.57	40	1.77	45		
T2646-0814	12	1/2		14	-0814	2.56	65	1.57	40	2.01	51		
T2646-0816	16	5/8		16	-0816	2.56	65	1.57	40	2.17	55		
T2646-1018	16	5/8		18	-1018	3.07	78	1.89	48	2.32	59		
T2646-1022	16	5/8		22	-1022	2.68	68	1.89	48	2.48	63		
T2646-1220	19	3/4		20	-1220	3.35	85	2.17	55	2.72	69		
T2646-1222	19	3/4		22	-1222	3.35	85	2.17	55	2.48	63		
T2646-1225	19	3/4		25	-1225	3.35	85	2.17	55	2.95	75		
T2646-1625	25	1		25	-1625	4.06	103	2.83	72	3.03	77		
T2646-1630	25	1		30	-1630	4.06	103	2.83	72	2.64	67		

# ONE-PIECE COUPLINGS

## T2000 SERIES ONE-PIECE CRIMP COUPLINGS

### TUBE BITE

### T2850

#### TUBE BITE

COMPLETE WITH NUT  
AND FLARELESS OLIVE

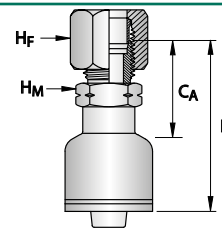

PART NO.	HOSE SIZE		THREAD SIZE	TUBE SIZE	DASH SIZE	DIMENSIONS				SPANNER					
	DN	inch	inch	inch		L		C <sub>A</sub>		D <sub>L</sub>		H <sub>F</sub>		H <sub>M</sub>	
						inch	mm	inch	mm			inch	mm	inch	mm
T2850-0404	6	1/4	7/16"-20	1/4	-0404	2.05	52	1.06	27			9/16		1/2	
T2850-0405	6	1/4	1/2"-20	5/16	-0405	2.05	52	1.06	27			5/8	16	9/16	
T2850-0505	8	5/16	1/2"-20	5/16	-0505	2.05	52	1.06	27			5/8	16		
T2850-0605	10	3/8	1/2"-20	5/16	-0605	2.13	54	1.14	29			5/8	16	9/16	
T2850-0606	10	3/8	9/16"-18	3/8	-0606	2.17	55	1.18	30			11/16		5/8	16
T2850-0608	10	3/8	3/4"-16	1/2	-0608	2.24	57	1.26	32			7/8	22	13/16	
T2850-0808	12	1/2	3/4"-16	1/2	-0808	2.32	59	1.38	35			7/8	22	13/16	
T2850-0810	12	1/2	7/8"-14	5/8	-0810	2.40	61	1.42	36			1		15/16	24
T2850-1212	19	3/4	1.1/16"-12	3/4	-1212	2.72	69	1.54	39			1.1/4	32	1.1/8	
T2850-1616	25	1	1.5/16"-12	1	-1616	2.83	72	1.61	41			1.1/2	38	1.3/8	35

### UNO (O RING BOSS)

### T2200

#### UN O RING MALE

O RING SUPPLIED

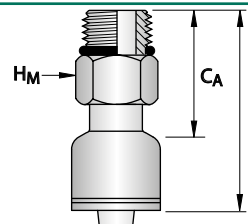

PART NO.	HOSE SIZE		THREAD SIZE	TUBE SIZE	DASH SIZE	DIMENSIONS				SPANNER					
	DN	inch	inch			L		C <sub>A</sub>		D <sub>L</sub>		H <sub>F</sub>		H <sub>M</sub>	
						inch	mm	inch	mm					inch	mm
T2200-0407	6	1/4	7/16" -20		-0407	1.97	50	0.98	25					9/16	
T2200-0408	6	1/4	1/2" - 20		-0408	1.97	50	0.98	25					5/8	16
T2200-0409	6	1/4	9/16" -18		-0409	2.01	51	0.98	25					11/16	
T2200-0609	10	3/8	9/16" -18		-0609	2.09	53	1.10	28					11/16	
T2200-0612	10	3/8	3/4" -16		-0612	2.13	54	1.14	29					7/8	22
T2200-0614	10	3/8	7/8" -14		-0614	2.09	53	1.10	28					1	
T2200-0812	12	1/2	3/4" -14		-0812	2.20	56	1.22	31					7/8	22
T2200-0814	12	1/2	7/8" -14		-0814	2.24	57	1.30	33					1	
T2200-0817	12	1/2	1.1/16" -12		-0817	2.24	57	1.26	32					1.1/4	32
T2200-1014	16	5/8	7/8" -14		-1014	2.52	64	1.34	34					1	
T2200-1017	16	5/8	1.1/16" -12		-1017	2.44	62	1.26	32					1.1/4	32
T2200-1217	19	3/4	1.1/16" -12		-1217	2.64	67	1.46	37					1.1/4	32
T2200-1221	19	3/4	1.5/16" -12		-1221	2.52	64	1.38	35					1.1/2	38
T2200-1621	25	1	1.5/16" -12		-1621	2.72	69	1.54	39					1.1/2	38
T2200-2026	31	1.1/4	1.5/8" -12		-2026	3.66	93	1.69	43					2	50

## T2000 SERIES ONE-PIECE CRIMP COUPLINGS

**UNO**

**T2380**

UN O RING  
MALE SWIVEL

O RING SUPPLIED

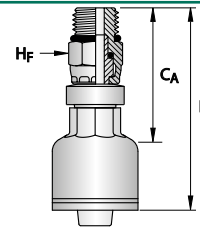

PART NO.	HOSE SIZE		THREAD SIZE	TUBE SIZE	DASH SIZE	DIMENSIONS						SPANNER			
	DN	inch	inch			L		C <sub>A</sub>		D <sub>L</sub>		H <sub>F</sub>		H <sub>M</sub>	
						inch	mm	inch	mm			inch	mm		
<b>T2380-0609</b>	10	3/8	9/16" -18		-0609	2.13	54	1.14	29			11/16			
<b>T2380-0612</b>	10	3/8	3/4" -16		-0612	2.32	59	1.34	34			7/8	22		
<b>T2380-0812</b>	12	1/2	3/4" -16		-0812	2.32	59	1.38	35			7/8	22		
<b>T2380-0814</b>	12	1/2	7/8" -14		-0814	2.32	59	1.38	35			1			
<b>T2380-0817</b>	12	1/2	1.1/16" -12		-0817	2.40	61	1.42	36			1.1/4	32		
<b>T2380-1014</b>	16	5/8	7/8" -14		-1014	2.48	63	1.30	33			1			
<b>T2380-1217</b>	19	3/4	1.1/16" -12		-1217	2.60	66	1.46	37			1.1/4	32		

**UNO**

**T2390**

UN O RING (BOSS) MALE SWIVEL  
90° ELBOW

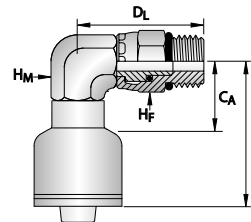

PART NO.	HOSE SIZE		THREAD SIZE	TUBE SIZE	DASH SIZE	DIMENSIONS						SPANNER			
	DN	inch	inch			L		C <sub>A</sub>		D <sub>L</sub>		H <sub>F</sub>		H <sub>M</sub>	
						inch	mm	inch	mm	inch	mm	inch	mm	inch	mm
<b>T2390-0609</b>	10	3/8	9/16" -18		-0609	1.89	48	0.91	23	1.46	37	11/16		3/4	19
<b>T2390-0612</b>	10	3/8	3/4" -16		-0612	1.89	48	0.91	23	1.65	42	7/8	22	3/4	19
<b>T2390-0614</b>	10	3/8	7/8" -14		-0614	1.89	48	0.91	23	1.69	43	1		3/4	19
<b>T2390-0812</b>	12	1/2	3/4" -14		-0812	2.13	54	1.14	29	1.73	44	7/8	22	7/8	22
<b>T2390-0814</b>	12	1/2	7/8" -14		-0814	2.13	54	1.14	29	1.77	45	1		7/8	22
<b>T2390-1217</b>	19	3/4	1.1/16" -12		-1217	2.36	60	1.18	30	2.01	51	1.1/4	32	1.1/16	27

INTRODUCTION

INDEXES

ONE-PIECE COUPLINGS

PUSH-ON SUCTION & RETURN COUPLINGS

FIELD ATTACHABLE COUPLINGS

HYDRAULIC FITTINGS ACCESSORIES

# ONE-PIECE COUPLINGS

## T4000 SERIES ONE-PIECE CRIMP COUPLINGS

### HOSE COMPATIBILITY FOR T4000 SERIES

#### NON-SKIVE

For Ryco Hose Series SRF/P, SRX/HT (sizes -12 to -48).  
 For Ryco Hose Series RT7/T/7N/7TN (sizes -02 to -12).  
 For Ryco Hose Series T5, SURVIVOR/R5 (sizes -04 to -32).  
 For Ryco Hose Series MP1 (sizes -04 to -20).  
 For Ryco Hose Series RST (sizes -08 to -48).  
 For Ryco Hose Series PCM (sizes -08 to -16).  
 For Ryco Hose Series M2/G, PL1D (sizes -04 to -12).

#### NON-SKIVE

For Ryco Hose Series TP7, TP7N, TP7T, TP7TN, TP3000, PL1D, PL1PV, , CS1000, MS1000.

### BSPT

### T4010

BSPT MALE  
60° SEAT

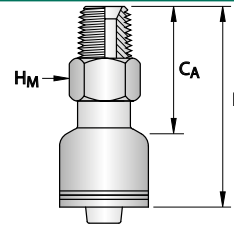

PART NO.	HOSE SIZE		THREAD SIZE	TUBE SIZE	DASH SIZE	DIMENSIONS				SPANNER			
	DN	inch	inch			L		CA		DL	HF	HM	
						inch	mm	inch	mm			inch	mm
T4010-0304	5	3/16	1/4" -19		-0304	1.97	50	1.18	30			9/16	
T4010-0404	6	1/4	1/4" -19		-0404	2.17	55	1.18	30			9/16	
T4010-0504	8	5/16	1/4" -19		-0504	2.17	55	1.18	30			9/16	
T4010-0604	10	3/8	1/4" -19		-0604	2.20	56	1.30	33			5/8	16
T4010-0606	10	3/8	3/8" -19		-0606	2.20	56	1.30	33			11/16	
T4010-0608	10	3/8	1/2" -14		-0608	2.40	61	1.46	37			7/8	22
T4010-0806	12	1/2	3/8" -19		-0806	2.36	60	1.38	35			11/16	
T4010-0808	12	1/2	1/2" -14		-0808	2.56	65	1.57	40			7/8	22
T4010-1012	16	5/8	3/4" -14		-1012	2.83	72	1.61	41			1.1/16	27
T4010-1212	19	3/4	3/4" -14		-1212	2.83	72	1.61	41			1.1/16	27
T4010-1616	25	1	1" -11		-1616	3.19	81	1.89	48			1.3/8	35
T4010-2020	31	1.1/4	1.1/4" -11		-2020	3.90	99	2.09	53			1.3/4	
T4010-2424	38	1.1/2	1.1/2" -11		-2424	4.13	105	2.17	55			2	50
T4010-3232	51	2	2" -11		-3232	4.69	119	2.60	66			2.1/2	

### BSPP

### T4013

BSPP MALE  
60° SEAT

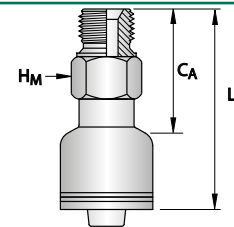

PART NO.	HOSE SIZE		THREAD SIZE	TUBE SIZE	DASH SIZE	DIMENSIONS				SPANNER			
	DN	inch	inch			L		CA		DL	HF	HM	
						inch	mm	inch	mm			inch	mm
T4013-0404	6	1/4	1/4" -19		-0404	2.09	53	1.10	28			3/4	19
T4013-0606	10	3/8	3/8" -19		-0606	2.09	53	1.14	29			7/8	22
T4013-0808	12	1/2	1/2" -14		-0808	2.32	59	1.34	34			1.1/16	27
T4013-1212	19	3/4	3/4" -14		-1212	2.76	70	1.54	39			1.1/4	32
T4013-1616	25	1	1" -11		-1616	3.07	78	1.77	45			1.5/8	41
T4013-2020	31	1.1/4	1.1/4" -11		-2020	3.86	98	2.01	51			2	50

## T4000 SERIES ONE-PIECE CRIMP COUPLINGS

### BSPT

### T4320

BSPT MALE SWIVEL  
60° SEAT

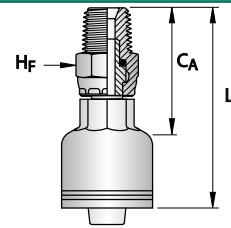

PART NO.	HOSE SIZE		THREAD SIZE	TUBE SIZE	DASH SIZE	DIMENSIONS						SPANNER			
	DN	inch	inch	inch		L		C <sub>A</sub>		D <sub>L</sub>		H <sub>F</sub>		H <sub>M</sub>	
T4320-0202	4	1/8	3/4		-0202	1.89	48	1.34	34			1/2			

### BSPP

### T4020

BSPP FEMALE  
60° CONE

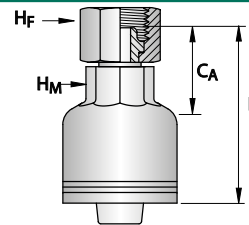

PART NO.	HOSE SIZE		THREAD SIZE	TUBE SIZE	DASH SIZE	DIMENSIONS						SPANNER			
	DN	inch	inch			L		C <sub>A</sub>		D <sub>L</sub>		H <sub>F</sub>		H <sub>M</sub>	
T4020-0304	5	3/16	1/4" -19		-0304	1.61	41	0.87	22			3/4	19	1/2	
T4020-0404	6	1/4	1/4" -19		-0404	1.93	49	0.94	24			3/4	19	1/2	
T4020-0504	8	5/16	1/4" -19		-0504	1.85	47	0.87	22			3/4	19	9/16	
T4020-0604	10	3/8	1/4" -19		-0604	1.81	46	0.87	22			3/4	19	9/16	
T4020-0606	10	3/8	3/8" -19		-0606	2.01	51	1.06	27			7/8	22	5/8	16
T4020-0608	10	3/8	1/2" -14		-0608	2.05	52	1.10	28			1.1/16	27	3/4	19
T4020-0808	12	1/2	1/2" -14		-0808	2.13	54	1.14	29			1.1/16	27	3/4	19
T4020-0812	12	1/2	3/4" -14		-0812	2.17	55	1.18	30			1.1/4	32	1	
T4020-1010	16	5/8	5/8" -14		-1010	2.36	60	1.14	29			1.3/16	30	7/8	22
T4020-1012	16	5/8	3/4" -14		-1012	2.32	59	1.06	27			1.1/4	32	1	
T4020-1212	19	3/4	3/4" -14		-1212	2.48	61	1.30	31			1.1/4	32	1.1/16	27
T4020-1616	25	1	1" -11		-1616	2.80	71	1.46	36			1.1/2	38	1.1/4	32
T4020-2020	31	1.1/4	1.1/4" -11		-2020	3.70	94	1.77	45			2	50	1.5/8	41
T4020-2424	38	1.1/2	1.1/2" -11		-2424	3.74	95	1.77	45			2.3/16	55	2	50
T4020-3232	51	2	2" -11		-3232	4.21	107	2.13	54			2.3/4	70	2.1/2	

### BSPT

### T4340

BSPT MALE SWIVEL  
90° ELBOW  
60° SEAT

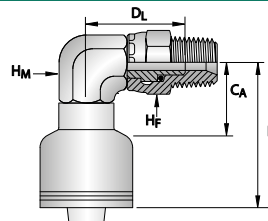

PART NO.	HOSE SIZE		THREAD SIZE	TUBE SIZE	DASH SIZE	DIMENSIONS						SPANNER			
	DN	inch	inch			L		C <sub>A</sub>		D <sub>L</sub>		H <sub>F</sub>		H <sub>M</sub>	
T4340-0808	12	1/2	1/2" -14		-0808	2.13	54	1.14	29	2.05	52	1		7/8	

# ONE-PIECE COUPLINGS

## T4000 SERIES ONE-PIECE CRIMP COUPLINGS

**BSPP**

**T4050**

BSPP FEMALE  
60° CONE  
90° ELBOW

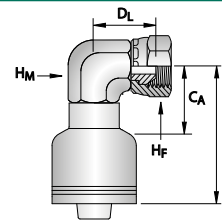

PART NO.	HOSE SIZE		THREAD SIZE	TUBE SIZE	DASH SIZE	DIMENSIONS						SPANNER			
	DN	inch	inch			L		CA		DL		HF		HM	
	DN	inch	inch			inch	mm	inch	mm	inch	mm	inch	mm	inch	mm
<b>T4050-0808</b>	12	1/2	1/2" -14		-0808	2.13	54	1.14	29	1.22	31	1.1/16	27	7/8	22
<b>T4050-2020</b>	31	1.1/4	1.1/4" -11		-2020	3.50	89	1.69	43	2.05	52	2	50	1.7/8	

**BSPP**

**T4260**

BSPP FEMALE  
60° CONE  
90° TUBE BEND

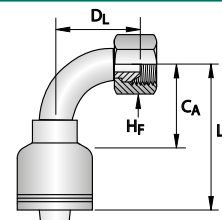

PART NO.	HOSE SIZE		THREAD SIZE	TUBE SIZE	DASH SIZE	DIMENSIONS						SPANNER			
	DN	inch	inch			L		CA		DL		HF		HM	
	DN	inch	inch			inch	mm	inch	mm	inch	mm	inch	mm		
<b>T4260-0404</b>	6	1/4	1/4" -19		-0404	2.05	52	1.06	27	1.14	29	3/4	19		
<b>T4260-0606</b>	10	3/8	3/8" -19		-0606	2.28	58	1.38	35	1.30	33	7/8	22		
<b>T4260-0608</b>	10	3/8	1/2" -14		-0608	2.28	58	1.38	35	1.30	33	1.1/16	27		
<b>T4260-0808</b>	12	1/2	1/2" -14		-0808	2.48	63	1.50	38	1.77	45	1.1/16	27		
<b>T4260-1010</b>	16	5/8	5/8" -14		-1010	3.03	77	1.77	45	1.97	50	1.3/16	30		
<b>T4260-1212</b>	19	3/4	3/4" -14		-1212	3.39	86	2.17	55	2.32	59	1.1/4	32		
<b>T4260-1616</b>	25	1	1" -11		-1616	4.02	102	2.68	74	3.07	78	1.1/2	38		32

## T4000 SERIES ONE-PIECE CRIMP COUPLINGS

**NPTF**

**T4090**

NPTF MALE  
60° SEAT

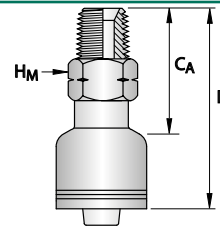

PART NO.	HOSE SIZE		THREAD SIZE	TUBE SIZE	DASH SIZE	DIMENSIONS				SPANNER				
	DN	inch	inch			L		C <sub>A</sub>		D <sub>L</sub>	H <sub>F</sub>		H <sub>M</sub>	
	DN	inch	inch			inch	mm	inch	mm		inch	mm	inch	mm
T4090-0202	4	1/8	1/8"-27		-0202	1.34	34	0.79	20				1/2	
T4090-0302	5	3/16	1/8"-27		-0302	1.73	44	0.94	24				7/16	11
T4090-0304	5	3/16	1/4"-18		-0304	1.97	50	1.18	30				9/16	
T4090-0402	6	1/4	1/8"-27		-0402	2.01	51	1.02	26				1/2	
T4090-0404	6	1/4	1/4"-18		-0404	2.17	55	1.18	30				9/16	
T4090-0504	8	5/16	1/4"-18		-0504	2.17	55	1.18	30				9/16	
T4090-0506	8	5/16	3/8"-18		-0506	2.17	55	1.18	30				11/16	
T4090-0604	10	3/8	1/4"-18		-0604	2.20	56	1.30	33				5/8	16
T4090-0606	10	3/8	3/8"-18		-0606	2.20	56	1.30	33				11/16	
T4090-0608	10	3/8	1/2"-14		-0608	2.40	61	1.46	37				7/8	22
T4090-0806	12	1/2	3/8"-18		-0806	2.36	60	1.38	35				11/16	
T4090-0808	12	1/2	1/2"-14		-0808	2.56	65	1.57	40				7/8	22
T4090-0812	12	1/2	3/4"-14		-0812	2.44	62	1.46	37				1.1/16	27
T4090-1012	16	5/8	3/4"-14		-1012	2.83	72	1.61	41				1.1/16	27
T4090-1212	19	3/4	3/4"-14		-1212	2.83	72	1.61	41				1.1/16	27
T4090-1416	22	7/8	1"-11,5		-1416	2.91	74	1.69	43				1.3/8	35
T4090-1616	25	1	1"-11,5		-1616	3.19	81	1.89	48				1.3/8	35
T4090-1820	28	1.1/8	1.1/4"-11,5		-1820	3.11	79	1.81	46				1.3/4	
T4090-2016	31	1.1/4	1"-11,5		-2016	3.90	99	2.05	52				1.3/4	
T4090-2020	31	1.1/4	1.1/4"-11,5		-2020	3.90	99	2.09	53				1.3/4	
T4090-2224	35	1.3/8	1.1/2"-11,5		-2224	3.98	101	2.13	54				2	50
T4090-2424	38	1.1/2	1.1/2"-11,5		-2424	4.13	105	2.17	55				2	50
T4090-2932	46	1.13/16	2"-11,5		-2932	4.69	119	2.60	66				2.1/2	
T4090-3232	51	2	2"-11,5		-3232	4.69	119	2.60	66				2.1/2	

**NPTF**

**T4320N**

NPTF MALE SWIVEL  
60° SEAT

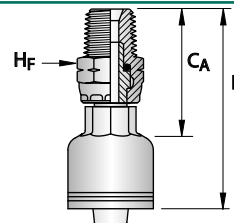

PART NO.	HOSE SIZE		THREAD SIZE	TUBE SIZE	DASH SIZE	DIMENSIONS				SPANNER				
	DN	inch	inch			L		C <sub>A</sub>		D <sub>L</sub>	H <sub>F</sub>		H <sub>M</sub>	
	DN	inch	inch			inch	mm	inch	mm		inch	mm	inch	
T4320N-0202	4	1/8	1/8"-27		-0202	1.89	48	1.34	34				1/2	
T4320N-0806	12	1/2	3/8"-18		-0806	2.36	60	1.38	35			7/8	22	

# ONE-PIECE COUPLINGS

## T4000 SERIES ONE-PIECE CRIMP COUPLINGS

**NPSM**

**T4020N**

NPSM FEMALE  
60° CONE

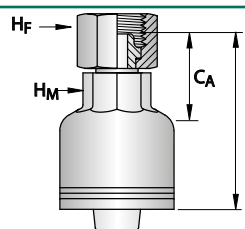

PART NO.	HOSE SIZE		THREAD SIZE	TUBE SIZE	DASH SIZE	DIMENSIONS				SPANNER					
	DN	inch	inch			L		C <sub>A</sub>		D <sub>L</sub>		H <sub>F</sub>		H <sub>M</sub>	
	DN	inch	inch			inch	mm	inch	mm			inch	mm	inch	mm
T4020N-0404	6	1/4	1/4" -18		-0404	1.85	47	0.87	22			11/16		1/2	
T4020N-0606	10	3/8	3/8" -18		-0606	1.89	48	0.94	24			7/8	22	5/8	16
T4020N-0808	12	1/2	1/2" -14		-0808	2.01	51	1.02	26			1		3/4	19

**JIC**

**T4030**

JIC  
37° CONE  
MALE

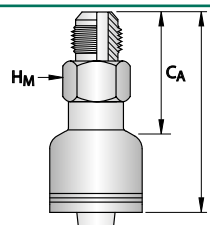

PART NO.	HOSE SIZE		THREAD SIZE	TUBE SIZE	DASH SIZE	DIMENSIONS				SPANNER					
	DN	inch	inch			L		C <sub>A</sub>		D <sub>L</sub>		H <sub>F</sub>		H <sub>M</sub>	
	DN	inch	inch			inch	mm	inch	mm			inch	mm	inch	mm
T4030-0307	5	3/16	7/16" -20		-0307	1.89	48	1.10	28					7/16	11
T4030-0407	6	1/4	7/16" -20		-0407	2.17	55	1.14	29					1/2	
T4030-0408	6	1/4	1/2" -20		-0408	2.17	55	1.14	29					9/16	
T4030-0409	6	1/4	9/16" -18		-0409	2.17	55	1.18	30					5/8	16
T4030-0609	10	3/8	9/16" -18		-0609	2.20	56	1.26	32					5/8	16
T4030-0612	10	3/8	3/4" -16		-0612	2.28	58	1.38	35					3/4	19
T4030-0812	12	1/2	3/4" -16		-0812	2.44	62	1.46	37					3/4	19
T4030-0814	12	1/2	7/8" -14		-0814	2.52	64	1.54	39					15/16	24
T4030-1014	16	5/8	7/8" -14		-1014	2.83	72	1.57	40					15/16	24
T4030-1017	16	5/8	1.1/16" -12		-1017	2.95	75	1.69	43					1.1/8	
T4030-1217	19	3/4	1.1/16" -12		-1217	2.95	75	1.73	44					1.1/8	
T4030-2430	38	1.1/2	1.7/8" -12		-2430	4.17	106	2.24	57					2	50

**JIC**

**T4031**

JIC  
37° CONE MALE  
METRIC HEX ONLY

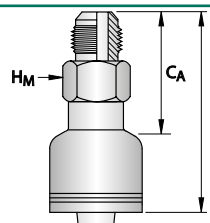

PART NO.	HOSE SIZE		THREAD SIZE	TUBE SIZE	DASH SIZE	DIMENSIONS				SPANNER					
	DN	inch	inch			L		C <sub>A</sub>		D <sub>L</sub>		H <sub>F</sub>		H <sub>M</sub>	
	DN	inch	inch			inch	mm	inch	mm			inch	mm	inch	mm
T4031-0407	6	1/4	7/16" -20		-0407	2.17	55	1.14	29						12

## T4000 SERIES ONE-PIECE CRIMP COUPLINGS

JSEAL™ / JIC

T4040

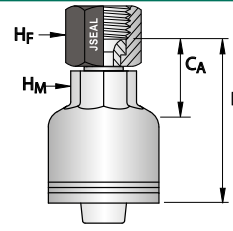

JSEAL™ / JIC FEMALE  
CONVEX SEAT

PART NO.	HOSE SIZE		THREAD SIZE	TUBE SIZE	DASH SIZE	DIMENSIONS				SPANNER					
	DN	inch	inch			L		C <sub>A</sub>		D <sub>L</sub>		H <sub>F</sub>		H <sub>M</sub>	
						inch	mm	inch	mm			inch	mm	inch	mm
T4040-0307	5	3/16	7/16" -20		-0307	1.61	41	0.87	22			9/16		1/2	
T4040-0308	5	3/16	1/2" - 20		-0308	1.61	41	0.87	22			5/8	16	1/2	
T4040-0309	5	3/16	9/16" -18		-0309	1.65	42	0.87	22			11/16		9/16	
T4040-0406	6	1/4	3/8" - 24		-0406	1.85	47	0.87	22			1/2		1/2	
T4040-0407	6	1/4	7/16" -20		-0407	1.73	44	0.75	19			9/16		1/2	
T4040-0408	6	1/4	1/2" - 20		-0408	1.81	46	0.83	21			5/8	16	1/2	
T4040-0409	6	1/4	9/16" -18		-0409	1.89	48	0.87	22			11/16		1/2	
T4040-0508	8	5/16	1/2" - 20		-0508	1.85	47	0.87	22			5/8	16	9/16	
T4040-0509	8	5/16	9/16" -18		-0509	1.85	47	0.87	22			11/16		9/16	
T4040-0512	8	5/16	3/4" -16		-0512	1.93	49	0.94	24			7/8	22	11/16	
T4040-0607	10	3/8	7/16" -20		-0607	1.85	47	0.87	22			9/16		9/16	
T4040-0609	10	3/8	9/16" -18		-0609	1.85	47	0.87	22			11/16		9/16	16
T4040-0612	10	3/8	3/4" -16		-0612	2.01	50	1.02	25			7/8	22	9/16	16
T4040-0809	12	1/2	9/16" -18		-0809	2.68	68	1.69	43			11/16		11/16	
T4040-0812	12	1/2	3/4" -16		-0812	1.93	51	0.94	25			7/8	22	11/16	19
T4040-0814	12	1/2	7/8" -14		-0814	2.05	52	1.06	27			1		11/16	
T4040-0817	12	1/2	1.1/16" -12		-0817	2.20	56	1.22	31			1.1/4	32	11/16	
T4040-1014	16	5/8	7/8" -14		-1014	2.28	58	1.06	27			1		7/8	22
T4040-1017	16	5/8	1.1/16" -12		-1017	2.44	62	1.18	30			1.1/4	32	7/8	22
T4040-1214	19	3/4	7/8" -14		-1214	2.52	62	1.34	32			1		1.1/16	27
T4040-1217	19	3/4	1.1/16" -12		-1217	2.44	60	1.22	29			1.1/4	32	1.1/16	27
T4040-1421	22	7/8	1.5/16" -12		-1421	2.56	65	1.34	34			1.1/2	38	1.1/4	32
T4040-1617	25	1	1.1/16" -12		-1617	2.68	68	1.34	37			1.1/4	32	1.1/4	32
T4040-1621	25	1	1.5/16" -12		-1621	2.72	69	1.38	33			1.1/2	38	1.1/4	32
T4040-1826	28	1.1/8	1.5/8" -12		-1826	2.95	75	1.61	41			2	50	1.5/8	41
T4040-2021	31	1.1/4	1.5/16" -12		-2021	3.62	92	1.69	43			1.1/2	38	1.5/8	41
T4040-2026	31	1.1/4	1.5/8" -12		-2026	3.62	92	1.69	43			2	50	1.5/8	41
T4040-2230	35	1.3/8	1.7/8" -12		-2230	3.58	91	1.73	44			2.1/4	57	2	50
T4040-2430	38	1.1/2	1.7/8" -12		-2430	4.06	103	2.09	53			2.1/4	57	2	50
T4040-2940	46	1.13/16	2.1/2" -12		-2940	4.45	113	2.36	60			2.7/8	73	2.1/2	
T4040-3240	51	2	2.1/2" -12		-3240	4.49	114	2.44	62			2.7/8	73	2.1/2	

INTRODUCTION

INDEXES

ONE-PIECE  
COUPLINGS

PUSH-ON SUCTION &  
RETURN COUPLINGS

FIELD ATTACHABLE  
COUPLINGS

HYDRAULIC FITTINGS  
ACCESSORIES

# ONE-PIECE COUPLINGS

## T4000 SERIES ONE-PIECE CRIMP COUPLINGS

JSEAL™ / JIC

T4041

JSEAL™ / JIC FEMALE  
CONVEX SEAT  
METRIC NUT ONLY

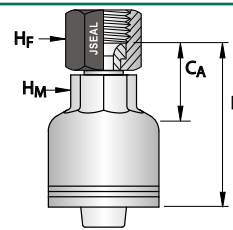

PART NO.	HOSE SIZE		THREAD SIZE	TUBE SIZE	DASH SIZE	DIMENSIONS						SPANNER		
	DN	inch	inch			L		Ca		Dl		Hf		Hm
						inch	mm	inch	mm			inch	mm	inch
T4041-0307	5	3/16	7/16" -20		-0307	1.61	41	0.87	22				14	1/2
T4041-0309	5	3/16	9/16" -18		-0309	1.65	42	0.87	22			3/4	19	9/16
T4041-0407	6	1/4	7/16" -20		-0407	1.73	44	0.75	19				14	1/2
T4041-0409	6	1/4	9/16" -18		-0409	1.89	48	0.87	22			3/4	19	1/2
T4041-0509	8	5/16	9/16" -18		-0509	1.85	47	0.87	22			3/4	19	9/16
T4041-0607	10	3/8	7/16" -20		-0607	1.85	47	0.87	22				14	9/16
T4041-0609	10	3/8	9/16" -18		-0609	1.85	47	0.87	22			3/4	19	9/16
T4041-0809	12	1/2	9/16" -18		-0809	2.68	68	1.69	43			3/4	19	11/16

JSEAL™ / JIC

T4250

JSEAL™ / JIC FEMALE  
CONVEX SEAT  
45° TUBE BEND

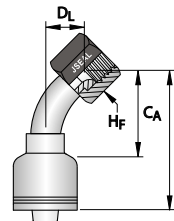

PART NO.	HOSE SIZE		THREAD SIZE	TUBE SIZE	DASH SIZE	DIMENSIONS						SPANNER		
	DN	inch	inch			L		Ca		Dl		Hf		Hm
						inch	mm	inch	mm	inch	mm	inch	mm	
T4250-0307	5	3/16	7/16" -20		-0307	1.97	50	1.22	31	0.39	10	9/16		
T4250-0407	6	1/4	7/16" -20		-0407	2.56	65	1.57	40	0.59	15	9/16		
T4250-0408	6	1/4	1/2" - 20		-0408	2.28	58	1.30	33	0.59	15	5/8	16	
T4250-0409	6	1/4	9/16" -18		-0409	2.28	58	1.30	33	0.59	15	11/16		
T4250-0509	8	5/16	9/16" -18		-0509	2.60	66	1.57	40	0.63	16	11/16		
T4250-1017	16	5/8	1.1/16" -12		-1017	3.39	86	2.13	54	0.94	24	1.1/4	32	
T4250-1217	19	3/4	1.1/16" -12		-1217	4.29	107	3.11	77	1.10	28	1.1/4	32	
T4250-1621	25	1	1.5/16" -12		-1621	4.65	118	3.31	82	1.38	35	1.1/2	38	
T4250-2026	31	1.1/4	1.5/8" -12		-2026	5.87	149	3.94	100	1.54	39	2	50	

## T4000 SERIES ONE-PIECE CRIMP COUPLINGS

### JSEAL™ / JIC

### T4251

JSEAL™ / JIC FEMALE  
CONVEX SEAT  
45° TUBE BEND  
METRIC NUT ONLY

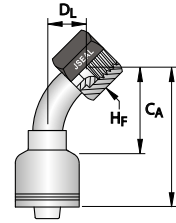

PART NO.	HOSE SIZE		THREAD SIZE	TUBE SIZE	DASH SIZE	DIMENSIONS						SPANNER		
	DN	inch	inch			L		C <sub>A</sub>		D <sub>L</sub>		H <sub>F</sub>		H <sub>M</sub>
T4251-0307	5	3/16	7/16" -20		-0307	1.97	50	1.22	31	0.39	10		14	
T4251-0407	6	1/4	7/16" -20		-0407	2.56	65	1.57	40	0.59	15		14	
T4251-0409	6	1/4	9/16" -18		-0409	2.28	58	1.30	33	0.59	15	3/4	19	
T4251-0509	8	5/16	9/16" -18		-0509	2.60	66	1.57	40	0.63	16	3/4	19	

### JSEAL™ / JIC

### T4243

JSEAL™ / JIC FEMALE  
CONVEX SEAT 90° SHORT TUBE BEND

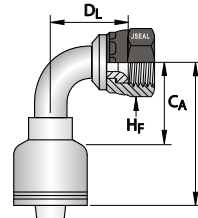

PART NO.	HOSE SIZE		THREAD SIZE	TUBE SIZE	DASH SIZE	DIMENSIONS						SPANNER		
	DN	inch	inch			L		C <sub>A</sub>		D <sub>L</sub>		H <sub>F</sub>		H <sub>M</sub>
T4243-0407	6	1/4	7/16" -20		-0407	2.44	62	1.46	37	0.83	21	9/16		
T4243-0409	6	1/4	9/16" -18		-0409	2.05	52	1.06	27	0.87	22	11/16		
T4243-0609	10	3/8	9/16" -18		-0609	2.20	56	1.22	31	0.91	23	11/16		
T4243-0812	12	1/2	3/4" -16		-0812	2.68	68	1.69	43	1.14	29	7/8	22	

INTRODUCTION

INDEXES

ONE-PIECE  
COUPLINGS

PUSH-ON SUCTION &  
RETURN COUPLINGS

FIELD ATTACHABLE  
COUPLINGS

HYDRAULIC FITTINGS  
ACCESSORIES

# ONE-PIECE COUPLINGS

## T4000 SERIES ONE-PIECE CRIMP COUPLINGS

JSEAL™ / JIC

T4240

JSEAL™ / JIC FEMALE  
CONVEX SEAT  
90° TUBE BEND

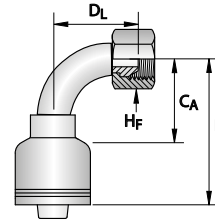

PART NO.	HOSE SIZE		THREAD SIZE	TUBE SIZE	DASH SIZE	DIMENSIONS						SPANNER		
	DN	inch	inch			L		CA		DL		HF		HM
	DN	inch	inch			inch	mm	inch	mm	inch	mm	inch	mm	
T4240-0307	5	3/16	7/16" -20		-0307	1.85	47	1.06	27	0.98	25	9/16		
T4240-0407	6	1/4	7/16" -20		-0407	2.52	64	1.54	39	1.26	32	9/16		
T4240-0408	6	1/4	1/2" - 20		-0408	2.24	57	1.26	32	1.26	32	5/8	16	
T4240-0409	6	1/4	9/16" -18		-0409	2.28	58	1.30	33	1.50	38	11/16		
T4240-0509	8	5/16	9/16" -18		-0509	2.32	59	1.34	34	1.18	30	11/16		
T4240-0609	10	3/8	9/16" -18		-0609	2.32	59	1.34	34	1.02	26	11/16		
T4240-0612	10	3/8	3/4" -16		-0612	2.36	60	1.38	35	1.18	30	7/8	22	
T4240-0812	12	1/2	3/4" -16		-0812	2.60	66	1.61	41	1.50	38	7/8	22	
T4240-0814	12	1/2	7/8" -14		-0814	2.60	66	1.61	41	1.61	41	1		
T4240-1017	16	5/8	1.1/16" -12		-1017	3.03	77	1.77	45	1.89	48	1.1/4	32	
T4240-1217	19	3/4	1.1/16" -12		-1217	3.54	88	2.32	57	2.24	57	1.1/4	32	
T4240-1621	25	1	1.5/16" -12		-1621	3.98	101	2.68	74	2.83	72	1.1/2	38	
T4240-1826	28	1.1/8	1.5/8" -12		-1826	4.74	121	3.43	87	3.19	81			
T4240-2021	31	1.1/4	1.5/16" -12		-2021	5.47	139	3.54	90	2.83	72	1.1/2	38	
T4240-2026	31	1.1/4	1.5/8" -12		-2026	5.87	149	3.94	100	3.19	81	2	50	
T4240-2430	38	1.1/2	1.7/8" -12		-2430	6.10	155	4.17	106	4.17	106	2.1/4	57	
T4240-3240	51	2	2.1/2" -12		-3240	7.91	201	5.83	148	5.20	132	2.7/8	73	

JSEAL™ / JIC

T4241

JSEAL™ / JIC FEMALE  
CONVEX SEAT  
90° TUBE BEND  
METRIC NUT ONLY

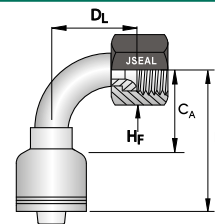

PART NO.	HOSE SIZE		THREAD SIZE	TUBE SIZE	DASH SIZE	DIMENSIONS						SPANNER		
	DN	inch	inch			L		CA		DL		HF		HM
	DN	inch	inch			inch	mm	inch	mm	inch	mm	inch	mm	
T4241-0407	6	1/4	7/16" -20		-0407	2.52	64	1.54	39	1.26	32	14		
T4241-0409	6	1/4	9/16" -18		-0409	2.28	58	1.30	33	1.50	38	3/4	19	
T4241-0509	8	5/16	9/16" -18		-0509	2.32	59	1.34	34	1.18	30	3/4	19	
T4241-0609	10	3/8	9/16" -18		-0609	2.32	59	1.34	34	1.02	26	3/4	19	

## T4000 SERIES ONE-PIECE CRIMP COUPLINGS

### JSEAL™ / JIC

### T4280

JSEAL™ / JIC FEMALE  
CONVEX SEAT  
90° LONG TUBE BEND

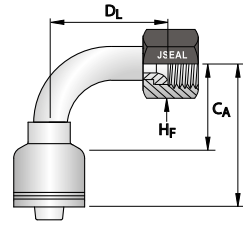

PART NO.	HOSE SIZE		THREAD SIZE	TUBE SIZE	DASH SIZE	DIMENSIONS						SPANNER		
	DN	inch	inch			L		CA		DL		HF		HM
T4280-0509	8	5/16	9/16" -18		-0509	3.03	77	2.05	52	2.17	55	11/16		
T4280-0609	10	3/8	9/16" -18		-0609	2.99	76	2.05	52	2.17	55	11/16		
T4280-0612	10	3/8	3/4" -16		-0612	2.99	76	2.05	52	2.52	64	7/8	22	

### JSEAL™ / JIC

### T4281

JSEAL™ / JIC FEMALE  
CONVEX SEAT  
90° LONG TUBE BEND  
METRIC NUT ONLY

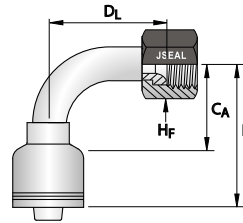

PART NO.	HOSE SIZE		THREAD SIZE	TUBE SIZE	DASH SIZE	DIMENSIONS						SPANNER		
	DN	inch	inch			L		CA		DL		HF		HM
T4281-0509	8	5/16	9/16" -18		-0509	3.03	77	2.05	52	2.17	55	3/4	19	
T4281-0609	10	3/8	9/16" -18		-0609	2.99	76	2.05	52	2.17	55	3/4	19	

### JIS

### T4122

BSPP FEMALE  
60° CONCAVE SEAT (JIS)

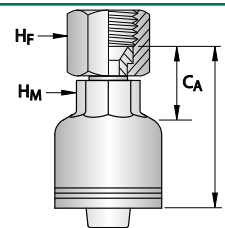

PART NO.	HOSE SIZE		THREAD SIZE	TUBE SIZE	DASH SIZE	DIMENSIONS						SPANNER		
	DN	inch	inch			L		CA		DL		HF		HM
T4122-0404	6	1/4	1/4" -19		-0404	1.93	49	0.94	24			3/4	19	14
T4122-0606	10	3/8	3/8" -19		-0606	1.93	49	0.98	25			7/8	22	17
T4122-0608	10	3/8	1/2" -14		-0608	1.99	51	1.05	27			1.1/16	27	
T4122-0808	12	1/2	1/2" -14		-0808	2.05	52	1.06	27			1.1/16	27	3/4 19
T4122-1212	19	3/4	3/4" -14		-1212	2.40	61	1.18	30			36	1.1/16	27
T4122-1616	25	1	1" -11		-1616	2.60	66	1.26	32			1.5/8	41	36

# ONE-PIECE COUPLINGS

## T4000 SERIES ONE-PIECE CRIMP COUPLINGS

### METRIC - DKL

### T4600

DKL FEMALE  
24° / 60° CONE

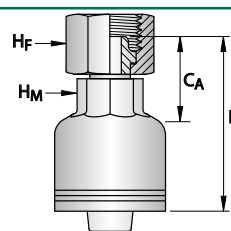

PART NO.	HOSE SIZE		THREAD SIZE	TUBE SIZE	DASH SIZE	DIMENSIONS						SPANNER			
	DN	inch	mm			L		C <sub>A</sub>		D <sub>L</sub>		H <sub>F</sub>		H <sub>M</sub>	
T4600-0616	10	3/8	M 16X1,5		-0616	1.85	47	0.91	23			3/4	19		
T4600-0618	10	3/8	M 18X1,5		-0618	1.85	47	0.91	23			7/8	22		
T4600-0622	10	3/8	M 22X1,5		-0622	1.97	50	1.02	26			1.1/16	27		
T4600-1230	19	3/4	M 30X2		-1230	2.28	58	1.06	27				36		

### METRIC - DKL

### T4660

DKL FEMALE  
24° / 60° CONE  
45° TUBE BEND

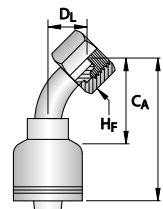

PART NO.	HOSE SIZE		THREAD SIZE	TUBE SIZE	DASH SIZE	DIMENSIONS						SPANNER			
	DN	inch	mm			L		C <sub>A</sub>		D <sub>L</sub>		H <sub>F</sub>		H <sub>M</sub>	
T4660-0616	10	3/8	M 16X1,5		-0616	2.72	69	1.77	45	0.79	20	3/4	19		
T4660-0618	10	3/8	M 18X1,5		-0618	2.72	69	1.77	45	0.79	20	7/8	22		
T4660-0622	10	3/8	M 22X1,5		-0622	2.76	70	1.81	46	0.83	21	1.1/16	27		
T4660-1230	19	3/4	M 30X2		-1230	4.09	104	2.87	73	1.26	32		36		

### DKL

### T4670

DKL FEMALE  
24° / 60° CONE  
90° TUBE BEND

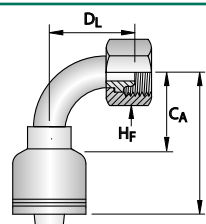

PART NO.	HOSE SIZE		THREAD SIZE	TUBE SIZE	DASH SIZE	DIMENSIONS						SPANNER			
	DN	inch	mm			L		C <sub>A</sub>		D <sub>L</sub>		H <sub>F</sub>		H <sub>M</sub>	
T4670-0616	10	3/8	M 16X1,5		-0616	2.32	59	1.38	35	1.38	35	3/4	19		
T4670-0618	10	3/8	M 18X1,5		-0618	2.28	58	1.34	34	1.38	35	7/8	22		
T4670-0622	10	3/8	M 22X1,5		-0622	2.28	58	1.34	34	1.46	37	1.1/16	27		
T4670-1230	19	3/4	M 30X2		-1230	3.43	87	2.20	56	2.52	64		36		

## T4000 SERIES ONE-PIECE CRIMP COUPLINGS

### METRIC - DKOL

### T4501

DKOL FEMALE  
24° CONE

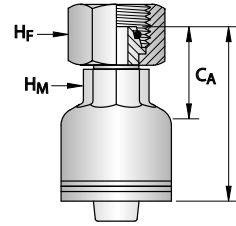

PART NO.	HOSE SIZE		THREAD SIZE	TUBE SIZE	DASH SIZE	DIMENSIONS				SPANNER					
	DN	inch	mm			L		CA		DL		HF		HM	
	DN	inch	mm			inch	mm	inch	mm			inch	mm	inch	mm
T4501-0822	12	1/2	M 22X1,5		-0822	2.24	57	1.26	32			1.1/16	27	11/16	
T4501-1018	16	5/8	M 18X1,5		-1018	2.48	63	1.23	31			7/8	22		
T4501-1030	16	5/8	M 30X2		-1030	2.64	67	1.42	36				36	7/8	22

### ORFS

### T4840

ORFS MALE

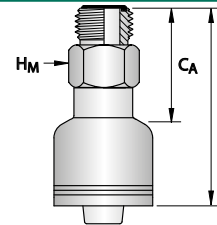

PART NO.	HOSE SIZE		THREAD SIZE	TUBE SIZE	DASH SIZE	DIMENSIONS				SPANNER					
	DN	inch	inch			L		CA		DL		HF		HM	
	DN	inch	inch			inch	mm	inch	mm					inch	mm
T4840-0409	6	1/4	9/16" - 18		-0409	1.97	50	0.98	25					5/8	16
T4840-0411	6	1/4	11/16" - 16		-0411	2.05	52	1.06	27					3/4	19
T4840-0513	8	5/16	13/16" - 16		-0513	2.20	56	1.22	31					7/8	22
T4840-0611	10	3/8	11/16" - 16		-0611	2.09	53	1.14	29					3/4	19
T4840-0613	10	3/8	13/16" - 16		-0613	2.17	55	1.22	31					7/8	22
T4840-0813	12	1/2	13/16" - 16		-0813	2.28	58	1.30	33					7/8	22
T4840-1016	16	5/8	1" - 14		-1016	2.68	68	1.46	37					1.1/16	27
T4840-1219	19	3/4	1.3/16" - 12		-1219	2.76	70	1.54	39					1.1/4	32
T4840-1223	19	3/4	1.7/16" - 12		-1223	2.76	70	1.57	40					1.1/2	38
T4840-1623	25	1	1.7/16" - 12		-1623	2.95	75	1.61	41					1.1/2	38
T4840-2027	31	1.1/4	1.11/16" - 12		-2027	3.62	92	1.77	45					1.3/4	

# ONE-PIECE COUPLINGS

## T4000 SERIES ONE-PIECE CRIMP COUPLINGS

ORFS

T4800

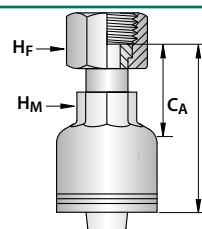

ORFS FEMALE

PART NO.	HOSE SIZE		THREAD SIZE	TUBE SIZE	DASH SIZE	DIMENSIONS						SPANNER			
	DN	inch	inch			L		C <sub>A</sub>		D <sub>L</sub>		H <sub>F</sub>		H <sub>M</sub>	
						inch	mm	inch	mm			inch	mm	inch	mm
T4800-0409	6	1/4	9/16" - 18		-0409	2.17	55	1.14	29			11/16		1/2	
T4800-0411	6	1/4	11/16" - 16		-0411	2.20	56	1.22	31			13/16		1/2	
T4800-0611	10	3/8	11/16" - 16		-0611	2.24	57	1.26	32			7/8	22	9/16	16
T4800-0613	10	3/8	13/16" - 16		-0613	2.36	60	1.38	35			15/16	24	9/16	16
T4800-0813	12	1/2	13/16" - 16		-0813	2.40	61	1.42	36			15/16	24	11/16	19
T4800-1219	19	3/4	1.3/16" - 12		-1219	3.07	72	1.85	41			1.3/8	35	1.1/16	24
T4800-1223	19	3/4	1.7/16" - 12		-1223	3.03	75	1.85	45			1.5/8	41	1.1/16	24
T4800-1619	25	1	1.3/16" - 12		-1619	3.19	81	1.85	45			1.3/8	35	1.1/4	32
T4800-1623	25	1	1.7/16" - 12		-1623	3.19	81	1.89	42			1.5/8	41	1.1/4	32
T4800-2027	31	1.1/4	1.11/16" - 12		-2027	4.13	105	2.17	55			2	50	1.5/8	41

ORFS

T4801

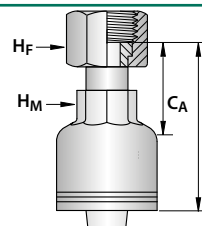

ORFS FEMALE  
METRIC NUT ONLY

PART NO.	HOSE SIZE		THREAD SIZE	TUBE SIZE	DASH SIZE	DIMENSIONS						SPANNER			
	DN	inch	inch			L		C <sub>A</sub>		D <sub>L</sub>		H <sub>F</sub>		H <sub>M</sub>	
						inch	mm	inch	mm			inch	mm	inch	mm
T4801-0409	6	1/4	9/16" - 18		-0409	2.17	55	1.14	29				17	1/2	
T4801-0411	6	1/4	11/16" - 16		-0411	2.20	56	1.22	31			7/8	22	1/2	
T4801-1219	19	3/4	1.3/16" - 12		-1219	3.07	72	1.85	41				36	1.1/16	27
T4801-1619	25	1	1.3/16" - 12		-1619	3.19	81	1.85	47				36	1.1/4	32

## T4000 SERIES ONE-PIECE CRIMP COUPLINGS

### ORFS

### T4810

ORFS FEMALE  
45° TUBE BEND

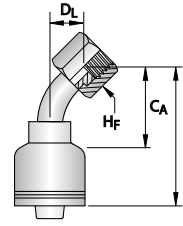

PART NO.	HOSE SIZE		THREAD SIZE	TUBE SIZE	DASH SIZE	DIMENSIONS						SPANNER			
	DN	inch	inch			L		C <sub>A</sub>		D <sub>L</sub>		H <sub>F</sub>		H <sub>M</sub>	
<b>T4810-0409</b>	6	1/4	9/16" - 18		-0409	2.52	64	1.54	39	0.71	18	11/16			
<b>T4810-0611</b>	10	3/8	11/16" - 16		-0611	2.72	69	1.77	45	0.79	20	7/8	22		
<b>T4810-0613</b>	10	3/8	13/16" - 16		-0613	2.52	64	1.57	40	0.67	17	15/16	24		
<b>T4810-0813</b>	12	1/2	13/16" - 16		-0813	2.91	74	1.93	49	0.75	19	15/16	24		
<b>T4810-1016</b>	16	5/8	1" - 14		-1016	3.58	91	2.32	59	0.79	20	1.1/8			
<b>T4810-1219</b>	19	3/4	1.3/16" - 12		-1219	4.29	107	3.11	77	1.14	29	1.3/8	35		
<b>T4810-1623</b>	25	1	1.7/16" - 12		-1623	4.72	120	3.39	84	1.34	34	1.5/8	41		
<b>T4810-2027</b>	31	1.1/4	1.11/16" - 12		-2027	5.94	151	4.02	102	1.77	45	2	50		

### ORFS

### T4811

ORFS FEMALE  
45° TUBE BEND  
METRIC NUT ONLY

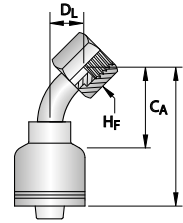

PART NO.	HOSE SIZE		THREAD SIZE	TUBE SIZE	DASH SIZE	DIMENSIONS						SPANNER			
	DN	inch	inch			L		C <sub>A</sub>		D <sub>L</sub>		H <sub>F</sub>		H <sub>M</sub>	
<b>T4811-0409</b>	6	1/4	9/16" - 18		-0409	2.52	64	1.54	39	0.71	18		17		
<b>T4811-1016</b>	16	5/8	1" - 14		-1016	3.58	91	2.32	59	0.79	20	1.3/16	30		
<b>T4811-1219</b>	19	3/4	1.3/16" - 12		-1219	4.29	109	3.11	79	1.14	29		36		

INTRODUCTION

INDEXES

ONE-PIECE  
COUPLINGS

PUSH-ON SUCTION &  
RETURN COUPLINGS

FIELD ATTACHABLE  
COUPLINGS

HYDRAULIC FITTINGS  
ACCESSORIES

# ONE-PIECE COUPLINGS

## T4000 SERIES ONE-PIECE CRIMP COUPLINGS

ORFS

T4820

ORFS FEMALE  
90° MEDIUM TUBE BEND

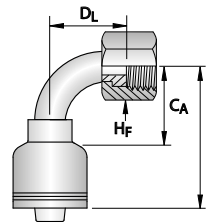

PART NO.	HOSE SIZE		THREAD SIZE	TUBE SIZE	DASH SIZE	DIMENSIONS						SPANNER		
	DN	inch	inch			L		C <sub>A</sub>		D <sub>L</sub>		H <sub>F</sub>		H <sub>M</sub>
						inch	mm	inch	mm	inch	mm	inch	mm	
T4820-0409	6	1/4	9/16" - 18		-0409	2.09	53	1.10	28	1.26	32	11/16		
T4820-0411	6	1/4	11/16" - 16		-0411	2.28	58	1.30	33	1.50	38	13/16		
T4820-0611	10	3/8	11/16" - 16		-0611	2.36	60	1.38	35	1.50	38	7/8	22	
T4820-0613	10	3/8	13/16" - 16		-0613	2.48	63	1.50	38	1.34	34	15/16	24	
T4820-0813	12	1/2	13/16" - 16		-0813	2.48	63	1.50	38	1.61	41	15/16	24	
T4820-1219	19	3/4	1.3/16" - 12		-1219	3.54	88	2.32	57	2.32	59	1.3/8	35	
T4820-1619	25	1	1.3/16" - 12		-1619	4.06	103	2.72	69	2.32	59	1.3/8	35	
T4820-1623	25	1	1.7/16" - 12		-1623	4.06	103	2.72	74	2.80	71	1.5/8	41	
T4820-2027	31	1.1/4	1.11/16" - 12		-2027	5.87	149	3.94	100	3.54	90	2	50	
T4820-2432	38	1.1/2	2" - 12		-2432	6.10	155	4.17	106	4.21	107	2.1/4	57	

ORFS

T4821

ORFS FEMALE  
90° MEDIUM TUBE BEND  
METRIC NUT ONLY

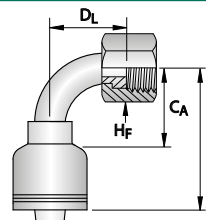

PART NO.	HOSE SIZE		THREAD SIZE	TUBE SIZE	DASH SIZE	DIMENSIONS						SPANNER		
	DN	inch	inch			L		C <sub>A</sub>		D <sub>L</sub>		H <sub>F</sub>		H <sub>M</sub>
						inch	mm	inch	mm	inch	mm	inch	mm	
T4821-0409	6	1/4	9/16" - 18		-0409	2.28	58	1.30	33	1.26	32		17	
T4821-1016	16	5/8	1" - 14		-1016	3.03	77	1.77	45	1.85	47	1.3/16	30	
T4821-1219	19	3/4	1.3/16" E-12		-1219	3.54	88	2.32	57	2.32	59		36	

ORFS

T4830

ORFS FEMALE  
90° LONG BEND

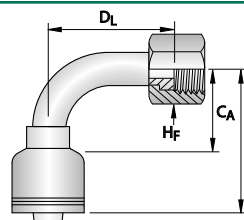

PART NO.	HOSE SIZE		THREAD SIZE	TUBE SIZE	DASH SIZE	DIMENSIONS						SPANNER		
	DN	inch	inch			L		C <sub>A</sub>		D <sub>L</sub>		H <sub>F</sub>		H <sub>M</sub>
						inch	mm	inch	mm	inch	mm	inch	mm	
T4830-1623	25	1	1.7/16" - 12		-1623	4.25	108	2.91	74	4.45	113	1.5/8	41	

## T4000 SERIES ONE-PIECE CRIMP COUPLINGS

### SAE T4530

SAE MALE  
45° CONE

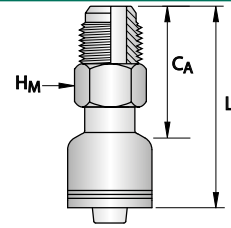

PART NO.	HOSE SIZE		THREAD SIZE	TUBE SIZE	DASH SIZE	DIMENSIONS						SPANNER			
	DN	inch	inch			L		C <sub>A</sub>		D <sub>L</sub>		H <sub>F</sub>		H <sub>M</sub>	
						inch	mm	inch	mm			inch	mm	inch	mm
T4530-0510	8	5/16	5/8" -18		-0510	2.20	56	1.22	31					11/16	
T4530-0610	10	3/8	5/8" -18		-0610	2.28	58	1.34	34					3/4	19

### SAE T4540

SAE FEMALE  
45° FLARE

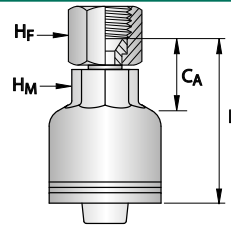

PART NO.	HOSE SIZE		THREAD SIZE	TUBE SIZE	DASH SIZE	DIMENSIONS						SPANNER			
	DN	inch	inch			L		C <sub>A</sub>		D <sub>L</sub>		H <sub>F</sub>		H <sub>M</sub>	
						inch	mm	inch	mm			inch	mm	inch	mm
T4540-0410	6	1/4	5/8" -18		-0410	1.89	48	0.91	23			3/4	19	5/8	16
T4540-0510	8	5/16	5/8" -18		-0510	1.77	45	0.79	20			3/4	19	5/8	16
T4540-0610	10	3/8	5/8" -18		-0610	1.85	47	0.91	23			3/4	19	5/8	16

### SAE T4570

SAE FEMALE  
45° FLARE  
90° ELBOW

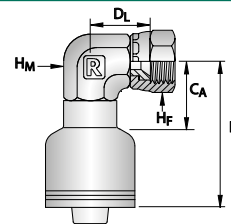

PART NO.	HOSE SIZE		THREAD SIZE	TUBE SIZE	DASH SIZE	DIMENSIONS						SPANNER			
	DN	inch	inch			L		C <sub>A</sub>		D <sub>L</sub>		H <sub>F</sub>		H <sub>M</sub>	
						inch	mm	inch	mm	inch	mm	inch	mm	inch	mm
T4570-0610	10	3/8	5/8" -18		-0610	1.85	47	0.91	23	0.91	23	3/4	19	3/4	19

INTRODUCTION

INDEXES

ONE-PIECE  
COUPLINGS

PUSH-ON SUCTION &  
RETURN COUPLINGS

FIELD ATTACHABLE  
COUPLINGS

HYDRAULIC FITTINGS  
ACCESSORIES

# ONE-PIECE COUPLINGS

## T4000 SERIES ONE-PIECE CRIMP COUPLINGS

SAE

T4550

SAE FEMALE  
45° FLARE  
45° TUBE BEND

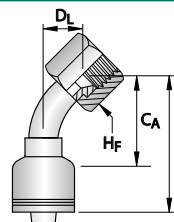

PART NO.	HOSE SIZE		THREAD SIZE	TUBE SIZE	DASH SIZE	DIMENSIONS						SPANNER			
	DN	inch	inch			L		CA		DL		HF		HM	
	DN	inch	inch			inch	mm	inch	mm	inch	mm	inch	mm	inch	mm
T4550-0510	8	5/16	5/8" -18		-0510	2.56	65	1.57	40	0.63	16	3/4	19		
T4550-0610	10	3/8	5/8" -18		-0610	2.48	63	1.54	39	0.67	17	3/4	19	3/4	19

SAE

T4560

SAE FEMALE  
45° FLARE  
90° TUBE BEND

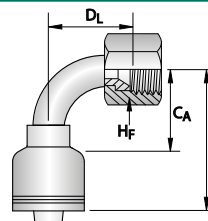

PART NO.	HOSE SIZE		THREAD SIZE	TUBE SIZE	DASH SIZE	DIMENSIONS						SPANNER			
	DN	inch	inch			L		CA		DL		HF		HM	
	DN	inch	inch			inch	mm	inch	mm	inch	mm	inch	mm		
T4560-0610	10	3/8	5/8" -18		-0610	2.32	59	1.38	35	1.26	32	3/4	19		

SAE

T4740

SAE INVERTED FLARE MALE

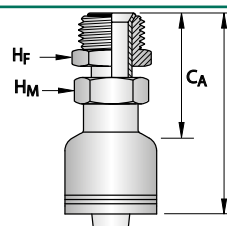

PART NO.	HOSE SIZE		THREAD SIZE	TUBE SIZE	DASH SIZE	DIMENSIONS						SPANNER			
	DN	inch	inch			L		CA		DL		HF		HM	
	DN	inch	inch			inch	mm	inch	mm			inch	mm	inch	mm
T4740-0610	10	3/8	5/8" -18		-0610	2.60	66	1.61	41			9/16			
T4740-0611	10	3/8	11/16" -16		-0611	2.64	67	1.73	44			5/8	16		

## T4000 SERIES ONE-PIECE CRIMP COUPLINGS

### SAE T4750

SAE INVERTED FLARE MALE  
45° TUBE BEND

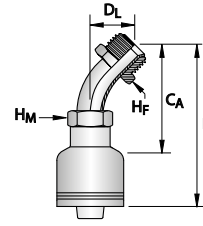

PART NO.	HOSE SIZE		THREAD SIZE	TUBE SIZE	DASH SIZE	DIMENSIONS						SPANNER			
	DN	inch	inch			L		C <sub>A</sub>		D <sub>L</sub>		H <sub>F</sub>		H <sub>M</sub>	
						inch	mm	inch	mm	inch	mm			inch	mm
<b>T4750-0510</b>	8	5/16	5/8" -18		-0510	3.86	98	2.87	73	0.91	23	9/16			
<b>T4750-0610</b>	10	3/8	5/8" -18		-0610	3.82	97	2.87	73	0.91	23	5/8	16		

### SAE T4770

SAE INVERTED FLARE MALE  
90° TUBE BEND

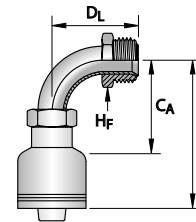

PART NO.	HOSE SIZE		THREAD SIZE	TUBE SIZE	DASH SIZE	DIMENSIONS						SPANNER			
	DN	inch	inch			L		C <sub>A</sub>		D <sub>L</sub>		H <sub>F</sub>		H <sub>M</sub>	
						inch	mm	inch	mm	inch	mm			inch	mm
<b>T4770-0510</b>	8	5/16	5/8" -18		-0510	3.15	80	2.17	55	1.97	50	9/16			
<b>T4770-0610</b>	10	3/8	5/8" -18		-0610	3.11	79	2.17	55	1.97	50	5/8	16		

INTRODUCTION

INDEXES

ONE-PIECE  
COUPLINGS

PUSH-ON SUCTION &  
RETURN COUPLINGS

FIELD ATTACHABLE  
COUPLINGS

HYDRAULIC FITTINGS  
ACCESSORIES

# ONE-PIECE COUPLINGS

## T4000 SERIES ONE-PIECE CRIMP COUPLINGS

### DIMENSIONS FOR SAE CODE 61 AND CODE 62 FLANGES, AND RYCO CODE 62C FLANGES

NOMINAL FLANGE	CODE 61				CODE 62				CODE 62C			
	B		T		B		T		B		T	
inch	mm	inch	mm	inch	mm	inch	mm	inch	mm	inch	mm	inch
1/2	30,2	1.19	6,73	0.265	31,8	1.25	7,75	0.305				
5/8	34,0	1.34	6,73	0.265								
3/4	38,1	1.50	6,73	0.265	41,3	1.63	8,76	0.345	41,3	1.63	14,20	0.559
1	44,5	1.75	8,00	0.315	47,6	1.88	9,53	0.375	47,6	1.88	14,20	0.559
1.1/4	50,8	2.00	8,00	0.315	54,0	2.12	10,29	0.405	54,0	2.12	14,20	0.559
1.1/2	60,3	2.38	8,00	0.315	63,5	2.50	12,57	0.495	63,5	2.50	14,20	0.559
2	71,4	2.81	9,53	0.375	79,4	3.13	12,57	0.495	79,4	3.13	14,20	0.559
2.1/2	84,1	3.31	9,53	0.375								
3	101,6	4.00	9,53	0.375								

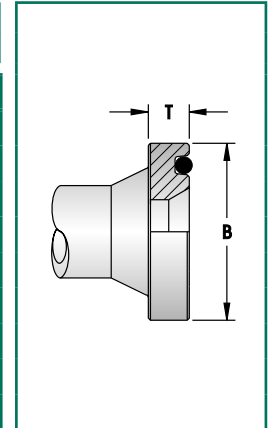

**NOTE:** Ryco Code 62C fittings conform to the flange OD and bolt hole patterns of SAE Code 62 but require special flange clamps. Ryco Code 62C flange heads are thicker than SAE Code 62 and measure T = 14,2 mm (0.559 inch) in all sizes.

## RYCOLOK

### T4870

RYCOLOK MALE STAPLE

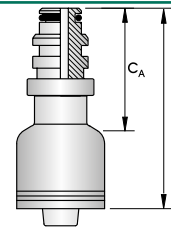

PART NO.	HOSE SIZE		THREAD SIZE	TUBE SIZE	DASH SIZE	DIMENSIONS				SPANNER		
	DN	inch				inch	mm	L	C <sub>A</sub>	D <sub>L</sub>	H <sub>F</sub>	H <sub>M</sub>
<b>T4870-3250</b>	51	2		50	-3250	4.33	110	2.28	58			

## SAE FLANGE

### T4130

SAE CODE 61 FLANGE

CLAMPS - SEE PAGES 274 & 282  
O RING NOT SUPPLIED

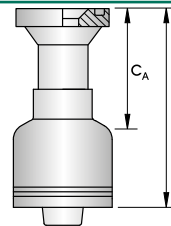

PART NO.	HOSE SIZE		THREAD SIZE	TUBE SIZE	DASH SIZE	DIMENSIONS				SPANNER		
	DN	inch				inch	mm	L	C <sub>A</sub>	D <sub>L</sub>	H <sub>F</sub>	H <sub>M</sub>
<b>T4130-1212</b>	19	3/4			-1212	3.03	77	1.81	46			
<b>T4130-1216</b>	19	3/4			-1216	3.19	81	1.97	50			
<b>T4130-1616</b>	25	1			-1616	3.35	85	2.05	52			
<b>T4130-1620</b>	25	1			-1620	3.54	90	2.24	57			
<b>T4130-2020</b>	31	1.1/4			-2020	4.13	105	2.32	59			
<b>T4130-2024</b>	31	1.1/4			-2024	5.16	131	3.35	85			
<b>T4130-2424</b>	38	1.1/2			-2424	5.31	135	3.39	86			
<b>T4130-2432</b>	38	1.1/2			-2432	5.71	145	3.78	96			
<b>T4130-3232</b>	51	2			-3232	5.87	149	3.78	96			
<b>T4130-4040</b>	63	2.1/2			-4040	5.75	146	3.11	79			

## T4000 SERIES ONE-PIECE CRIMP COUPLINGS

### SAE FLANGE

### T4150

SAE CODE 61 FLANGE  
45° TUBE BEND

CLAMPS - SEE PAGES 274 & 282  
O RING NOT SUPPLIED

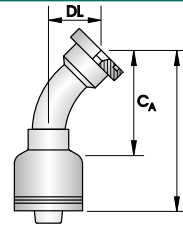

PART NO.	HOSE SIZE		THREAD SIZE	TUBE SIZE	DASH SIZE	DIMENSIONS						SPANNER	
	DN	inch				L		C <sub>A</sub>		D <sub>L</sub>		H <sub>F</sub>	H <sub>M</sub>
	DN	inch				inch	mm	inch	mm	inch	mm		
T4150-1212	19	3/4			-1212	3.78	96	2.56	65	1.02	26		
T4150-1616	25	1			-1616	4.53	115	3.19	81	1.18	30		
T4150-2020	31	1.1/4			-2020	5.79	147	3.94	100	1.42	36		
T4150-2420	38	1.1/2			-2420	5.76	146	3.82	97	1.42	36		
T4150-2424	38	1.1/2			-2424	6.26	159	4.33	110	1.65	42		
T4150-2432	38	1.1/2			-2432	6.65	169	4.72	120	1.85	47		

### SAE FLANGE

### T4170

SAE CODE 61 FLANGE  
90° TUBE BEND

CLAMPS - SEE PAGES 274 & 282  
O RING NOT SUPPLIED

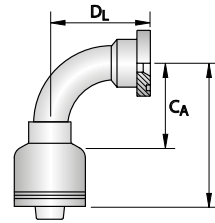

PART NO.	HOSE SIZE		THREAD SIZE	TUBE SIZE	DASH SIZE	DIMENSIONS						SPANNER	
	DN	inch				L		C <sub>A</sub>		D <sub>L</sub>		H <sub>F</sub>	H <sub>M</sub>
	DN	inch				inch	mm	inch	mm	inch	mm		
T4170-1212	19	3/4			-1212	3.39	86	2.17	55	2.13	54		
T4170-1616	25	1			-1616	4.02	102	2.68	68	2.68	68		
T4170-2020	31	1.1/4			-2020	5.00	127	3.15	80	3.07	78		
T4170-2424	38	1.1/2			-2424	6.02	153	4.09	104	3.66	93		
T4170-2432	38	1.1/2			-2432	5.75	146	3.82	97	3.90	99		
T4170-3232	51	2			-3232	7.48	190	5.39	137	5.12	130		
T4170-3240	51	2			-3240	7.64	194	5.55	141	5.28	134		

### SAE FLANGE

### T4173

SAE CODE 61 FLANGE  
90° LONG TUBE BEND

CLAMPS - SEE PAGES 274 & 282  
O RING NOT SUPPLIED

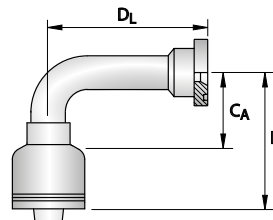

PART NO.	HOSE SIZE		THREAD SIZE	TUBE SIZE	DASH SIZE	DIMENSIONS						SPANNER	
	DN	inch				L		C <sub>A</sub>		D <sub>L</sub>		H <sub>F</sub>	H <sub>M</sub>
	DN	inch				inch	mm	inch	mm	inch	mm		
T4173-1620	25	1			-1620	3.98	101	2.64	67	3.66	93		

INTRODUCTION

INDEXES

ONE-PIECE  
COUPLINGS

PUSH-ON SUCTION &  
RETURN COUPLINGS

FIELD ATTACHABLE  
COUPLINGS

HYDRAULIC FITTINGS  
ACCESSORIES

# ONE-PIECE COUPLINGS

## T4000 SERIES ONE-PIECE CRIMP COUPLINGS

**UNO**

**T4200**

UN O RING MALE

O RING SUPPLIED

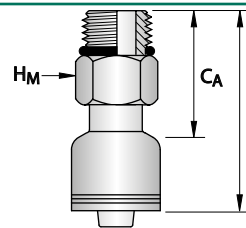

PART NO.	HOSE SIZE		THREAD SIZE	TUBE SIZE	DASH SIZE	DIMENSIONS				SPANNER			
	DN	inch	inch	inch		L		C <sub>A</sub>		D <sub>L</sub>	H <sub>F</sub>	H <sub>M</sub>	
						inch	mm	inch	mm			inch	mm
<b>T4200-0407</b>	6	1/4	7/16" -20	1/4	-0407	1.97	50	0.98	25			9/16	
<b>T4200-1621</b>	25	1	1.5/16" -12	1	-1621	2.83	72	1.54	39			1.1/2	38

**SALVAGE / LIFESAVER**

**T4230**

SALVAGE / LIFESAVER  
TUBE WELD

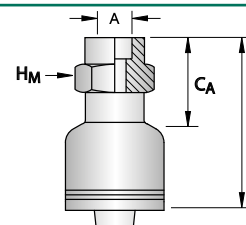

PART NO.	HOSE SIZE		THREAD SIZE	TUBE SIZE	DASH SIZE	DIMENSIONS				SPANNER			
	DN	inch	inch	inch		L		C <sub>A</sub>		D <sub>L</sub>	H <sub>F</sub>	H <sub>M</sub>	
						inch	mm	inch	mm			inch	mm
<b>T4230-0506</b>	8	5/16		3/8	-0506	1.69	43	0.71	18			9/16	
<b>T4230-0606</b>	10	3/8		3/8	-0606	1.65	42	0.71	18			5/8	16
<b>T4230-0808</b>	12	1/2		1/2	-0808	1.73	44	0.75	19			11/16	
<b>T4230-1212</b>	19	3/4		3/4	-1212	2.05	52	0.83	21			1	
<b>T4230-1012</b>	16	5/8		3/4	-1012	2.05	52	0.79	20			1.1/16	27
<b>T4230-1616</b>	25	1		1	-1616	2.40	61	1.10	28			1.3/8	35
<b>T4230-2020</b>	31	1.1/4		1.1/4	-2020	3.07	78	1.22	31			1.3/4	
<b>T4230-2424</b>	38	1.1/2		1.1/2	-2424	3.31	84	1.34	34			2	50
<b>T4230-3232</b>	51	2		2	-3232	3.70	94	1.61	41			2.1/2	

## T4000 SERIES ONE-PIECE CRIMP COUPLINGS

### TUBE BITE

### T4850

#### TUBE BITE

COMPLETE WITH NUT  
AND FLARELESS OLIVE

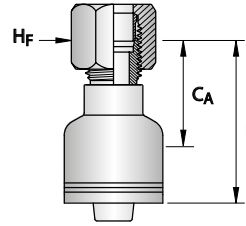

PART NO.	HOSE SIZE		THREAD SIZE	TUBE SIZE	DASH SIZE	DIMENSIONS						SPANNER			
	DN	inch				inch	inch	L		C <sub>A</sub>		D <sub>L</sub>		H <sub>F</sub>	
						inch	mm	inch	mm			inch	mm	inch	mm
<b>T4850-0606</b>	10	3/8		3/8	-0606	2.13	54	1.18	30			11/16		5/8	16

INTRODUCTION

INDEXES

ONE-PIECE  
COUPLINGS

PUSH-ON SUCTION &  
RETURN COUPLINGS

FIELD ATTACHABLE  
COUPLINGS

HYDRAULIC FITTINGS  
ACCESSORIES

# ONE-PIECE COUPLINGS

## T6000 SERIES ONE-PIECE CRIMP COUPLINGS

### HOSE COMPATIBILITY FOR T6000 SERIES

#### NON-SKIVE

For Ryco Hose Series H5000 (sizes -24 to -32).

For Ryco Hose Series H6000 (sizes -12 to -32).

### BSPT

### T6010

BSPT MALE  
60° SEAT

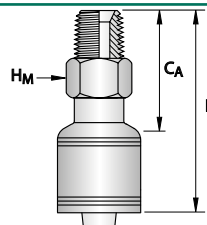

PART NO.	HOSE SIZE		THREAD SIZE	TUBE SIZE	DASH SIZE	DIMENSIONS					SPANNER			
	DN	inch	inch			L		CA		DL		HF	HM	
						inch	mm	inch	mm				inch	mm
T6010-1212	19	3/4	3/4" -14		-1212	3.70	94	1.65	42				1.1/16	27
T6010-1616	25	1	1" -11		-1616	4.53	115	1.93	49				1.3/8	35
T6010-2020	31	1.1/4	1.1/4" -11		-2020	4.84	123	2.17	55				1.3/4	
T6010-2424	38	1.1/2	1.1/2" -11		-2424	5.67	144	2.20	56				2	50
T6010-3232	51	2	2" -11		-3232	6.93	176	2.80	71				2.1/2	

### BSPP

### T6013

BSPP MALE  
60° SEAT

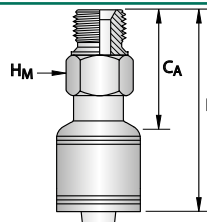

PART NO.	HOSE SIZE		THREAD SIZE	TUBE SIZE	DASH SIZE	DIMENSIONS					SPANNER			
	DN	inch	inch			L		CA		DL		HF	HM	
						inch	mm	inch	mm				inch	mm
T6013-1212	19	3/4	3/4" -14		-1212	3.66	93	1.61	41				1.1/4	32
T6013-1616	25	1	1" -11		-1616	4.41	112	1.81	46				1.5/8	41
T6013-2020	31	1.1/4	1.1/4" -11		-2020	4.76	121	2.09	53				2	50
T6013-2424	38	1.1/2	1.1/2" -11		-2424	5.63	143	2.17	55				2.3/16	55
T6013-3232	51	2	2" -11		-3232	6.97	177	2.83	72				2.3/4	70

## T6000 SERIES ONE-PIECE CRIMP COUPLINGS

### BSPP

### T6020

BSPP FEMALE  
60° CONE

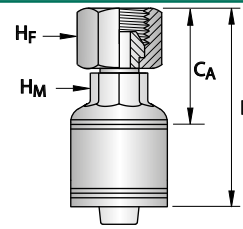

PART NO.	HOSE SIZE		THREAD SIZE	TUBE SIZE	DASH SIZE	DIMENSIONS						SPANNER			
	DN	inch	inch			L		C <sub>A</sub>		D <sub>L</sub>		H <sub>F</sub>		H <sub>M</sub>	
	DN	inch	inch			inch	mm	inch	mm			inch	mm	inch	mm
T6020-1212	19	3/4	3/4" -14		-1212	3.27	82	1.22	30			1.1/4	32	1.1/16	27
T6020-1616	25	1	1" -11		-1616	4.13	105	1.54	39			1.1/2	38	1.3/8	35
T6020-2016	31	1.1/4	1" -11		-2016	4.41	112	1.73	44			1.1/2	38	1.3/4	
T6020-2020	31	1.1/4	1.1/4" -11		-2020	4.45	113	1.77	45			2	50	1.3/4	
T6020-2424	38	1.1/2	1.1/2" -11		-2424	5.28	134	1.81	46			2.3/16	55	2	50
T6020-3232	51	2	2" -11		-3232	6.46	164	2.32	59			2.3/4	70	2.1/2	

### BSPP

### T6022

BSPP FEMALE  
60° CONE  
HEAVY

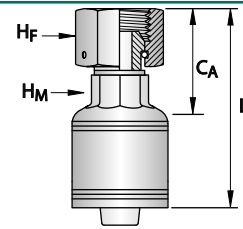

PART NO.	HOSE SIZE		THREAD SIZE	TUBE SIZE	DASH SIZE	DIMENSIONS						SPANNER			
	DN	inch	inch			L		C <sub>A</sub>		D <sub>L</sub>		H <sub>F</sub>		H <sub>M</sub>	
	DN	inch	inch			inch	mm	inch	mm			inch	mm	inch	mm
T6022-1212	19	3/4	3/4" -14		-1212	3.46	88	1.42	36			1.1/4	32	1.1/8	
T6022-1616	25	1	1" -11		-1616	4.09	104	1.54	39			1.1/2	38	1.1/2	38
T6022-2020	31	1.1/4	1.1/4" -11		-2020	4.49	114	1.81	46			2		1.3/4	

### BSPP

### T6270

BSPP FEMALE  
60° CONE  
45° TUBE BEND

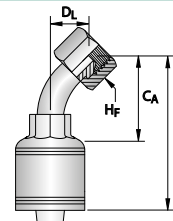

PART NO.	HOSE SIZE		THREAD SIZE	TUBE SIZE	DASH SIZE	DIMENSIONS						SPANNER			
	DN	inch	inch			L		C <sub>A</sub>		D <sub>L</sub>		H <sub>F</sub>		H <sub>M</sub>	
	DN	inch	inch			inch	mm	inch	mm	inch	mm	inch	mm	inch	mm
T6270-1212	19	3/4	3/4" -14		-1212	4.88	124	2.83	72	1.14	29	1.1/4	32		
T6270-1616	25	1	1" -11		-1616	6.22	158	3.62	92	1.54	39	1.1/2	38		
T6270-2020	31	1.1/4	1.1/4" -11		-2020	6.97	177	4.29	109	1.81	46	2	50		
T6270-2424	38	1.1/2	1.1/2" -11		-2424	8.50	216	5.04	128	2.05	52	2.3/16	55	2.3/16	55
T6270-3232	51	2	2" -11		-3232	9.96	253	5.83	148	2.56	65	2.3/4	70		

# ONE-PIECE COUPLINGS

## T6000 SERIES ONE-PIECE CRIMP COUPLINGS

**BSPP**

**T6260**

BSPP FEMALE  
60° CONE  
90° TUBE BEND

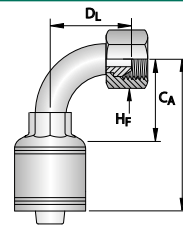

PART NO.	HOSE SIZE		THREAD SIZE	TUBE SIZE	DASH SIZE	DIMENSIONS						SPANNER			
	DN	inch	inch			L		CA		DL		HF		HM	
	DN	inch	inch			inch	mm	inch	mm	inch	mm	inch	mm	inch	mm
T6260-1212	19	3/4	3/4" -14		-1212	4.29	109	2.24	57	2.28	58	1.1/4	32	1.1/16	27
T6260-1616	25	1	1" -11		-1616	5.39	137	2.80	71	3.15	80	1.1/2	38		
T6260-2020	31	1.1/4	1.1/4" -11		-2020	6.18	157	3.50	89	3.58	91	2	50		
T6260-2424	38	1.1/2	1.1/2" -11		-2424	7.64	194	4.17	106	4.13	105	2.3/16	55	2.3/16	55
T6260-3232	51	2	2" -11		-3232	9.45	240	5.31	135	5.20	132	2.3/4	70		

**NPTF**

**T6090**

NPTF MALE  
60° SEAT

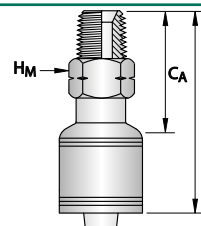

PART NO.	HOSE SIZE		THREAD SIZE	TUBE SIZE	DASH SIZE	DIMENSIONS						SPANNER			
	DN	inch	inch			L		CA		DL		HF		HM	
	DN	inch	inch			inch	mm	inch	mm	inch	mm	inch	mm	inch	mm
T6090-1212	19	3/4	3/4" -14		-1212	3.70	94	1.65	42					1.1/16	27
T6090-1616	25	1	1" -11,5		-1616	4.53	115	1.93	49					1.3/8	35
T6090-2020	31	1.1/4	1.1/4" -11,5		-2020	4.84	123	2.17	55					1.3/4	
T6090-2424	38	1.1/2	1.1/2" -11,5		-2424	5.67	144	2.20	56					2	50
T6090-3232	51	2	2" -11,5		-3232	6.93	176	2.80	71					2.1/2	

**NPTF**

**T6091**

NPTF MALE EXTENDED  
60° SEAT

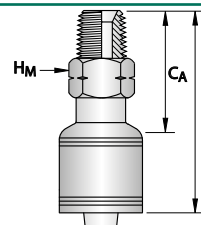

PART NO.	HOSE SIZE		THREAD SIZE	TUBE SIZE	DASH SIZE	DIMENSIONS						SPANNER			
	DN	inch	inch			L		CA		DL		HF		HM	
	DN	inch	inch			inch	mm	inch	mm	inch	mm	inch	mm	inch	mm
T6091-3232	51	2	2" -11,5		0 -3232	8.54	217	4.45	113						

## T6000 SERIES ONE-PIECE CRIMP COUPLINGS

### NPSM

### T6020N

NPSM FEMALE  
60° CONE

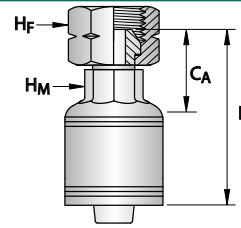

PART NO.	HOSE SIZE		THREAD SIZE	TUBE SIZE	DASH SIZE	DIMENSIONS				SPANNER					
	DN	inch	inch			L		C <sub>A</sub>		D <sub>L</sub>		H <sub>F</sub>		H <sub>M</sub>	
	DN	inch	inch			inch	mm	inch	mm			inch	mm	inch	mm
T6020N-1212	19	3/4	3/4" -14		-1212	3.23	82	1.18	30			1.1/4	32	1	
T6020N-1616	25	1	1" -11,5		-1616	4.02	102	1.46	37			1.1/2	38	1.3/8	35
T6020N-2020	31	1.1/4	1.1/4" -11,5		-2020	4.37	111	1.69	43			1.7/8		1.3/4	
T6020N-2424	38	1.1/2	1.1/2" -11,5		-2424	5.16	131	1.73	44			2.1/4	57	2	50
T6020N-3232	51	2	2" -11,5		-3232	6.46	164	2.32	59			2.3/4	70	2.1/2	

### JIC

### T6030

JIC 37°  
CONE MALE

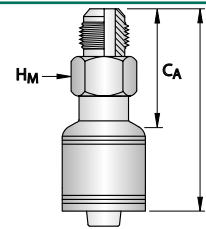

PART NO.	HOSE SIZE		THREAD SIZE	TUBE SIZE	DASH SIZE	DIMENSIONS				SPANNER					
	DN	inch	inch			L		C <sub>A</sub>		D <sub>L</sub>		H <sub>F</sub>		H <sub>M</sub>	
	DN	inch	inch			inch	mm	inch	mm			inch	mm	inch	mm
T6030-1621	25	1	1.5/16" -12		-1621	4.49	114	1.89	48					1.3/8	35
T6030-2026	31	1.1/4	1.5/8" -12		-2026	5.04	128	2.36	60					1.3/4	
T6030-2430	38	1.1/2	1.7/8" -12		-2430	5.75	146	2.28	58					2	50
T6030-3240	51	2	2.1/2" -12		-3240	7.20	183	3.11	79					2.1/2	

### JIC

### T6031

JIC  
37° CONE MALE  
METRIC HEX ONLY

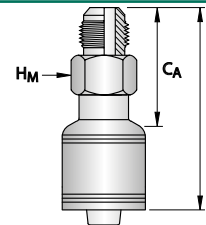

PART NO.	HOSE SIZE		THREAD SIZE	TUBE SIZE	DASH SIZE	DIMENSIONS				SPANNER					
	DN	inch	inch			L		C <sub>A</sub>		D <sub>L</sub>		H <sub>F</sub>		H <sub>M</sub>	
	DN	inch	inch			inch	mm	inch	mm			inch	mm	inch	mm
T6031-1621	25	1	1.5/16" -12		-1621	4.49	114	1.89	48						36

# ONE-PIECE COUPLINGS

## T6000 SERIES ONE-PIECE CRIMP COUPLINGS

### JSEAL™ / JIC

### T6040

JSEAL™ / JIC FEMALE  
CONVEX SEAT

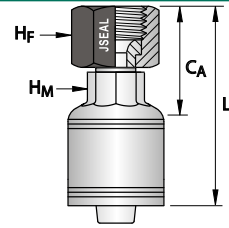

PART NO.	HOSE SIZE		THREAD SIZE	TUBE SIZE	DASH SIZE	DIMENSIONS						SPANNER			
	DN	inch	inch			L		C <sub>A</sub>		D <sub>L</sub>		H <sub>F</sub>		H <sub>M</sub>	
	inch	inch				inch	mm	inch	mm			inch	mm	inch	mm
T6040-1217	19	3/4	1.1/16" -12		-1217	3.37	86	1.32	34			1.1/4	32	1.1/6	27
T6040-1221	19	3/4	1.5/16" -12		-1221	3.50	89	1.45	37			1.1/2	38	1.1/16	27
T6040-1621	25	1	1.5/16" -12		-1621	4.09	104	1.50	38			1.1/2	38	1.3/8	35
T6040-1626	25	1	1.5/8" -12		-1626	4.25	108	1.65	42			2	50	1.5/8	41
T6040-2026	31	1.1/4	1.5/8" -12		-2026	4.45	113	1.77	45			2	50	1.3/4	
T6040-2030	31	1.1/4	1.7/8" -12		-2030	4.65	118	1.97	50			2.1/4	57	2	50
T6040-2430	38	1.1/2	1.7/8" -12		-2430	5.59	142	2.13	54			2.1/4	57	2.3/16	55
T6040-3240	51	2	2.1/2" -12		-3240	6.77	172	2.64	67			2.7/8	73	2.5/8	

### JIC

### T6045

JIC 37° FEMALE  
HIGH-PRESSURE

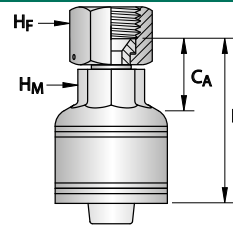

PART NO.	HOSE SIZE		THREAD SIZE	TUBE SIZE	DASH SIZE	DIMENSIONS						SPANNER			
	DN	inch	inch			L		C <sub>A</sub>		D <sub>L</sub>		H <sub>F</sub>		H <sub>M</sub>	
	inch	inch				inch	mm	inch	mm			inch	mm	inch	mm
T6045-1621	25	1	1.5/16" -12		-1621	3.96	101	1.38	35						

### JSEAL™ / JIC

### T6250

JSEAL™ / JIC FEMALE  
CONVEX SEAT  
45° TUBE BEND

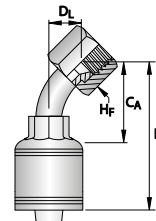

PART NO.	HOSE SIZE		THREAD SIZE	TUBE SIZE	DASH SIZE	DIMENSIONS						SPANNER			
	DN	inch	inch			L		C <sub>A</sub>		D <sub>L</sub>		H <sub>F</sub>		H <sub>M</sub>	
	inch	inch				inch	mm	inch	mm	inch	mm	inch	mm	inch	mm
T6250-1217	19	3/4	1.1/16" -12		-1217	4.84	123	2.80	71	1.10	28	1.1/4	32		
T6250-1621	25	1	1.5/16" -12		-1621	5.91	150	3.31	84	1.38	35	1.1/2	38		
T6250-2026	31	1.1/4	1.5/8" -12		-2026	6.69	170	4.02	102	1.54	39	2	50		
T6250-2430	38	1.1/2	1.7/8" -12		-2430	8.50	216	5.04	128	1.97	50	2.1/4	57	2.3/16	55
T6250-3240	51	2	2.1/2" -12		-3240	10.12	257	5.98	152	2.48	63	2.7/8	73		

## T6000 SERIES ONE-PIECE CRIMP COUPLINGS

### JSEAL™ / JIC

### T6280

JSEAL™ / JIC FEMALE  
CONVEX SEAT  
90° LONG TUBE BEND

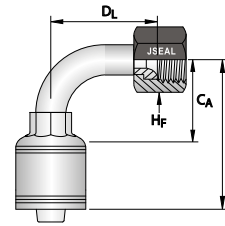

PART NO.	HOSE SIZE		THREAD SIZE	TUBE SIZE	DASH SIZE	DIMENSIONS						SPANNER		
	DN	inch	inch			L		CA		DL		HF		HM
	DN	inch	inch			inch	mm	inch	mm	inch	mm	inch	mm	
T6280-1217	19	3/4	1.1/16" -12		-1217	4.33	110	2.28	58	3.78	96	1.1/4	32	
T6280-1621	25	1	1.5/16" -12		-1621	5.55	141	2.95	75	4.49	114	1.1/2	38	
T6280-2026	31	1.1/4	1.5/8" -12		-2026	6.14	156	3.46	88	5.08	129	2	50	

### JSEAL™ / JIC

### T6240

JSEAL™ / JIC FEMALE  
CONVEX SEAT  
90° TUBE BEND

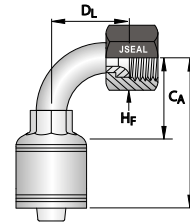

PART NO.	HOSE SIZE		THREAD SIZE	TUBE SIZE	DASH SIZE	DIMENSIONS						SPANNER			
	DN	inch	inch			L		CA		DL		HF		HM	
	DN	inch	inch			inch	mm	inch	mm	inch	mm	inch	mm	inch	mm
T6240-1217	19	3/4	1.1/16" -12		-1217	4.33	110	2.28	58	2.24	57	1.1/4	32		
T6240-1221	19	3/4	1.5/16" -12		-1221	4.33	110	2.28	58	2.80	71		38	1.1/2	
T6240-1621	25	1	1.5/16" -12		-1621	5.31	135	2.72	69	2.83	72	1.1/2	38		
T6240-2026	31	1.1/4	1.5/8" -12		-2026	6.14	156	3.46	88	3.19	81	2	50		
T6240-2430	38	1.1/2	1.7/8" -12		-2430	7.64	194	4.17	106	4.17	106	2.1/4	57	2.3/16	55
T6240-3240	51	2	2.1/2" -12		-3240	9.53	242	5.39	137	5.20	132	2.7/8	73		

### JOINER

### T6900

JOINER

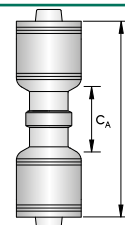

PART NO.	HOSE SIZE		THREAD SIZE	TUBE SIZE	DASH SIZE	DIMENSIONS				SPANNER		
	DN	inch		inch		L		CA		DL	HF	HM
	DN	inch		inch		inch	mm	inch	mm			
T6900-1212	19	3/4		3/4	-1212	2.83	72	0.79	20			
T6900-1616	25	1		1	-1616	3.70	94	1.14	29			
T6900-2020	31	1.1/4		1.1/4	-2020	3.78	96	1.10	28			
T6900-2424	38	1.1/2		1.1/2	-2424	4.53	115	1.10	28			
T6900-3232	51	2		2	-3232	5.55	141	1.42	36			

# ONE-PIECE COUPLINGS

## T6000 SERIES ONE-PIECE CRIMP COUPLINGS

### METRIC - DKS

### T6630

DKS MALE  
24° SEAT

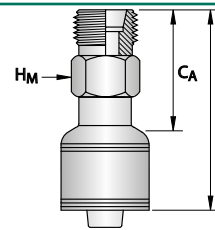

PART NO.	HOSE SIZE		THREAD SIZE	TUBE SIZE	DASH SIZE	DIMENSIONS				SPANNER					
	DN	inch				mm	mm	L		CA		DL		HF	
	DN	inch	mm	mm		inch	mm	inch	mm			inch	mm	inch	mm
T6630-1230	19	3/4	M 30X2	20	-1230	3.50	89	1.46	37					1.1/4	32
T6630-1236	19	3/4	M 36X2	25	-1236	3.58	91	1.54	39						36
T6630-1636	25	1	M 36X2	25	-1636	4.29	109	1.69	43					1.5/8	41
T6630-1642	25	1	M 42X2	30	-1642	4.37	111	1.77	45						46
T6630-2052	31	1.1/4	M 52X2	38	-2052	4.65	118	1.97	50					2.3/16	55
T6630-2452	38	1.1/2	M 52X2	38	-2452	5.39	137	1.97	50					2.3/16	55

### METRIC - DKOS

### T6711

DKOS FEMALE  
24° CONE

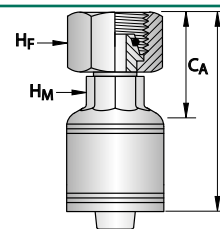

PART NO.	HOSE SIZE		THREAD SIZE	TUBE SIZE	DASH SIZE	DIMENSIONS				SPANNER						
	DN	inch				mm	mm			L		CA		DL		HF
	DN	inch	mm	mm		inch	mm	inch	mm			inch	mm	inch	mm	
T6711-1230	19	3/4	M 30X2	20	-1230	3.39	86	1.35	34					36	0	0
T6711-1236	19	3/4	M 36X2	25	-1236	3.46	88	1.42	36					46		
T6711-1636	25	1	M 36X2	25	-1636	4.02	102	1.42	36					46		
T6711-1642	25	1	M 42X2	30	-1642	4.09	104	1.50	38			2	50			
T6711-2052	31	1.1/4	M 52X2	38	-2052	4.29	109	1.61	41			2.3/8	60			
T6711-2452	38	1.1/2	M 52X2	38	-2452	5.08	129	1.65	42			2.3/8	60			

### METRIC - DKOS

### T6720

DKOS FEMALE  
24° CONE  
45° TUBE BEND

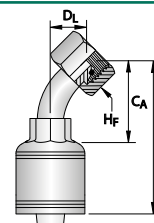

PART NO.	HOSE SIZE		THREAD SIZE	TUBE SIZE	DASH SIZE	DIMENSIONS				SPANNER						
	DN	inch				mm	mm			L		CA		DL		HF
	DN	inch	mm	mm		inch	mm	inch	mm	inch	mm	inch	mm	inch	mm	
T6720-1230	19	3/4	M 30X2	20	-1230	5.04	128	2.99	76	1.38	35			36	0	0
T6720-1236	19	3/4	M 36X2	25	-1236	5.04	128	2.99	76	1.38	35			46		
T6720-1642	25	1	M 42X2	30	-1642	6.10	155	3.50	89	1.46	37	2	50			
T6720-2052	31	1.1/4	M 52X2	38	-2052	7.72	196	5.04	128	1.89	48	2.3/8	60			
T6720-2452	38	1.1/2	M 52X2	38	-2452	8.54	217	5.08	129	1.89	48	2.3/8	60			

## T6000 SERIES ONE-PIECE CRIMP COUPLINGS

### METRIC - DKOS

### T6730

DKOS FEMALE  
24° CONE  
90° TUBE BEND

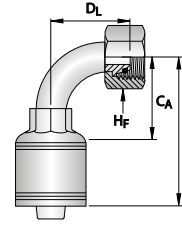

PART NO.	HOSE SIZE		THREAD SIZE	TUBE SIZE	DASH SIZE	DIMENSIONS						SPANNER			
	DN	inch	mm	mm		L		CA		DL		HF		HM	
	DN	inch	mm	mm		inch	mm	inch	mm	inch	mm	inch	mm	inch	mm
T6730-1230	19	3/4	M 30X2	20	-1230	4.37	111	2.32	59	2.68	68		36	0	0
T6730-1236	19	3/4	M 36X2	25	-1236	4.29	109	2.24	57	2.68	68		46		
T6730-1642	25	1	M 42X2	30	-1642	5.35	136	2.76	70	3.03	77	2	50		
T6730-2052	31	1.1/4	M 52X2	38	-2052	6.22	158	3.54	90	3.50	89	2.3/8	60		
T6730-2452	38	1.1/2	M 52X2	38	-2452	7.05	179	3.58	91	3.50	89	2.3/8	60		

### ORFS

### T6840

ORFS MALE

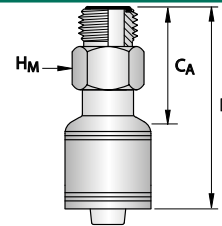

PART NO.	HOSE SIZE		THREAD SIZE	TUBE SIZE	DASH SIZE	DIMENSIONS						SPANNER			
	DN	inch	inch			L		CA		DL		HF		HM	
	DN	inch	inch			inch	mm	inch	mm			inch	mm	inch	mm
T6840-1219	19	3/4	1.3/16" - 12		-1219	3.66	93	1.61	41					1.1/4	32
T6840-1623	25	1	1.7/16" - 12		-1623	4.25	108	1.69	43					1.1/2	38
T6840-2027	31	1.1/4	1.11/16" - 12		-2027	4.76	121	2.09	53					1.43/50	47
T6840-2432	38	1.1/2	2" - 12		-2432	5.31	135	1.85	47					2.1/4	57

### ORFS

### T6800

ORFS FEMALE

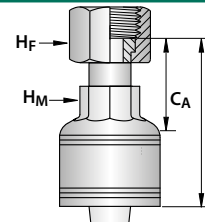

PART NO.	HOSE SIZE		THREAD SIZE	TUBE SIZE	DASH SIZE	DIMENSIONS						SPANNER			
	DN	inch	inch			L		CA		DL		HF		HM	
	DN	inch	inch			inch	mm	inch	mm			inch	mm	inch	mm
T6800-1219	19	3/4	1.3/16" - 12		-1219	3.78	96	1.73	44			1.3/8	35	1.1/8	
T6800-1223	19	3/4	1.7/16" - 12		-1223	4.17	106	2.13	54			1.5/8	41	1.3/8	35
T6800-1623	25	1	1.7/16" - 12		-1623	4.76	121	2.20	56			1.5/8	41	1.3/8	35
T6800-1627	25	1	1.11/16" - 12		-1627	4.96	126	2.40	61			2	50	1.3/4	
T6800-2027	31	1.1/4	1.11/16" - 12		-2027	5.08	129	2.40	61			2	50	1.3/4	
T6800-2432	38	1.1/2	2" - 12		-2432	6.18	157	2.72	69			2.1/4	57	2.1/4	57

# ONE-PIECE COUPLINGS

## T6000 SERIES ONE-PIECE CRIMP COUPLINGS

**ORFS**

**T6801**

ORFS FEMALE  
METRIC NUT ONLY

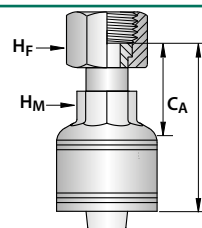

PART NO.	HOSE SIZE		THREAD SIZE	TUBE SIZE	DASH SIZE	DIMENSIONS						SPANNER				
	DN	inch	inch			L		C <sub>A</sub>		D <sub>L</sub>		H <sub>F</sub>		H <sub>M</sub>		
<b>T6801-1219</b>	19	3/4	1.3/16" - 12		-1219	3.78	96	1.73	44				36	1.1/8		

**ORFS**

**T6810**

ORFS FEMALE  
45° TUBE BEND

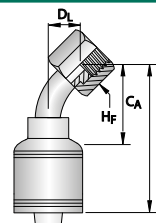

PART NO.	HOSE SIZE		THREAD SIZE	TUBE SIZE	DASH SIZE	DIMENSIONS						SPANNER			
	DN	inch	inch			L		C <sub>A</sub>		D <sub>L</sub>		H <sub>F</sub>		H <sub>M</sub>	
<b>T6810-1219</b>	19	3/4	1.3/16" - 12		-1219	4.65	118	2.60	66	1.14	29	1.3/8	35		
<b>T6810-1623</b>	25	1	1.7/16" - 12		-1623	6.02	153	3.43	87	1.34	34	1.5/8	41		
<b>T6810-2027</b>	31	1.1/4	1.11/16" - 12		-2027	6.97	177	4.29	109	1.77	45	2	50		
<b>T6810-2432</b>	38	1.1/2	2" - 12		-2432	8.46	215	5.00	127	2.09	53	2.1/4	57		

**ORFS**

**T6811**

ORFS FEMALE  
45° TUBE BEND  
METRIC NUT ONLY

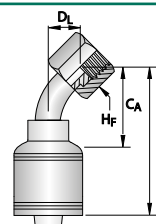

PART NO.	HOSE SIZE		THREAD SIZE	TUBE SIZE	DASH SIZE	DIMENSIONS						SPANNER			
	DN	inch	inch			L		C <sub>A</sub>		D <sub>L</sub>		H <sub>F</sub>		H <sub>M</sub>	
<b>T6811-1219</b>	19	3/4	1.3/16" - 12		-1219	4.65	118	2.60	66	1.14	29		36		

## T6000 SERIES ONE-PIECE CRIMP COUPLINGS

### ORFS

### T6820

ORFS FEMALE  
90° MEDIUM TUBE BEND

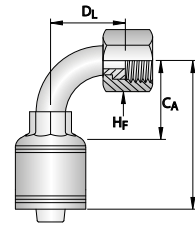

PART NO.	HOSE SIZE		THREAD SIZE	TUBE SIZE	DASH SIZE	DIMENSIONS						SPANNER			
	DN	inch	inch			L		C <sub>A</sub>		D <sub>L</sub>		H <sub>F</sub>		H <sub>M</sub>	
						inch	mm	inch	mm	inch	mm	inch	mm	inch	mm
<b>T6820-1219</b>	19	3/4	1.3/16" - 12		-1219	4.21	107	2.17	55	2.32	59	1.3/8	35		
<b>T6820-1223</b>	19	3/4	1.7/16" - 12		-1223	4.37	111	2.32	59	2.09	53	1.5/8	41	1.1/16	27
<b>T6820-1623</b>	25	1	1.7/16" - 12		-1623	5.39	137	2.80	71	2.80	71	1.5/8	41		
<b>T6820-2027</b>	31	1.1/4	1.11/16" - 12		-2027	6.18	157	3.50	89	3.54	90	2	50		
<b>T6820-2432</b>	38	1.1/2	2" - 12		-2432	7.64	194	4.17	106	4.21	107	2.1/4	57		

### ORFS

### T6821

ORFS FEMALE  
90° MEDIUM TUBE BEND  
METRIC NUT ONLY

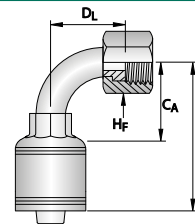

PART NO.	HOSE SIZE		THREAD SIZE	TUBE SIZE	DASH SIZE	DIMENSIONS						SPANNER			
	DN	inch	inch			L		C <sub>A</sub>		D <sub>L</sub>		H <sub>F</sub>		H <sub>M</sub>	
						inch	mm	inch	mm	inch	mm	inch	mm		
<b>T6821-1219</b>	19	3/4	1.3/16" - 12		-1219	4.21	107	2.17	55	2.32	59		36		

### RYCOLOK

### T6871

RYCOLOK MALE  
45° ELBOW- STAPLE  
O RING & BACK UP RING SUPPLIED

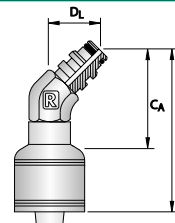

PART NO.	HOSE SIZE		THREAD SIZE	TUBE SIZE	DASH SIZE	DIMENSIONS						SPANNER			
	DN	inch	inch			L		C <sub>A</sub>		D <sub>L</sub>		H <sub>F</sub>		H <sub>M</sub>	
						inch	mm	inch	mm	inch	mm	inch	mm	inch	mm
<b>T6871-3250</b>	51	2		50	-3250	7.56	192	3.43	87	1.81	46			2.1/2	

# ONE-PIECE COUPLINGS

## T6000 SERIES ONE-PIECE CRIMP COUPLINGS

**RYCOLOK**

**T6872**

**RYCOLOK MALE  
90° ELBOW- STAPLE**  
O RING & BACK UP RING SUPPLIED

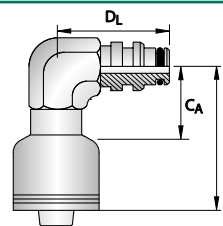

PART NO.	HOSE SIZE		THREAD SIZE	TUBE SIZE	DASH SIZE	DIMENSIONS						SPANNER	
	DN	inch		mm		L		C <sub>A</sub>		D <sub>L</sub>		H <sub>F</sub>	H <sub>M</sub>
<b>T6872-1220</b>	19	3/4		20	-1220	3.31	84	1.26	32	2.19	56		
<b>T6872-1625</b>	25	1		25	-1625	4.25	108	1.67	42	2.68	68		

**RYCOLOK**

**T6870**

**RYCOLOK  
MALE STAPLE**  
O RING & BACK UP RING SUPPLIED

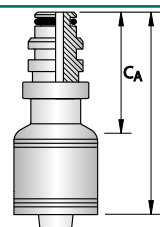

PART NO.	HOSE SIZE		THREAD SIZE	TUBE SIZE	DASH SIZE	DIMENSIONS						SPANNER	
	DN	inch	inch	mm		L		C <sub>A</sub>		D <sub>L</sub>		H <sub>F</sub>	H <sub>M</sub>
<b>T6870-1220</b>	19	3/4		20	-1220	3.66	93	1.61	41				
<b>T6870-1625</b>	25	1		25	-1625	4.53	115	1.93	49				
<b>T6870-2032</b>	31	1.1/4		32	-2032	4.72	120	2.05	52				
<b>T6870-2440</b>	38	1.1/2		40	-2440	5.83	148	2.40	61				
<b>T6870-3250</b>	51	2		50	-3250	6.57	167	2.48	63				

**RYCOLOK**

**T6876**

**RYCO SUPERLOK MALE  
STAPLE**  
O RING & BACK UP RING SUPPLIED

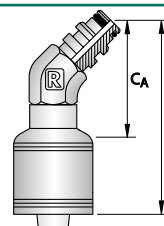

PART NO.	HOSE SIZE		THREAD SIZE	TUBE SIZE	DASH SIZE	DIMENSIONS						SPANNER	
	DN	inch		mm		L		C <sub>A</sub>		D <sub>L</sub>		H <sub>F</sub>	H <sub>M</sub>
<b>T6876-1220</b>	19	3/4		20	-1220	4.02	102	1.97	50				
<b>T6876-1625</b>	25	1		25	-1625	5.31	135	2.72	69				
<b>T6876-2032</b>	31	1.1/4		32	-2032	5.55	141	2.87	73				
<b>T6876-2440</b>	38	1.1/2		40	-2440	6.57	167	3.11	79				
<b>T6876-3250</b>	51	2		50	-3250	7.44	189	3.31	84				

## T6000 SERIES ONE-PIECE CRIMP COUPLINGS

### DIMENSIONS FOR SAE CODE 61 AND CODE 62 FLANGES, AND RYCO CODE 62C FLANGES

NOMINAL FLANGE	CODE 61				CODE 62				CODE 62C			
	B		T		B		T		B		T	
inch	mm	inch	mm	inch	mm	inch	mm	inch	mm	inch	mm	inch
1/2	30,2	1.19	6,73	0.265	31,8	1.25	7,75	0.305				
5/8	34,0	1.34	6,73	0.265								
3/4	38,1	1.50	6,73	0.265	41,3	1.63	8,76	0.345	41,3	1.63	14,20	0.559
1	44,5	1.75	8,00	0.315	47,6	1.88	9,53	0.375	47,6	1.88	14,20	0.559
1.1/4	50,8	2.00	8,00	0.315	54,0	2.12	10,29	0.405	54,0	2.12	14,20	0.559
1.1/2	60,3	2.38	8,00	0.315	63,5	2.50	12,57	0.495	63,5	2.50	14,20	0.559
2	71,4	2.81	9,53	0.375	79,4	3.13	12,57	0.495	79,4	3.13	14,20	0.559
2.1/2	84,1	3.31	9,53	0.375								
3	101,6	4.00	9,53	0.375								

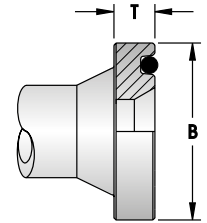

**NOTE:** Ryco Code 62C fittings conform to the flange OD and bolt hole patterns of SAE Code 62 but require special flange clamps. Ryco Code 62C flange heads are thicker than SAE Code 62 and measure T = 14,2 mm (0.559 inch) in all sizes.

### SAE FLANGE

### T6130

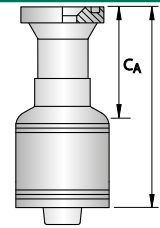

#### SAE CODE 61 FLANGE

PART NO.	HOSE SIZE		THREAD SIZE	TUBE SIZE	DASH SIZE	DIMENSIONS				SPANNER	
	DN	inch				L		C <sub>A</sub>		D <sub>L</sub>	H <sub>F</sub>
						inch	mm	inch	mm		
T6130-1212	19	3/4			-1212	3.94	100	1.89	48		
T6130-1216	19	3/4			-1216	4.09	104	2.05	52		
T6130-1616	25	1			-1616	4.69	119	2.09	53		
T6130-1620	25	1			-1620	4.88	124	2.28	58		
T6130-2020	31	1.1/4			-2020	5.08	129	2.40	61		
T6130-2424	38	1.1/2			-2424	6.85	174	3.43	87		
T6130-3232	51	2			-3232	8.11	206	3.98	101		

INTRODUCTION

INDEXES

ONE-PIECE COUPLINGS

PUSH-ON SUCTION & RETURN COUPLINGS

FIELD ATTACHABLE COUPLINGS

HYDRAULIC FITTINGS ACCESSORIES

# ONE-PIECE COUPLINGS

## T6000 SERIES ONE-PIECE CRIMP COUPLINGS

### SAE FLANGE

### T6290

SAE CODE 61 FLANGE  
30° TUBE BEND  
O RING NOT SUPPLIED

CLAMPS - SEE PAGES 274 & 282

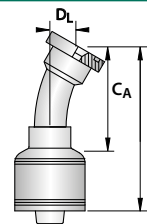

PART NO.	HOSE SIZE		THREAD SIZE	TUBE SIZE	DASH SIZE	DIMENSIONS						SPANNER	
	DN	inch				L		C <sub>A</sub>		D <sub>L</sub>		H <sub>F</sub>	H <sub>M</sub>
					inch	mm	inch	mm	inch	mm			
T6290-1212	19	3/4			-1212	4.88	124	2.83	72	0.71	18		
T6290-1616	25	1			-1616	6.30	160	3.70	94	0.87	22		
T6290-2020	31	1.1/4			-2020	6.85	174	4.17	106	0.79	20		
T6290-2024	31	1.1/4			-2024	7.05	179	4.37	111	0.94	24		
T6290-2424	38	1.1/2			-2424	8.11	206	4.65	118	1.02	26		
T6290-2432	38	1.1/2			-2432	8.58	218	5.12	130	1.26	32		
T6290-3232	51	2			-3232	10.20	259	6.06	154	1.57	40		

### SAE FLANGE

### T6150

SAE CODE 61 FLANGE  
45° TUBE BEND  
O RING NOT SUPPLIED

CLAMPS - SEE PAGES 274 & 282

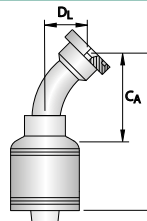

PART NO.	HOSE SIZE		THREAD SIZE	TUBE SIZE	DASH SIZE	DIMENSIONS						SPANNER	
	DN	inch				L		C <sub>A</sub>		D <sub>L</sub>		H <sub>F</sub>	H <sub>M</sub>
					inch	mm	inch	mm	inch	mm			
T6150-1212	19	3/4			-1212	4.72	120	2.68	68	1.02	26		
T6150-1216	19	3/4			-1216	4.80	122	2.76	70	1.18	30		
T6150-1616	25	1			-1616	5.87	149	3.27	83	1.18	30		
T6150-1620	25	1			-1620	5.94	151	3.35	85	1.26	32		
T6150-2020	31	1.1/4			-2020	6.69	170	4.02	102	1.50	38		
T6150-2424	38	1.1/2			-2424	8.03	204	4.57	116	1.65	42		
T6150-3232	51	2			-3232	10.04	255	5.91	150	2.28	58		

## T6000 SERIES ONE-PIECE CRIMP COUPLINGS

### SAE FLANGE

### T6300

CODE 61 FLANGE  
60° TUBE BEND  
O RING NOT SUPPLIED

CLAMPS - SEE PAGES 274 & 282

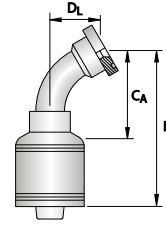

PART NO.	HOSE SIZE		THREAD SIZE	TUBE SIZE	DASH SIZE	DIMENSIONS						SPANNER	
	DN	inch				L		C <sub>A</sub>		D <sub>L</sub>		H <sub>F</sub>	H <sub>M</sub>
					inch	mm	inch	mm	inch	mm			
T6300-1212	19	3/4			-1212	5.20	132	3.15	80	1.46	37		
T6300-1216	19	3/4			-1216	5.28	134	3.23	82	1.61	41		
T6300-1616	25	1			-1616	6.50	165	3.90	99	1.81	46		
T6300-1620	25	1			-1620	6.42	163	3.82	97	1.77	45		
T6300-2020	31	1.1/4			-2020	7.36	187	4.69	119	2.01	51		
T6300-2024	31	1.1/4			-2024	7.44	189	4.76	121	2.13	54		
T6300-2424	38	1.1/2			-2424	9.13	232	5.67	144	2.36	60		
T6300-2432	38	1.1/2			-2432	9.25	235	5.79	147	2.68	68		
T6300-3232	51	2			-3232	11.46	291	7.32	186	3.23	82		

### SAE

### T6170

CODE 61 FLANGE  
90° TUBE BEND  
O RING NOT SUPPLIED

CLAMPS - SEE PAGES 274 & 282

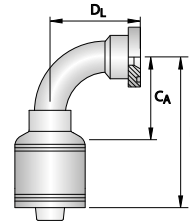

PART NO.	HOSE SIZE		THREAD SIZE	TUBE SIZE	DASH SIZE	DIMENSIONS						SPANNER	
	DN	inch				inch	inch	mm	inch	mm	inch	mm	H <sub>F</sub>
T6170-1212	19	3/4		-	-1212	4.33	110	2.28	58	2.13	54		
T6170-1216	19	3/4		-	-1216	4.29	109	2.24	57	2.36	60		
T6170-1616	25	1		-	-1616	5.35	136	2.76	70	2.68	68		
T6170-1620	25	1		-	-1620	5.35	136	2.76	70	2.72	69		
T6170-2020	31	1.1/4		-	-2020	6.22	158	3.54	90	3.07	78		
T6170-2424	38	1.1/2		-	-2424	7.56	192	4.09	104	3.66	93		
T6170-3232	51	2		-	-3232	9.53	242	5.39	137	5.12	130		

# ONE-PIECE COUPLINGS

## T6000 SERIES ONE-PIECE CRIMP COUPLINGS

### SAE FLANGE

### T6330

CODE 62 FLANGE  
O RING NOT SUPPLIED

CLAMPS - SEE PAGES 274 & 282

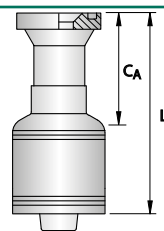

PART NO.	HOSE SIZE		THREAD SIZE	TUBE SIZE	DASH SIZE	DIMENSIONS				SPANNER			
	DN	inch				L		CA		DL	HF		HM
					inch	mm	inch	mm					
T6330-1212	19	3/4			-1212	4.13	105	2.09	53				
T6330-1216	19	3/4			-1216	4.25	108	2.20	56				
T6330-1612	25	1			-1612	4.72	120	2.17	55				
T6330-1616	25	1			-1616	4.84	123	2.24	57				
T6330-1620	25	1			-1620	5.28	134	2.72	69				
T6330-2016	31	1.1/4			-2016	5.47	139	2.80	71				
T6330-2020	31	1.1/4			-2020	5.47	139	2.80	71				
T6330-2024	31	1.1/4			-2024	6.65	169	3.98	101				
T6330-2420	38	1.1/2			-2420	6.22	158	2.76	70				
T6330-2424	38	1.1/2			-2424	7.40	188	3.98	101				
T6330-2432	38	1.1/2			-2432	8.11	206	4.69	119				
T6330-3224	51	2			-3224	8.31	211	4.21	107				
T6330-3232	51	2			-3232	8.98	228	4.84	123				

### SAE FLANGE

### T6333

RYCO CODE 62C FLANGE  
O RING NOT SUPPLIED

CLAMPS - SEE PAGES 274 & 282

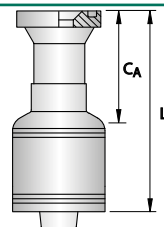

PART NO.	HOSE SIZE		THREAD SIZE	TUBE SIZE	DASH SIZE	DIMENSIONS				SPANNER			
	DN	inch				L		CA		DL	HF		HM
					inch	mm	inch	mm					
T6333-1212	19	3/4			-1212	5.51	140	3.46	88				
T6333-1216	19	3/4			-1216	5.51	140	3.46	88				
T6333-1616	25	1			-1616	6.14	156	3.54	90				
T6333-1620	25	1			-1620	6.14	156	3.54	90				
T6333-2020	31	1.1/4			-2020	6.18	157	3.50	89				
T6333-2024	31	1.1/4			-2024	6.18	157	3.50	89				
T6333-2424	38	1.1/2			-2424	6.89	175	3.43	87				
T6333-3232	51	2			-3232	8.46	215	4.37	111				

## T6000 SERIES ONE-PIECE CRIMP COUPLINGS

### SAE FLANGE

### T6334

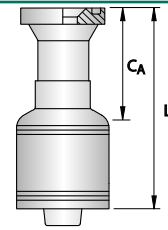

**RYCO CODE 62C D-RING FLANGE**

O RING NOT SUPPLIED

CLAMPS - SEE PAGES 274 & 282

PART NO.	HOSE SIZE		THREAD SIZE	TUBE SIZE	DASH SIZE	DIMENSIONS				SPANNER			
	DN	inch				L		CA		DL	HF	HM	
	DN	inch				inch	mm	inch	mm				
<b>T6334-1212</b>	19	3/4			-1212	4.57	116	2.52	64				
<b>T6334-1216</b>	19	3/4			-1216	4.57	116	2.52	64				
<b>T6334-1616</b>	25	1			-1616	5.16	131	2.56	65				
<b>T6334-1620</b>	25	1			-1620	5.47	139	2.87	73				
<b>T6334-2020</b>	31	1.1/4			-2020	6.34	161	3.66	93				
<b>T6334-2024</b>	31	1.1/4			-2024	6.18	157	3.50	89				
<b>T6334-2424</b>	38	1.1/2			-2424	6.77	172	3.31	84				
<b>T6334-3232</b>	51	2			-3232	9.02	229	4.92	125				

### CODE 62

### T6335

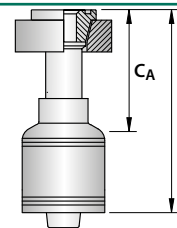

**RYCO CODE 62K FLANGE**

O RING NOT SUPPLIED

CLAMPS - SEE PAGES 274 & 282

PART NO.	HOSE SIZE		THREAD SIZE	TUBE SIZE	DASH SIZE	DIMENSIONS				SPANNER			
	DN	inch				L		CA		DL	HF	HM	
	DN	inch				inch	mm	inch	mm				
<b>T6335-1616</b>	25	1			-1616	5.04	128	2.44	62				
<b>T6335-1620</b>	25	1			-1620	4.80	122	2.20	56				
<b>T6335-2016</b>	31	1.1/4			-2016	7.20	183	4.53	115				
<b>T6335-2020</b>	31	1.1/4			-2020	6.42	163	3.74	95				
<b>T6335-2024</b>	31	1.1/4			-2024	5.83	148	3.15	80				
<b>T6335-2424</b>	38	1.1/2			-2424	7.68	195	4.21	107				
<b>T6335-2432</b>	38	1.1/2			-2432	7.05	179	3.62	92				
<b>T6335-3224</b>	51	2			-3224	9.92	252	5.79	147				
<b>T6335-3232</b>	51	2			-3232	8.94	227	4.80	122				

INTRODUCTION

INDEXES

ONE-PIECE COUPLINGS

PUSH-ON SUCTION & RETURN COUPLINGS

FIELD ATTACHABLE COUPLINGS

HYDRAULIC FITTINGS ACCESSORIES

# ONE-PIECE COUPLINGS

## T6000 SERIES ONE-PIECE CRIMP COUPLINGS

### SAE FLANGE

### T6912

RYCO CODE 62K FLANGE  
15° TUBE BEND  
O RING NOT SUPPLIED

CLAMPS - SEE PAGES 274 & 282

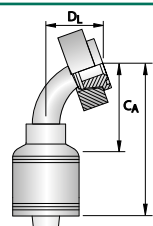

PART NO.	HOSE SIZE		THREAD SIZE	TUBE SIZE	DASH SIZE	DIMENSIONS						SPANNER	
	DN	inch				L		C <sub>A</sub>		D <sub>L</sub>		H <sub>F</sub>	H <sub>M</sub>
	DN	inch				inch	mm	inch	mm	inch	mm		
T6912-1616	25	1			-1616	7.52	191	4.92	125	0.67	17		
T6912-2024	31	1.1/4			-2024	9.21	234	6.54	166	0.71	18		
T6912-2424	38	1.1/2			-2424	11.06	281	7.64	194	0.94	24		
T6912-2432	38	1.1/2			-2432	11.10	282	7.68	195	1.06	27		

### SAE FLANGE

### T6440

SAE CODE 62 FLANGE  
22.5° TUBE BEND  
O RING NOT SUPPLIED

CLAMPS - SEE PAGES 274 & 282

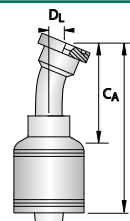

PART NO.	HOSE SIZE		THREAD SIZE	TUBE SIZE	DASH SIZE	DIMENSIONS						SPANNER	
	DN	inch				L		C <sub>A</sub>		D <sub>L</sub>		H <sub>F</sub>	H <sub>M</sub>
	DN	inch				inch	mm	inch	mm	inch	mm		
T6440-1212	19	3/4			-1212	5.20	132	3.15	80	0.63	16		
T6440-1216	19	3/4			-1216	5.16	131	3.11	79	0.55	14		
T6440-1616	25	1			-1616	6.18	157	3.58	91	0.63	16		
T6440-2020	31	1.1/4			-2020	7.01	178	4.33	110	0.67	17		
T6440-2024	31	1.1/4			-2024	7.32	186	4.65	118	0.87	22		
T6440-2424	38	1.1/2			-2424	8.46	215	5.00	127	0.94	24		
T6440-3232	51	2			-3232	10.71	272	6.57	167	1.10	28		

### SAE FLANGE

### T6445

RYCO CODE 62K FLANGE  
22.5° TUBE BEND  
O RING NOT SUPPLIED

CLAMPS - SEE PAGES 274 & 282

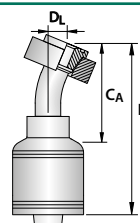

PART NO.	HOSE SIZE		THREAD SIZE	TUBE SIZE	DASH SIZE	DIMENSIONS						SPANNER	
	DN	inch				L		C <sub>A</sub>		D <sub>L</sub>		H <sub>F</sub>	H <sub>M</sub>
	DN	inch				inch	mm	inch	mm	inch	mm		
T6445-3232	51	2			-3232	12.76	324	8.62	219	1.77	45		

## T6000 SERIES ONE-PIECE CRIMP COUPLINGS

### SAE FLANGE

### T6443

RYCO CODE 62C FLANGE  
22.5° TUBE BEND  
O RING NOT SUPPLIED

CLAMPS - SEE PAGES 274 & 282

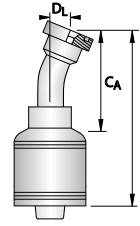

PART NO.	HOSE SIZE		THREAD SIZE	TUBE SIZE	DASH SIZE	DIMENSIONS						SPANNER	
	DN	inch				L		C <sub>A</sub>		D <sub>L</sub>		H <sub>F</sub>	H <sub>M</sub>
						inch	mm	inch	mm	inch	mm		
T6443-1212	19	3/4			-1212	5.28	134	3.23	82	0.71	18		
T6443-1216	19	3/4			-1216	5.39	137	3.35	85	0.79	20		
T6443-1616	25	1			-1616	6.34	161	3.74	95	0.63	16		
T6443-1620	25	1			-1620	6.38	162	3.78	96	0.75	19		
T6443-2020	31	1.1/4			-2020	7.17	182	4.49	114	0.75	19		
T6443-2024	31	1.1/4			-2024	7.32	186	4.65	118	0.87	22		
T6443-2424	38	1.1/2			-2424	8.46	215	5.00	127	0.94	24		
T6440-3232	51	2			-3232	10.71	272	6.57	167	1.10	28		

### SAE FLANGE

### T6444

RYCO CODE 62C D-RING FLANGE  
22.5° TUBE BEND  
O RING NOT SUPPLIED

CLAMPS - SEE PAGES 274 & 282

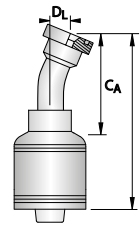

PART NO.	HOSE SIZE		THREAD SIZE	TUBE SIZE	DASH SIZE	DIMENSIONS						SPANNER	
	DN	inch				L		C <sub>A</sub>		D <sub>L</sub>		H <sub>F</sub>	H <sub>M</sub>
						inch	mm	inch	mm	inch	mm		
T6444-1212	19	3/4			-1212	5.24	133	3.19	81	0.59	15		
T6444-1616	25	1			-1616	6.10	155	3.50	89	0.63	16		
T6444-1620	25	1			-1620	4.17	106	1.61	41	0.63	16		
T6444-2020	31	1.1/4			-2020	7.17	182	4.49	114	0.75	19		

INTRODUCTION

INDEXES

ONE-PIECE  
COUPLINGS

PUSH-ON SUCTION &  
RETURN COUPLINGS

FIELD ATTACHABLE  
COUPLINGS

HYDRAULIC FITTINGS  
ACCESSORIES

# ONE-PIECE COUPLINGS

## T6000 SERIES ONE-PIECE CRIMP COUPLINGS

### SAE FLANGE

### T6450

SAE CODE 62 FLANGE  
30° TUBE BEND  
O RING NOT SUPPLIED

CLAMPS - SEE PAGES 274 & 282

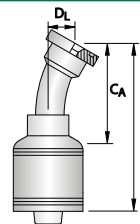

PART NO.	HOSE SIZE		THREAD SIZE	TUBE SIZE	DASH SIZE	DIMENSIONS						SPANNER	
	DN	inch				L		C <sub>A</sub>		D <sub>L</sub>		H <sub>F</sub>	H <sub>M</sub>
					inch	mm	inch	mm	inch	mm			
T6450-1212	19	3/4			-1212	4.92	125	2.87	73	0.75	19		
T6450-1616	25	1			-1616	6.14	156	3.54	90	0.87	22		
T6450-1620	25	1			-1620	6.14	156	3.54	90	0.98	25		
T6450-2020	31	1.1/4			-2020	7.01	178	4.33	110	0.87	22		
T6450-2024	31	1.1/4			-2024	7.20	183	4.53	115	0.98	25		
T6450-2424	38	1.1/2			-2424	8.78	223	5.31	135	1.30	33		
T6450-3232	51	2			-3232	10.67	271	6.54	166	1.57	40		

### SPECIAL FLANGE

### T6453

RYCO CODE 62C FLANGE  
30° TUBE BEND  
O RING NOT SUPPLIED

CLAMPS - SEE PAGES 274 & 282

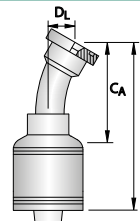

PART NO.	HOSE SIZE		THREAD SIZE	TUBE SIZE	DASH SIZE	DIMENSIONS						SPANNER	
	DN	inch				L		C <sub>A</sub>		D <sub>L</sub>		H <sub>F</sub>	H <sub>M</sub>
					inch	mm	inch	mm	inch	mm			
T6453-1212	19	3/4			-1212	5.16	131	3.11	79	0.91	23		
T6453-1616	25	1			-1616	6.97	177	4.37	111	0.94	24		
T6453-1620	25	1			-1620	7.09	180	4.49	114	0.98	25		
T6453-2020	31	1.1/4			-2020	7.32	186	4.65	118	0.98	25		
T6453-2024	31	1.1/4			-2024	7.28	185	4.61	117	1.02	26		
T6453-2424	38	1.1/2			-2424	8.46	215	5.00	127	1.18	30		

## T6000 SERIES ONE-PIECE CRIMP COUPLINGS

### SPECIAL FLANGE

### T6454

RYCO CODE 62C D-RING FLANGE  
30° TUBE BEND  
O RING NOT SUPPLIED

CLAMPS - SEE PAGES 274 & 282

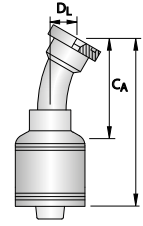

PART NO.	HOSE SIZE		THREAD SIZE	TUBE SIZE	DASH SIZE	DIMENSIONS						SPANNER	
	DN	inch				L		C <sub>A</sub>		D <sub>L</sub>		H <sub>F</sub>	H <sub>M</sub>
						inch	mm	inch	mm	inch	mm		
<b>T6454-1212</b>	19	3/4			-1212	5.28	134	3.23	82	0.91	23		
<b>T6454-1616</b>	25	1			-1616	6.85	174	4.25	108	0.94	24		
<b>T6454-2020</b>	31	1.1/4			-2020	7.28	185	4.61	117	0.98	25		
<b>T6454-2024</b>	31	1.1/4			-2024	7.28	185	4.61	117	1.02	26		

### SPECIAL FLANGE

### T6455

RYCO CODE 62K FLANGE  
30° TUBE BEND  
O RING NOT SUPPLIED

CLAMPS - SEE PAGES 274 & 282

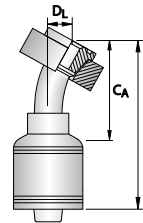

PART NO.	HOSE SIZE		THREAD SIZE	TUBE SIZE	DASH SIZE	DIMENSIONS						SPANNER	
	DN	inch				L		C <sub>A</sub>		D <sub>L</sub>		H <sub>F</sub>	H <sub>M</sub>
						inch	mm	inch	mm	inch	mm		
<b>T6455-2020</b>	31	1.1/4			-2020	9.41	239	6.73	171	1.57	40		
<b>T6455-2024</b>	31	1.1/4			-2024	9.21	234	6.54	166	1.50	38		
<b>T6455-2424</b>	38	1.1/2			-2424	10.67	271	7.24	184	1.97	50		
<b>T6455-3232</b>	51	2			-3232	12.52	318	8.39	213	2.17	55		

INTRODUCTION

INDEXES

ONE-PIECE COUPLINGS

PUSH-ON SUCTION & RETURN COUPLINGS

FIELD ATTACHABLE COUPLINGS

HYDRAULIC FITTINGS ACCESSORIES

# ONE-PIECE COUPLINGS

## T6000 SERIES ONE-PIECE CRIMP COUPLINGS

### SPECIAL FLANGE

### T6350

SAE CODE 62 FLANGE  
45° TUBE BEND  
O RING NOT SUPPLIED

CLAMPS - SEE PAGES 274 & 282

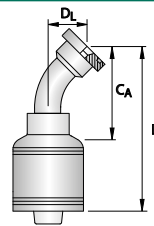

PART NO.	HOSE SIZE		THREAD SIZE	TUBE SIZE	DASH SIZE	DIMENSIONS						SPANNER	
	DN	inch				L		C <sub>A</sub>		D <sub>L</sub>		H <sub>F</sub>	H <sub>M</sub>
						inch	mm	inch	mm	inch	mm		
<b>T6350-1212</b>	19	3/4			-1212	4.76	121	2.72	69	1.10	28		
<b>T6350-1216</b>	19	3/4			-1216	4.92	125	2.87	73	1.22	31		
<b>T6350-1612</b>	25	1			-1612	5.43	138	2.83	72	1.10	28		
<b>T6350-1616</b>	25	1			-1616	5.91	150	3.31	84	1.22	31		
<b>T6350-1620</b>	25	1			-1620	5.94	151	3.35	85	1.34	34		
<b>T6350-2020</b>	31	1.1/4			-2020	6.73	171	4.06	103	1.50	38		
<b>T6350-2024</b>	31	1.1/4			-2024	6.85	174	4.17	106	1.61	41		
<b>T6350-2424</b>	38	1.1/2			-2424	7.91	201	4.45	113	1.77	45		
<b>T6350-2432</b>	38	1.1/2			-2432	8.23	209	4.76	121	1.97	50		
<b>T6350-3232</b>	51	2			-3232	10.24	260	6.10	155	2.36	60		

### SPECIAL FLANGE

### T6353

RYCO CODE 62C FLANGE  
45° TUBE BEND  
O RING NOT SUPPLIED

CLAMPS - SEE PAGES 274 & 282

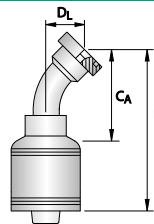

PART NO.	HOSE SIZE		THREAD SIZE	TUBE SIZE	DASH SIZE	DIMENSIONS						SPANNER	
	DN	inch				L		C <sub>A</sub>		D <sub>L</sub>		H <sub>F</sub>	H <sub>M</sub>
						inch	mm	inch	mm	inch	mm		
<b>T6353-1212</b>	19	3/4			-1212	4.88	124	2.83	72	1.22	31		
<b>T6353-1216</b>	19	3/4			-1216	4.88	124	2.83	72	1.30	33		
<b>T6353-1616</b>	25	1			-1616	6.02	153	3.43	87	1.38	35		
<b>T6353-1620</b>	25	1			-1620	5.91	150	3.31	84	1.46	37		
<b>T6353-2020</b>	31	1.1/4			-2020	6.85	174	4.17	106	1.61	41		
<b>T6353-2024</b>	31	1.1/4			-2024	7.01	178	4.33	110	1.65	42		
<b>T6353-2424</b>	38	1.1/2			-2424	11.81	300	8.39	213	1.81	46		
<b>T6353-3232</b>	51	2			-3232	10.47	266	6.34	161	2.40	61		

## T6000 SERIES ONE-PIECE CRIMP COUPLINGS

### SPECIAL FLANGE

### T6354

RYCO CODE 62C D-RING FLANGE  
45° TUBE BEND  
O RING NOT SUPPLIED

CLAMPS - SEE PAGES 274 & 282

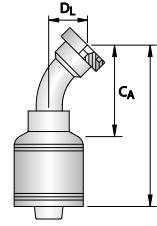

PART NO.	HOSE SIZE		THREAD SIZE	TUBE SIZE	DASH SIZE	DIMENSIONS						SPANNER	
	DN	inch				L		C <sub>A</sub>		D <sub>L</sub>		H <sub>F</sub>	H <sub>M</sub>
						inch	mm	inch	mm	inch	mm		
T6354-1212	19	3/4			-1212	4.84	123	2.80	71	1.22	31		
T6354-1216	19	3/4			-1216	4.96	126	2.91	74	1.30	33		
T6354-1616	25	1			-1616	6.18	157	3.58	91	1.38	35		
T6354-1620	25	1			-1620	5.83	148	3.23	82	1.46	37		
T6354-2020	31	1.1/4			-2020	6.85	174	4.17	106	1.61	41		
T6354-2024	31	1.1/4			-2024	7.01	178	4.33	110	1.69	43		

### SPECIAL FLANGE

### T6355

RYCO CODE 62K FLANGE  
45° TUBE BEND  
O RING NOT SUPPLIED

CLAMPS - SEE PAGES 274 & 282

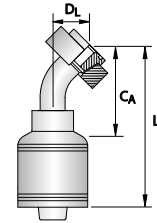

PART NO.	HOSE SIZE		THREAD SIZE	TUBE SIZE	DASH SIZE	DIMENSIONS						SPANNER	
	DN	inch				L		C <sub>A</sub>		D <sub>L</sub>		H <sub>F</sub>	H <sub>M</sub>
						inch	mm	inch	mm	inch	mm		
T6355-1616	25	1			-1616	6.85	174	4.25	108	1.97	50		
T6355-1620	25	1			-1620	6.81	173	4.21	107	1.97	50		
T6355-2016	31	1.1/4			-2016	8.70	221	6.02	153	2.17	55		
T6355-2020	31	1.1/4			-2020	8.90	226	6.22	158	2.36	60		
T6355-2024	31	1.1/4			-2024	9.29	236	6.61	168	2.36	60		
T6355-2420	38	1.1/2			-2420	9.65	245	6.20	158	2.87	73		
T6355-2424	38	1.1/2			-2424	10.00	254	6.57	167	3.15	80		
T6355-2432	38	1.1/2			-2432	9.65	245	6.22	158	3.74	95		
T6355-3224	51	2			-3224	11.38	289	7.28	185	3.35	85		
T6355-3232	51	2			-3232	11.73	298	7.60	193	3.54	90		

INTRODUCTION

INDEXES

ONE-PIECE COUPLINGS

PUSH-ON SUCTION & RETURN COUPLINGS

FIELD ATTACHABLE COUPLINGS

HYDRAULIC FITTINGS ACCESSORIES

# ONE-PIECE COUPLINGS

## T6000 SERIES ONE-PIECE CRIMP COUPLINGS

### SPECIAL FLANGE

### T6359

RYCO CODE 62K D-RING FLANGE  
45° TUBE BEND  
O RING NOT SUPPLIED

CLAMPS - SEE PAGES 274 & 282

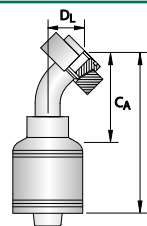

PART NO.	HOSE SIZE		THREAD SIZE	TUBE SIZE	DASH SIZE	DIMENSIONS						SPANNER	
	DN	inch				L		C <sub>A</sub>		D <sub>L</sub>		H <sub>F</sub>	H <sub>M</sub>
	DN	inch				inch	mm	inch	mm	inch	mm		
<b>T6359-3232</b>	51	2			-3232	13.90	353	9.76	248	5.31	135		

### SPECIAL FLANGE

### T6465

RYCO CODE 62K FLANGE  
60° TUBE BEND  
O RING NOT SUPPLIED

CLAMPS - SEE PAGES 274 & 282

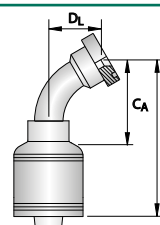

PART NO.	HOSE SIZE		THREAD SIZE	TUBE SIZE	DASH SIZE	DIMENSIONS						SPANNER	
	DN	inch				L		C <sub>A</sub>		D <sub>L</sub>		H <sub>F</sub>	H <sub>M</sub>
	DN	inch				inch	mm	inch	mm	inch	mm		
<b>T6465-2424</b>	38	1.1/2			-2424	11.30	287	7.87	200	3.70	94		
<b>T6465-3232</b>	51	2			-3232	13.62	346	9.49	241	4.72	120		

### SPECIAL FLANGE

### T6360

SAE CODE 62 FLANGE  
67.5° TUBE BEND  
O RING NOT SUPPLIED

CLAMPS - SEE PAGES 274 & 282

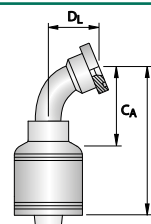

PART NO.	HOSE SIZE		THREAD SIZE	TUBE SIZE	DASH SIZE	DIMENSIONS						SPANNER	
	DN	inch				L		C <sub>A</sub>		D <sub>L</sub>		H <sub>F</sub>	H <sub>M</sub>
	DN	inch				inch	mm	inch	mm	inch	mm		
<b>T6360-1212</b>	19	3/4			-1212	4.96	126	2.91	74	1.85	47		
<b>T6360-1216</b>	19	3/4			-1216	5.08	129	3.03	77	1.73	44		
<b>T6360-1616</b>	25	1			-1616	6.18	157	3.58	91	2.01	51		
<b>T6360-1620</b>	25	1			-1620	6.34	161	3.74	95	2.83	72		
<b>T6360-2020</b>	31	1.1/4			-2020	7.95	202	5.28	134	2.83	72		
<b>T6360-2024</b>	31	1.1/4			-2024	8.11	206	5.43	138	2.91	74		

## T6000 SERIES ONE-PIECE CRIMP COUPLINGS

### SPECIAL FLANGE

### T6914

RYCO CODE 62K FLANGE  
70° TUBE BEND  
O RING NOT SUPPLIED

CLAMPS - SEE PAGES 274 & 282

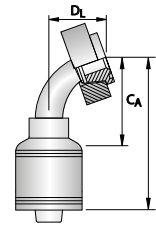

PART NO.	HOSE SIZE		THREAD SIZE	TUBE SIZE	DASH SIZE	DIMENSIONS						SPANNER	
	DN	inch				L		C <sub>A</sub>		D <sub>L</sub>		H <sub>F</sub>	H <sub>M</sub>
						inch	mm	inch	mm	inch	mm		
<b>T6914-1616</b>	25	1			-1616	7.13	181	4.53	115	2.76	70		
<b>T6914-2020</b>	31	1.1/4			-2020	9.33	237	6.65	169	3.78	96		

### SPECIAL FLANGE

### T6916

RYCO CODE 62K FLANGE  
75° TUBE BEND  
O RING NOT SUPPLIED

CLAMPS - SEE PAGES 274 & 282

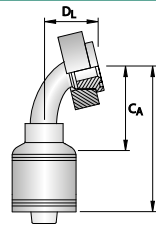

PART NO.	HOSE SIZE		THREAD SIZE	TUBE SIZE	DASH SIZE	DIMENSIONS						SPANNER	
	DN	inch				L		C <sub>A</sub>		D <sub>L</sub>		H <sub>F</sub>	H <sub>M</sub>
						inch	mm	inch	mm	inch	mm		
<b>T6916-2432</b>	38	1.1/2			-2432	10.39	264	6.97	177	5.43	138		

### SPECIAL FLANGE

### T6918

RYCO CODE 62K FLANGE  
80° TUBE BEND  
O RING NOT SUPPLIED

CLAMPS - SEE PAGES 274 & 282

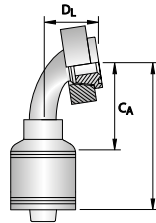

PART NO.	HOSE SIZE		THREAD SIZE	TUBE SIZE	DASH SIZE	DIMENSIONS						SPANNER	
	DN	inch				L		C <sub>A</sub>		D <sub>L</sub>		H <sub>F</sub>	H <sub>M</sub>
						inch	mm	inch	mm	inch	mm		
<b>T6918-3232</b>	51	2			-3232	11.69	297	7.56	192	6.30	160		

INTRODUCTION

INDEXES

ONE-PIECE COUPLINGS

PUSH-ON SUCTION & RETURN COUPLINGS

FIELD ATTACHABLE COUPLINGS

HYDRAULIC FITTINGS ACCESSORIES

# ONE-PIECE COUPLINGS

## T6000 SERIES ONE-PIECE CRIMP COUPLINGS

### SPECIAL FLANGE

### T6363

RYCO CODE 62C FLANGE  
67.5° TUBE BEND  
O RING NOT SUPPLIED

CLAMPS - SEE PAGES 274 & 282

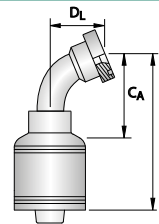

PART NO.	HOSE SIZE		THREAD SIZE	TUBE SIZE	DASH SIZE	DIMENSIONS						SPANNER	
	DN	inch				L		CA		DL		HF	HM
	DN	inch				inch	mm	inch	mm	inch	mm		
T6363-1212	19	3/4			-1212	5.00	127	2.95	75	2.05	52		
T6363-1216	19	3/4			-1216	5.04	128	2.99	76	2.09	53		
T6363-1616	25	1			-1616	6.18	157	3.58	91	2.09	53		
T6363-1620	25	1			-1620	6.22	158	3.62	92	2.20	56		
T6363-2020	31	1.1/4			-2020	7.24	184	4.57	116	2.64	67		
T6363-2024	31	1.1/4			-2024	6.93	176	4.25	108	2.99	76		
T6363-2424	38	1.1/2			-2424	8.66	220	5.20	132	3.03	77		

### SPECIAL FLANGE

### T6364

RYCO CODE 62C D-RING FLANGE  
67.5° TUBE BEND  
O RING NOT SUPPLIED

CLAMPS - SEE PAGES 274 & 282

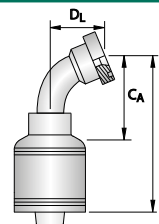

PART NO.	HOSE SIZE		THREAD SIZE	TUBE SIZE	DASH SIZE	DIMENSIONS						SPANNER	
	DN	inch				L		CA		DL		HF	HM
	DN	inch				inch	mm	inch	mm	inch	mm		
T6364-1212	19	3/4			-1212	5.00	127	2.95	75	2.05	52		
T6364-1216	19	3/4			-1216	5.16	131	3.11	79	2.09	53		
T6364-1616	25	1			-1616	6.18	157	3.58	91	2.09	53		
T6364-1620	25	1			-1620	6.22	158	3.62	92	2.20	56		
T6364-2020	31	1.1/4			-2020	7.13	181	4.45	113	2.64	67		
T6364-2024	31	1.1/4			-2024	6.93	176	4.25	108	2.99	76		

## T6000 SERIES ONE-PIECE CRIMP COUPLINGS

### SPECIAL FLANGE

### T6374

RYCO CODE 62C D-RING FLANGE  
67.5° TUBE BEND  
O RING NOT SUPPLIED

CLAMPS - SEE PAGES 274 & 282

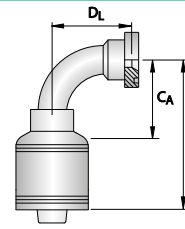

PART NO.	HOSE SIZE		THREAD SIZE	TUBE SIZE	DASH SIZE	DIMENSIONS						SPANNER	
	DN	inch				L		CA		DL		HF	HM
	DN	inch				inch	mm	inch	mm	inch	mm		
T6374-1212	19	3/4			-1212	4.29	109	2.24	57	2.44	62		
T6374-1216	19	3/4			-1216	4.29	109	2.24	57	2.60	66		
T6374-1616	25	1			-1616	5.28	134	2.68	68	2.83	72		
T6374-1620	25	1			-1620	5.39	137	2.80	71	2.95	75		
T6374-2020	31	1.1/4			-2020	6.02	153	3.35	85	3.27	83		
T6374-2024	31	1.1/4			-2024	6.18	157	3.50	89	3.35	85		

### SPECIAL FLANGE

### T6460

SAE CODE 62 FLANGE  
60° TUBE BEND  
O RING NOT SUPPLIED

CLAMPS - SEE PAGES 274 & 282

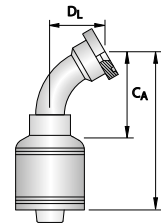

PART NO.	HOSE SIZE		THREAD SIZE	TUBE SIZE	DASH SIZE	DIMENSIONS						SPANNER	
	DN	inch				L		CA		DL		HF	HM
	DN	inch				inch	mm	inch	mm	inch	mm		
T6460-1212	19	3/4			-1212	5.28	134	3.23	82	1.42	36		
T6460-1216	19	3/4			-1216	5.28	134	3.23	82	1.50	38		
T6460-1616	25	1			-1616	6.46	164	3.86	98	1.73	44		
T6460-1620	25	1			-1620	6.50	165	3.90	99	1.81	46		
T6460-2020	31	1.1/4			-2020	6.69	170	4.02	102	1.97	50		
T6460-2024	31	1.1/4			-2024	7.60	193	4.92	125	2.28	58		
T6460-2424	38	1.1/2			-2424	9.61	244	6.14	156	2.80	71		
T6460-2432	38	1.1/2			-2432	9.76	248	6.30	160	3.11	79		
T6460-3232	51	2			-3232	12.83	326	8.70	221	3.98	101		

INTRODUCTION

INDEXES

ONE-PIECE COUPLINGS

PUSH-ON SUCTION & RETURN COUPLINGS

FIELD ATTACHABLE COUPLINGS

HYDRAULIC FITTINGS ACCESSORIES

# ONE-PIECE COUPLINGS

## T6000 SERIES ONE-PIECE CRIMP COUPLINGS

### SPECIAL FLANGE

### T6463

RYCO CODE 62C FLANGE  
60° TUBE BEND  
O RING NOT SUPPLIED

CLAMPS - SEE PAGES 274 & 282

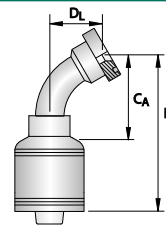

PART NO.	HOSE SIZE		THREAD SIZE	TUBE SIZE	DASH SIZE	DIMENSIONS						SPANNER	
	DN	inch				L		C <sub>A</sub>		D <sub>L</sub>		H <sub>F</sub>	H <sub>M</sub>
						inch	mm	inch	mm	inch	mm		
T6463-1212	19	3/4			-1212	5.28	134	3.23	82	1.81	46		
T6463-1216	19	3/4			-1216	5.51	140	3.46	88	1.65	42		
T6463-1616	25	1			-1616	6.50	165	3.90	99	1.85	47		
T6463-1620	25	1			-1620	6.69	170	4.09	104	1.93	49		
T6463-2020	31	1.1/4			-2020	7.52	191	4.84	123	2.20	56		
T6463-2024	31	1.1/4			-2024	7.20	183	4.53	115	2.60	66		
T6463-2424	38	1.1/2			-2424	9.17	233	5.71	145	2.68	68		

### SPECIAL FLANGE

### T6464

RYCO CODE 62C D-RING FLANGE  
60° TUBE BEND  
O RING NOT SUPPLIED

CLAMPS - SEE PAGES 274 & 282

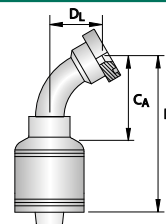

PART NO.	HOSE SIZE		THREAD SIZE	TUBE SIZE	DASH SIZE	DIMENSIONS						SPANNER	
	DN	inch				L		C <sub>A</sub>		D <sub>L</sub>		H <sub>F</sub>	H <sub>M</sub>
						inch	mm	inch	mm	inch	mm		
T6464-1212	19	3/4			-1212	5.35	136	3.31	84	1.65	42		
T6464-1216	19	3/4			-1216	5.35	136	3.31	84	1.65	42		
T6464-1616	25	1			-1616	6.42	163	3.82	97	1.85	47		
T6464-1620	25	1			-1620	6.57	167	3.98	101	1.93	49		
T6464-2020	31	1.1/4			-2020	7.48	190	4.80	122	2.20	56		
T6464-2024	31	1.1/4			-2024	8.43	214	5.75	146	2.60	66		

## T6000 SERIES ONE-PIECE CRIMP COUPLINGS

### SPECIAL FLANGE

### T6375

RYCO CODE 62K FLANGE  
90° TUBE BEND  
O RING NOT SUPPLIED

CLAMPS - SEE PAGES 274 & 282

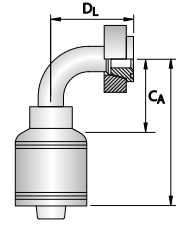

PART NO.	HOSE SIZE		THREAD SIZE	TUBE SIZE	DASH SIZE	DIMENSIONS						SPANNER	
	DN	inch				L		C <sub>A</sub>		D <sub>L</sub>		H <sub>F</sub>	H <sub>M</sub>
						inch	mm	inch	mm	inch	mm		
T6375-1616	25	1			-1616	6.02	153	3.43	87	3.54	90		
T6375-1620	25	1			-1620	6.02	153	3.43	87	3.94	100		
T6375-2016	31	1.1/4			-2016	6.42	163	3.74	95	3.54	90		
T6375-2020	31	1.1/4			-2020	7.83	199	5.16	131	4.72	120		
T6375-2024	31	1.1/4			-2024	7.83	199	5.16	131	4.72	120		
T6375-2420	38	1.1/2			-2420	8.76	223	5.31	135	5.12	130		
T6375-2424	38	1.1/2			-2424	8.86	225	5.43	138	5.51	140		
T6375-2432	38	1.1/2			-2432	8.86	225	5.43	138	6.30	160		
T6375-3224	51	2			-3224	10.42	265	6.30	160	6.89	175		
T6375-3232	51	2			-3232	10.94	278	6.81	173	7.09	180		

### SPECIAL FLANGE

### T6370

SAE CODE 62 FLANGE  
90° TUBE BEND  
O RING NOT SUPPLIED

CLAMPS - SEE PAGES 274 & 282

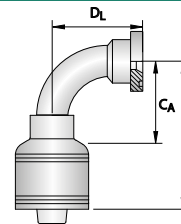

PART NO.	HOSE SIZE		THREAD SIZE	TUBE SIZE	DASH SIZE	DIMENSIONS						SPANNER	
	DN	inch				L		C <sub>A</sub>		D <sub>L</sub>		H <sub>F</sub>	H <sub>M</sub>
						inch	mm	inch	mm	inch	mm		
T6370-1212	19	3/4			-1212	4.29	109	2.24	57	2.20	56		
T6370-1216	19	3/4			-1216	4.29	109	2.24	57	2.40	61		
T6370-1612	25	1			-1612	4.96	126	2.36	60	2.20	56		
T6370-1616	25	1			-1616	5.28	134	2.68	68	2.76	70		
T6370-1620	25	1			-1620	5.35	136	2.76	70	2.80	71		
T6370-2016	31	1.1/4			-2016	5.79	147	3.11	79	2.76	70		
T6370-2020	31	1.1/4			-2020	6.14	156	3.46	88	3.15	80		
T6370-2024	31	1.1/4			-2024	6.18	157	3.50	89	3.39	86		
T6370-2424	38	1.1/2			-2424	7.36	187	3.90	99	3.86	98		
T6370-2432	38	1.1/2			-2432	7.56	192	4.09	104	4.09	104		
T6370-3232	51	2			-3232	10.63	270	6.50	165	5.16	131		

# ONE-PIECE COUPLINGS

## T6000 SERIES ONE-PIECE CRIMP COUPLINGS

### SPECIAL FLANGE

### T6373

RYCO CODE 62C FLANGE  
90° BEND  
O RING NOT SUPPLIED

CLAMPS - SEE PAGES 274 & 282

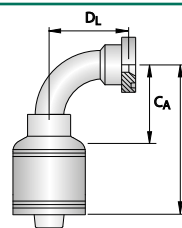

PART NO.	HOSE SIZE		THREAD SIZE	TUBE SIZE	DASH SIZE	DIMENSIONS						SPANNER	
	DN	inch				L		CA		DL		HF	HM
	DN	inch				inch	mm	inch	mm	inch	mm		
T6373-1212	19	3/4			-1212	4.33	110	2.28	58	2.44	62		
T6373-1216	19	3/4			-1216	4.33	110	2.28	58	2.56	65		
T6373-1616	25	1			-1616	5.28	134	2.68	68	2.91	74		
T6373-1620	25	1			-1620	5.28	134	2.68	68	2.95	75		
T6373-2020	31	1.1/4			-2020	6.10	155	3.43	87	3.27	83		
T6373-2024	31	1.1/4			-2024	6.18	157	3.50	89	3.35	85		
T6373-2424	38	1.1/2			-2424	7.68	195	4.21	107	3.94	100		
T6373-3232	51	2			-3232	9.72	247	5.59	142	5.24	133		

### SPECIAL FLANGE

### T6936

RYCO CODE 62K FLANGE  
100° TUBE BEND  
O RING NOT SUPPLIED

CLAMPS - SEE PAGES 274 & 282

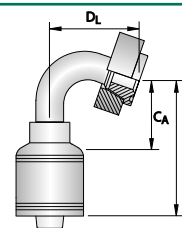

PART NO.	HOSE SIZE		THREAD SIZE	TUBE SIZE	DASH SIZE	DIMENSIONS						SPANNER	
	DN	inch				L		CA		DL		HF	HM
	DN	inch				inch	mm	inch	mm	inch	mm		
T6936-2020	31	1.1/4			-2020	7.40	188	4.72	120	4.92	125		
T6936-3232	51	2			-3232	9.84	250	5.71	145	7.87	200		

### SPECIAL FLANGE

### T6932

RYCO CODE 62K FLANGE  
105° TUBE BEND  
O RING NOT SUPPLIED

CLAMPS - SEE PAGES 274 & 282

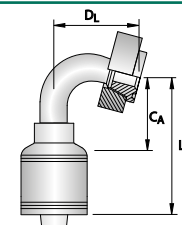

PART NO.	HOSE SIZE		THREAD SIZE	TUBE SIZE	DASH SIZE	DIMENSIONS						SPANNER	
	DN	inch				L		CA		DL		HF	HM
	DN	inch				inch	mm	inch	mm	inch	mm		
T6932-2424	38	1.1/2			-2424	7.32	186	3.90	99	6.18	157		

## T6000 SERIES ONE-PIECE CRIMP COUPLINGS

### SPECIAL FLANGE

### T6930

SAE CODE 62 FLANGE  
110° TUBE BEND  
O RING NOT SUPPLIED

CLAMPS - SEE PAGES 274 & 282

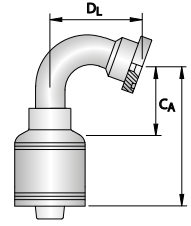

PART NO.	HOSE SIZE		THREAD SIZE	TUBE SIZE	DASH SIZE	DIMENSIONS						SPANNER	
	DN	inch				L		C <sub>A</sub>		D <sub>L</sub>		H <sub>F</sub>	H <sub>M</sub>
						inch	mm	inch	mm	inch	mm		
<b>T6930-2424</b>	38	1.1/2			-2424	9.02	229	5.59	142	4.69	119		
<b>T6930-2432</b>	38	1.1/2			-2432	9.09	231	5.63	143	4.80	122		
<b>T6930-3232</b>	51	2			-3232	10.28	261	6.14	156	6.02	153		

### SPECIAL FLANGE

### T6933

RYCO CODE 62C FLANGE  
110° TUBE BEND  
O RING NOT SUPPLIED

CLAMPS - SEE PAGES 274 & 282

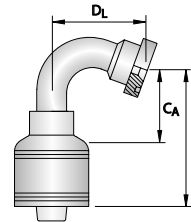

PART NO.	HOSE SIZE		THREAD SIZE	TUBE SIZE	DASH SIZE	DIMENSIONS						SPANNER	
	DN	inch				L		C <sub>A</sub>		D <sub>L</sub>		H <sub>F</sub>	H <sub>M</sub>
						inch	mm	inch	mm	inch	mm		
<b>T6933-2424</b>	38	1.1/2			-2424	9.02	229	5.55	141	4.72	120		
<b>T6933-3232</b>	51	2			-3232	9.84	250	5.71	145	5.35	136		

### HAMMER UNION

### T61502

FIGURE 1502  
HAMMER/WING MALE (WITH NUT)  
STANDARD SERVICE

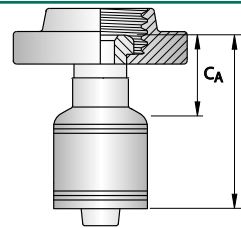

PART NO.	HOSE SIZE		THREAD SIZE	TUBE SIZE	DASH SIZE	DIMENSIONS						SPANNER	
	DN	inch				inch	L		C <sub>A</sub>		D <sub>L</sub>	H <sub>F</sub>	H <sub>M</sub>
						inch	mm	inch	mm				
<b>T61502-2432</b>	38	1.1/2	4.1/8		-2432	7.83	199	4.41	112				
<b>T61502-3232</b>	51	2	4.1/8		-3232	8.70	221	4.57	116				

INTRODUCTION

INDEXES

ONE-PIECE COUPLINGS

PUSH-ON SUCTION & RETURN COUPLINGS

FIELD ATTACHABLE COUPLINGS

HYDRAULIC FITTINGS ACCESSORIES

# ONE-PIECE COUPLINGS

## T6000 SERIES ONE-PIECE CRIMP COUPLINGS

**HAMMER UNION**

**T61501**

FIGURE 1502  
HAMMER/WING FEMALE (WITH SEAL)  
STANDARD SERVICE

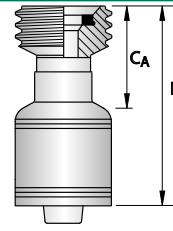

PART NO.	HOSE SIZE		THREAD SIZE	TUBE SIZE	DASH SIZE	DIMENSIONS				SPANNER					
	DN	inch	inch			L		C <sub>A</sub>		D <sub>L</sub>		H <sub>F</sub>		H <sub>M</sub>	
						inch	mm	inch	mm						
<b>T61501-2432</b>	38	1.1/2	4.1/8		-2432	7.09	180	3.66	93						
<b>T61501-3232</b>	51	2	4.1/8		-3232	7.95	202	3.82	97						

# T7000 SERIES ONE-PIECE CRIMP COUPLINGS

## HOSE COMPATIBILITY FOR T7000 SERIES

### NON-SKIVE

For Ryco Hose Series H3000D/S (sizes -20 to -32).  
 For Ryco Hose Series H4000D/S (sizes -06 to -32).  
 For Ryco Hose Series H5000D/S (sizes -06 to -24).  
 For Ryco Hose Series H6000D/S (sizes -06 to -20).  
 For Ryco Hose Series T2D/S/C (sizes -06 to -32).  
 For Ryco Hose Series E2, HSPD (sizes -06 to -16).  
 For Ryco Hose Series H12D/S (sizes -06 to -20).  
 For Ryco Hose Series R4SH, HSHD (sizes -20 to -32).  
 For Ryco Hose Series T2, TXA2D, SURVIVOR/2 (sizes -06 to -32).  
 For Ryco Hose Series D2B (sizes -24 to -32).  
 For Ryco Hose Series R4SP (cover must be skived) (all sizes).

### SKIVE

For Ryco Hose Series R4SPD (cover must be skived) all sizes.

## BSPT

## T7010

BSPT MALE  
60° SEAT

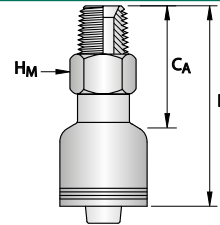

PART NO.	HOSE SIZE		THREAD SIZE	TUBE SIZE	DASH SIZE	DIMENSIONS				SPANNER			
	DN	inch	inch			L		CA		DL	HF	HM	
						inch	mm	inch	mm			inch	mm
T7010-0606	10	3/8	3/8" -19		-0606	2.44	62	1.30	33			11/16	
T7010-0808	12	1/2	1/2" -14		-0808	2.64	67	1.57	40			7/8	22
T7010-1212	19	3/4	3/4" -14		-1212	2.83	72	1.61	41			1.1/16	27
T7010-1616	25	1	1" -11		-1616	3.58	91	1.89	48			1.3/8	35
T7010-2020	31	1.1/4	1.1/4" -11		-2020	4.13	105	2.09	53			1.3/4	
T7010-2424	38	1.1/2	1.1/2" -11		-2424	4.37	111	2.17	55			2	50
T7010-3232	51	2	2" -11		-3232	5.08	129	2.60	66			2.1/2	

## BSPT

## T7014

BSPT MALE HEAVY  
60° SEAT

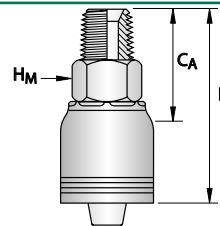

PART NO.	HOSE SIZE		THREAD SIZE	TUBE SIZE	DASH SIZE	DIMENSIONS				SPANNER			
	DN	inch	inch			L		CA		DL	HF	HM	
						inch	mm	inch	mm			inch	mm
T7014-1616	25	1	1" -11		-1616	3.57	91	1.88	48				36

# ONE-PIECE COUPLINGS

## T7000 SERIES ONE-PIECE CRIMP COUPLINGS

**BSPP**

**T7013**

BSPP MALE  
60° SEAT

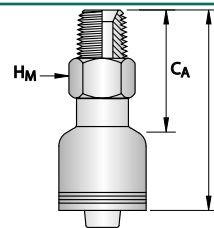

PART NO.	HOSE SIZE		THREAD SIZE	TUBE SIZE	DASH SIZE	DIMENSIONS				SPANNER					
	DN	inch	inch			L		C <sub>A</sub>		D <sub>L</sub>		H <sub>F</sub>		H <sub>M</sub>	
	DN	inch	inch			inch	mm	inch	mm			inch	mm	inch	mm
T7013-0606	10	3/8	3/8" -19		-0606	2.32	59	1.14	29					7/8	22
T7013-0808	12	1/2	1/2" -14		-0808	2.40	61	1.34	34					1.1/16	27
T7013-0810	12	1/2	5/8" -14		-0810	2.52	64	1.42	36					1.3/16	30
T7013-1212	19	3/4	3/4" -14		-1212	2.76	70	1.54	39					1.1/4	32
T7013-1216	19	3/4	3/4" -14		-1216	2.91	74	1.69	43					1.5/8	41
T7013-1616	25	1	1" -11		-1616	3.46	88	1.77	45					1.5/8	41
T7013-2020	31	1.1/4	1.1/4" -11		-2020	4.06	103	2.01	51					2	50
T7013-2424	38	1.1/2	1.1/2" -11		-2424	4.37	111	2.13	54					2.3/16	55
T7013-3232	51	2	2" -11		-3232	5.12	130	2.64	67					2.3/4	70

**BSPP**

**T7020**

BSPP FEMALE  
60° CONE

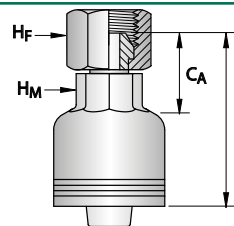

PART NO.	HOSE SIZE		THREAD SIZE	TUBE SIZE	DASH SIZE	DIMENSIONS				SPANNER					
	DN	inch	inch			L		C <sub>A</sub>		D <sub>L</sub>		H <sub>F</sub>		H <sub>M</sub>	
	DN	inch	inch			inch	mm	inch	mm			inch	mm	inch	mm
T7020-0606	10	3/8	3/8" -19		-0606	2.20	56	1.06	27			7/8	22	5/8	16
T7020-0808	12	1/2	1/2" -14		-0808	2.20	56	1.10	28			1.1/16	27	11/16	
T7020-1010	16	5/8	5/8" -14		-1010	2.40	61	1.14	29			1.3/16	30	7/8	22
T7020-1212	19	3/4	3/4" -14		-1212	2.52	62	1.30	31			1.1/4	32	1.1/16	27
T7020-1216	19	3/4	1" -11		-1216	2.76	68	1.54	37			1.1/2	38	1.1/16	27
T7020-1616	25	1	1" -11		-1616	3.15	80	1.46	36			1.1/2	38	1.1/4	32
T7020-2016	31	1.1/4	1" -11		-2016	3.74	95	1.73	44			1.1/2	38	1.5/8	41
T7020-2020	31	1.1/4	1.1/4" -11		-2020	3.78	96	1.77	45			2	50	1.5/8	41
T7020-2424	38	1.1/2	1.1/2" -11		-2424	3.98	101	1.77	45			2.3/16	55	2	50
T7020-3232	51	2	2" -11		-3232	4.61	117	2.13	54			2.3/4	70	2.1/2	

## T7000 SERIES ONE-PIECE CRIMP COUPLINGS

### BSPP

### T7022

BSPP FEMALE  
60° CONE  
HEAVY

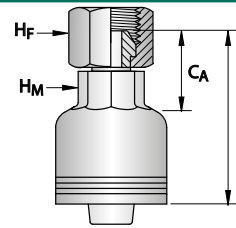

PART NO.	HOSE SIZE		THREAD SIZE	TUBE SIZE	DASH SIZE	DIMENSIONS						SPANNER			
	DN	inch	inch			L		C <sub>A</sub>		D <sub>L</sub>		H <sub>F</sub>		H <sub>M</sub>	
	DN	inch	inch			inch	mm	inch	mm	inch	mm	inch	mm	inch	mm
T7022-0808	12	1/2	1/2" -14		-0808	2.28	58	1.22	31			1		1	
T7022-1212	19	3/4	3/4" -14		-1212	2.56	65	1.34	34			1.1/4	32	1.1/8	
T7022-1616	25	1	1" -11		-1616	3.15	80	1.46	37			1.1/2	38	1.1/2	38
T7022-2020	31	1.1/4	1.1/4" -11		-2020	3.78	96	1.73	44			2	50	1.3/4	

### BSPP

### T7060

BSPP FEMALE  
60° CONE  
45° ELBOW

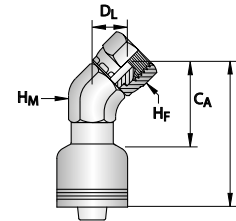

PART NO.	HOSE SIZE		THREAD SIZE	TUBE SIZE	DASH SIZE	DIMENSIONS						SPANNER			
	DN	inch	inch			L		C <sub>A</sub>		D <sub>L</sub>		H <sub>F</sub>		H <sub>M</sub>	
	DN	inch	inch			inch	mm	inch	mm	inch	mm	inch	mm	inch	mm
T7060-0808	12	1/2	1/2" -14		-0808	1.93	49	0.83	21	0.71	18	1.1/16	27	7/8	22
T7060-1212	19	3/4	3/4" -14		-1212	2.17	55	0.98	25	0.79	20	1.1/4	32	1.1/16	27
T7060-1616	25	1	1" -11		-1616	2.80	71	1.10	28	1.02	26	1.1/2	38	1.5/16	
T7060-2020	31	1.1/4	1.1/4" -11		-2020	3.15	80	1.10	28	1.14	29	2	50	1.7/8	

### BSPP

### T7050

BSPP FEMALE  
60° CONE  
90° ELBOW

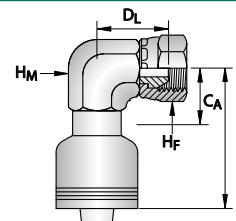

PART NO.	HOSE SIZE		THREAD SIZE	TUBE SIZE	DASH SIZE	DIMENSIONS						SPANNER			
	DN	inch	inch			L		C <sub>A</sub>		D <sub>L</sub>		H <sub>F</sub>		H <sub>M</sub>	
	DN	inch	inch			inch	mm	inch	mm	inch	mm	inch	mm	inch	mm
T7050-0606	10	3/8	3/8" -19		-0606	2.05	52	0.91	23	1.10	28	7/8	22	3/4	19
T7050-0808	12	1/2	1/2" -14		-0808	2.24	57	1.14	29	1.22	31	1.1/16	27	7/8	22
T7050-1212	19	3/4	3/4" -14		-1212	2.40	61	1.22	31	1.42	36	1.1/4	32	1.1/16	27
T7050-1616	25	1	1" -11		-1616	2.95	75	1.26	32	1.77	45	1.1/2	38	1.5/16	
T7050-2020	31	1.1/4	1.1/4" -11		-2020	3.74	95	1.69	43	2.05	52	2	50	1.7/8	
T7050-2424	38	1.1/2	1.1/2" -11		-2424	4.61	117	2.36	60	2.32	59	2.3/16	55	2.1/2	
T7050-3232	51	2	2" -11		-3232	4.69	119	2.20	56	2.44	62	2.3/4	70	2.1/2	

# ONE-PIECE COUPLINGS

## T7000 SERIES ONE-PIECE CRIMP COUPLINGS

**BSPP**

**T7270**

BSPP FEMALE  
60° CONE  
45° TUBE BEND

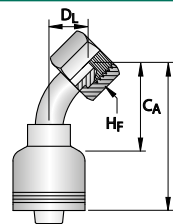

PART NO.	HOSE SIZE		THREAD SIZE	TUBE SIZE	DASH SIZE	DIMENSIONS						SPANNER		
	DN	inch	inch			L		C <sub>A</sub>		D <sub>L</sub>		H <sub>F</sub>		H <sub>M</sub>
	DN	inch	inch			inch	mm	inch	mm	inch	mm	inch	mm	
<b>T7270-0606</b>	10	3/8	3/8" -19		-0606	2.76	70	1.61	41	0.71	18	7/8	22	
<b>T7270-0808</b>	12	1/2	1/2" -14		-0808	3.07	78	1.97	50	0.87	22	1.1/16	27	
<b>T7270-1212</b>	19	3/4	3/4" -14		-1212	4.33	108	3.11	77	1.14	29	1.1/4	32	
<b>T7270-1616</b>	25	1	1" -11		-1616	5.04	128	3.35	83	1.65	42	1.1/2	38	32
<b>T7270-2020</b>	31	1.1/4	1.1/4" -11		-2020	8.50	216	6.50	165	1.81	46	2	50	
<b>T7270-2424</b>	38	1.1/2	1.1/2" -11		-2424	6.85	174	4.65	118	2.05	52	2.3/16	55	
<b>T7270-3232</b>	51	2	2" -11		-3232	8.39	213	5.91	150	2.56	65	2.3/4	70	

**BSPP**

**T7260**

BSPP FEMALE  
60° CONE  
90° TUBE BEND

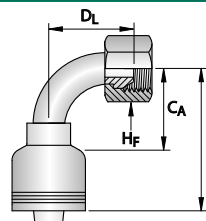

PART NO.	HOSE SIZE		THREAD SIZE	TUBE SIZE	DASH SIZE	DIMENSIONS						SPANNER		
	DN	inch	inch			L		C <sub>A</sub>		D <sub>L</sub>		H <sub>F</sub>		H <sub>M</sub>
	DN	inch	inch			inch	mm	inch	mm	inch	mm	inch	mm	
<b>T7260-0606</b>	10	3/8	3/8" -19		-0606	2.52	64	1.38	35	1.30	33	7/8	22	
<b>T7260-0808</b>	12	1/2	1/2" -14		-0808	2.56	65	1.50	38	1.77	45	1.1/16	27	
<b>T7260-1212</b>	19	3/4	3/4" -14		-1212	3.39	88	2.17	57	2.32	59	1.1/4	32	
<b>T7260-1616</b>	25	1	1" -11		-1616	4.37	111	2.68	74	3.07	78	1.1/2	38	
<b>T7260-2016</b>	31	1.1/4	1" -11		-2016	5.55	141	3.54	90	3.03	77	1.1/2	38	
<b>T7260-2020</b>	31	1.1/4	1.1/4" -11		-2020	5.28	134	3.23	82	3.58	91	2	50	
<b>T7260-2424</b>	38	1.1/2	1.1/2" -11		-2424	6.06	154	3.86	98	4.13	105	2.3/16	55	
<b>T7260-3232</b>	51	2	2" -11		-3232	7.87	200	5.39	137	5.20	132	2.3/4	70	

## T7000 SERIES ONE-PIECE CRIMP COUPLINGS

### BSPP

### T7210

BSPP FEMALE  
60° CONE  
90° LONG TUBE BEND

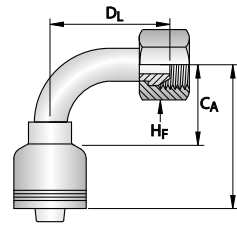

PART NO.	HOSE SIZE		THREAD SIZE	TUBE SIZE	DASH SIZE	DIMENSIONS						SPANNER			
	DN	inch	inch			L		C <sub>A</sub>		D <sub>L</sub>		H <sub>F</sub>		H <sub>M</sub>	
	DN	inch	inch			inch	mm	inch	mm	inch	mm	inch	mm	inch	mm
T7210-1212	19	3/4	3/4" -14		-1212	3.54	88	2.32	57	3.74	95	1.1/4	32		
T7210-1616	25	1	1" -11		-1616	4.25	108	2.56	74	4.57	116	1.1/2	38		
T7210-2020	31	1.1/4	1.1/4" -11		-2020	5.94	151	3.94	100	5.59	142				

### BSPO

### T7027

BSPP FEMALE O RING  
60° CONE

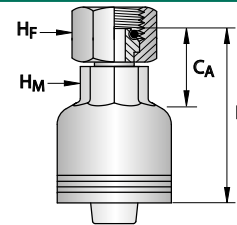

PART NO.	HOSE SIZE		THREAD SIZE	TUBE SIZE	DASH SIZE	DIMENSIONS						SPANNER			
	DN	inch	inch			L		C <sub>A</sub>		D <sub>L</sub>		H <sub>F</sub>		H <sub>M</sub>	
	DN	inch	inch			inch	mm	inch	mm			inch	mm	inch	mm
T7027-1212	19	3/4	3/4" -14		-1212	2.52	62	1.30	31			1.1/4	32	1.1/16	27
T7027-1616	25	1	1" -11		-1616	3.15	80	1.46	36			1.1/2	38	1.1/4	32

### BSPO

### T7057

BSPP FEMALE O RING  
60° CONE  
90° ELBOW

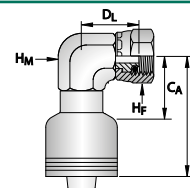

PART NO.	HOSE SIZE		THREAD SIZE	TUBE SIZE	DASH SIZE	DIMENSIONS						SPANNER			
	DN	inch	inch			L		C <sub>A</sub>		D <sub>L</sub>		H <sub>F</sub>		H <sub>M</sub>	
	DN	inch	inch			inch	mm	inch	mm	inch	mm	inch	mm	inch	mm
T7057-1212	19	3/4	3/4" -14		-1212	2.40	61	1.18	30	1.50	38	1.1/4	32	1.1/16	27

# ONE-PIECE COUPLINGS

## T7000 SERIES ONE-PIECE CRIMP COUPLINGS

**BSPO**

**T7277**

BSPP FEMALE O RING  
60° CONE  
45° TUBE BEND

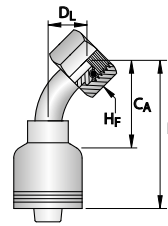

PART NO.	HOSE SIZE		THREAD SIZE	TUBE SIZE	DASH SIZE	DIMENSIONS						SPANNER			
	DN	inch	inch			L		C <sub>A</sub>		D <sub>L</sub>		H <sub>F</sub>		H <sub>M</sub>	
	DN	inch	inch			inch	mm	inch	mm	inch	mm	inch	mm		
<b>T7277-0808</b>	12	1/2	1/2" -14		-0808	3.07	78	1.97	50	0.87	22	1.1/16	27		
<b>T7277-1212</b>	19	3/4	3/4" -14		-1212	4.33	108	3.11	77	1.14	29	1.1/4	32		
<b>T7277-1616</b>	25	1	1" -11		-1616	5.00	127	3.31	83	1.38	35	1.1/2	38		

**BSPO**

**T7267**

BSPP FEMALE O RING  
60° CONE  
90° TUBE BEND

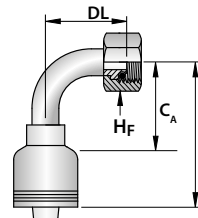

PART NO.	HOSE SIZE		THREAD SIZE	TUBE SIZE	DASH SIZE	DIMENSIONS						SPANNER			
	DN	inch	inch			L		C <sub>A</sub>		D <sub>L</sub>		H <sub>F</sub>		H <sub>M</sub>	
	DN	inch	inch			inch	mm	inch	mm	inch	mm	inch	mm		
<b>T7267-0808</b>	12	1/2	1/2" -14		-0808	2.72	69	1.61	41	1.73	44	1.1/16	27		
<b>T7267-1212</b>	19	3/4	3/4" -14		-1212	3.54	88	2.32	57	2.32	59	1.1/4	32		
<b>T7267-1616</b>	25	1	1" -11		-1616	4.57	116	2.87	74	2.95	75	1.1/2	38		

**NPTF**

**T7090**

NPTF MALE  
60° SEAT

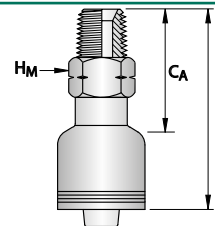

PART NO.	HOSE SIZE		THREAD SIZE	TUBE SIZE	DASH SIZE	DIMENSIONS						SPANNER			
	DN	inch	inch			L		C <sub>A</sub>		D <sub>L</sub>		H <sub>F</sub>		H <sub>M</sub>	
	DN	inch	inch			inch	mm	inch	mm					inch	mm
<b>T7090-0604</b>	10	3/8	1/4" -18		-0604	2.44	62	1.30	33					5/8	16
<b>T7090-0606</b>	10	3/8	3/8" -18		-0606	2.44	62	1.30	33					11/16	
<b>T7090-0806</b>	12	1/2	3/8" -18		-0806	2.44	62	1.38	35					11/16	
<b>T7090-0808</b>	12	1/2	1/2" -14		-0808	2.64	67	1.57	40					7/8	22
<b>T7090-1212</b>	19	3/4	3/4" -14		-1212	2.83	72	1.61	41					1.1/16	27
<b>T7090-1612</b>	25	1	3/4" -14		-1612	3.39	86	1.69	43					1.3/8	35
<b>T7090-1616</b>	25	1	1" -11,5		-1616	3.58	91	1.89	48					1.3/8	35
<b>T7090-2016</b>	31	1.1/4	1" -11,5		-2016	4.09	104	2.05	52					1.3/4	
<b>T7090-2020</b>	31	1.1/4	1.1/4" -11,5		-2020	4.13	105	2.09	53					1.3/4	
<b>T7090-2424</b>	38	1.1/2	1.1/2" -11,5		-2424	4.37	111	2.17	55					2	50
<b>T7090-3232</b>	51	2	2" -11,5		-3232	5.08	129	2.60	66					2.1/2	

## T7000 SERIES ONE-PIECE CRIMP COUPLINGS

### NPTF

### T7091

NPTF MALE EXTENDED  
60° SEAT

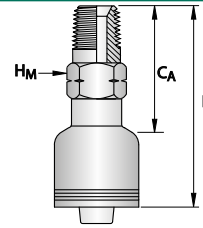

PART NO.	HOSE SIZE		THREAD SIZE	TUBE SIZE	DASH SIZE	DIMENSIONS				SPANNER			
	DN	inch	inch			L		C <sub>A</sub>		D <sub>L</sub>		H <sub>F</sub>	H <sub>M</sub>
						inch	mm	inch	mm			inch	
<b>T7091-3232</b>	51	2	2" -11,5		-3232	6.69	170	4.21	107				2.1/2

### NPSM

### T7020N

NPSM FEMALE  
60° CONE

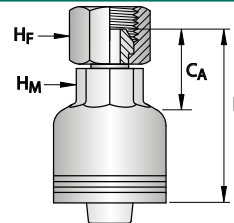

PART NO.	HOSE SIZE		THREAD SIZE	TUBE SIZE	DASH SIZE	DIMENSIONS				SPANNER			
	DN	inch	inch			L		C <sub>A</sub>		D <sub>L</sub>		H <sub>F</sub>	H <sub>M</sub>
						inch	mm	inch	mm			inch	mm
<b>T7020N-2020</b>	31	1.1/4	1.1/4" -11,5		-2020	3.66	93	1.61	41			1.7/8	1.3/4
<b>T7020N-2424</b>	38	1.1/2	1.1/2" -11,5		-2424	4.02	102	1.77	45			2.1/4	57
<b>T7020N-3232</b>	51	2	2" -11,5		-3232	4.61	117	2.13	54			2.3/4	70

### JIC

### T7030

JIC 37°  
CONE MALE

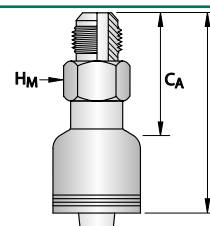

PART NO.	HOSE SIZE		THREAD SIZE	TUBE SIZE	DASH SIZE	DIMENSIONS				SPANNER			
	DN	inch	inch			L		C <sub>A</sub>		D <sub>L</sub>		H <sub>F</sub>	H <sub>M</sub>
						inch	mm	inch	mm			inch	mm
<b>T7030-0609</b>	10	3/8	9/16" -18		-0609	2.40	61	1.26	32				5/8
<b>T7030-0812</b>	12	1/2	3/4" -16		-0812	2.52	64	1.46	37				3/4
<b>T7030-0814</b>	12	1/2	7/8" -14		-0814	2.64	67	1.54	39				15/16
<b>T7030-1014</b>	16	5/8	7/8" -14		-1014	2.87	73	1.57	40				15/16
<b>T7030-1217</b>	19	3/4	1.1/16" -12		-1217	2.95	75	1.73	44				1.1/8
<b>T7030-1219</b>	19	3/4	1.3/16" -12		-1219	2.95	75	1.77	45				1.1/4
<b>T7030-1221</b>	19	3/4	1.5/16" -12		-1221	2.99	76	1.77	45				1.3/8
<b>T7030-1621</b>	25	1	1.5/16" -12		-1621	3.54	90	1.85	47				1.3/8
<b>T7030-2026</b>	31	1.1/4	1.5/8" -12		-2026	4.09	104	2.05	52				1.3/4
<b>T7030-2430</b>	38	1.1/2	1.7/8" -12		-2430	4.45	113	2.24	57				2
<b>T7030-3240</b>	51	2	2.1/2" -12		-3240	5.35	136	2.87	73				2.1/2

# ONE-PIECE COUPLINGS

## T7000 SERIES ONE-PIECE CRIMP COUPLINGS

JIC

T7031

JIC 37° CONE MALE  
METRIC HEX ONLY

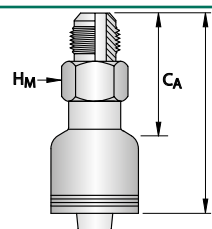

PART NO.	HOSE SIZE		THREAD SIZE	TUBE SIZE	DASH SIZE	DIMENSIONS					SPANNER			
	DN	inch	inch			L		C <sub>A</sub>		D <sub>L</sub>		H <sub>F</sub>		H <sub>M</sub>
						inch	mm	inch	mm			inch	mm	mm
T7031-1221	19	3/4	1.5/16" -12		-1221	2.99	76	1.77	45					36
T7031-1621	25	1	1.5/16" -12		-1621	3.54	90	1.85	47					36

JSEAL™ / JIC

T7040

JSEAL™ / JIC FEMALE  
CONVEX SEAT

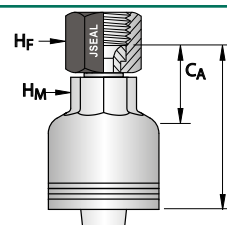

PART NO.	HOSE SIZE		THREAD SIZE	TUBE SIZE	DASH SIZE	DIMENSIONS					SPANNER				
	DN	inch	inch			L		C <sub>A</sub>		D <sub>L</sub>		H <sub>F</sub>		H <sub>M</sub>	
						inch	mm	inch	mm			inch	mm	mm	
T7040-0609	10	3/8	9/16" -18		-0609	2.01	51	0.87	22			11/16		9/16	16
T7040-0609	10	3/8	9/16" -18		-0609	2.01	51	0.87	22			3/4	19	9/16	
T7040-0612	10	3/8	3/4" -16		-0612	2.17	54	1.02	25			7/8	22	9/16	16
T7040-0812	12	1/2	3/4" -16		-0812	2.01	53	0.94	25			7/8	22	11/16	19
T7040-0814	12	1/2	7/8" -14		-0814	2.17	55	1.06	27			1		11/16	
T7040-0817	12	1/2	1.1/16" -12		-0817	2.32	59	1.22	31			1.1/4	32	11/16	
T7040-1012	16	5/8	3/4" -16		-1012	2.28	58	0.98	25			7/8	22	7/8	22
T7040-1014	16	5/8	7/8" -14		-1014	2.32	59	1.06	27			1		7/8	22
T7040-1017	16	5/8	1.1/16" -12		-1017	2.48	63	1.18	30			1.1/4	32	7/8	22
T7040-1212	19	3/4	3/4" -16		-1212	2.40	59	1.18	28			7/8	22	1.1/16	27
T7040-1214	19	3/4	7/8" -14		-1214	2.56	63	1.34	32			1		1.1/16	27
T7040-1217	19	3/4	1.1/16" -12		-1217	2.44	60	1.22	29			1.1/4	32	1.1/16	27
T7040-1219	19	3/4	1.3/16" -12		-1219	2.44	62	1.22	31			1.3/8	35	1.1/8	
T7040-1221	19	3/4	1.5/16" -12		-1221	2.72	67	1.50	36			1.1/2	38	1.1/16	27
T7040-1617	25	1	1.1/16" -12		-1617	3.03	77	1.34	37			1.1/4	32	1.1/4	32
T7040-1621	25	1	1.5/16" -12		-1621	3.07	78	1.38	33			1.1/2	38	1.1/4	32
T7040-1626	25	1	1.5/8" -12		-1626	3.31	84	1.61	38			2	50	1.1/4	32
T7040-2021	31	1.1/4	1.5/16" -12		-2021	3.70	94	1.69	43			1.1/2	38	1.5/8	41
T7040-2026	31	1.1/4	1.5/8" -12		-2026	3.70	94	1.69	43			2	50	1.5/8	41
T7040-2030	31	1.1/4	1.7/8" -12		-2030	4.06	103	2.05	52			2.1/4	57	1.5/8	41
T7040-2430	38	1.1/2	1.7/8" -12		-2430	4.29	109	2.09	53			2.1/4	57	2	50
T7040-3240	51	2	2.1/2" -12		-3240	4.88	124	2.44	62			2.7/8	73	2.1/2	

## T7000 SERIES ONE-PIECE CRIMP COUPLINGS

### JSEAL™ / JIC

### T7041

JSEAL™ / JIC FEMALE  
CONVEX SEAT  
METRIC NUT ONLY

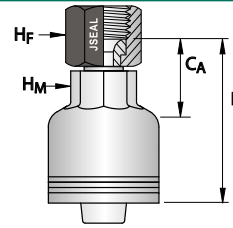

PART NO.	HOSE SIZE		THREAD SIZE	TUBE SIZE	DASH SIZE	DIMENSIONS						SPANNER			
	DN	inch	inch			L		C <sub>A</sub>		D <sub>L</sub>		H <sub>F</sub>		H <sub>M</sub>	
						inch	mm	inch	mm	inch	mm	inch	mm		mm
<b>T7041-0609</b>	10	3/8	9/16" -18		-0609	2.52	64	1.34	34	1.02	26	3/4	19		16

### JIC

### T7039

JIC  
37° CONE  
MALE SWIVEL JOINT

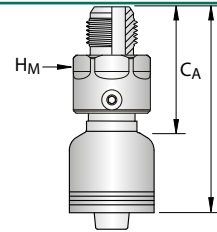

PART NO.	HOSE SIZE		THREAD SIZE	TUBE SIZE	DASH SIZE	DIMENSIONS						SPANNER			
	DN	inch	inch			L		C <sub>A</sub>		D <sub>L</sub>		H <sub>F</sub>		H <sub>M</sub>	
						inch	mm	inch	mm			inch	mm		
<b>T7039-0609</b>	10	3/8	9/16" -18		-0609	3.23	82	2.09	53			1	0		
<b>T7039-0812</b>	12	1/2	3/4" -16		-0812	3.39	86	2.32	59				36		
<b>T7039-1217</b>	19	3/4	1.1/16" -12		-1217	3.74	95	2.56	65			1.1/2	38		
<b>T7039-1621</b>	25	1	1.5/16" -12		-1621	4.92	125	3.23	82				46		

### JIC - HEAVY DUTY

### T7045

JIC  
37° FEMALE HIGH-PRESSURE

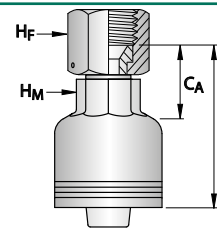

PART NO.	HOSE SIZE		THREAD SIZE	TUBE SIZE	DASH SIZE	DIMENSIONS						SPANNER			
	DN	inch	inch			L		C <sub>A</sub>		D <sub>L</sub>		H <sub>F</sub>		H <sub>M</sub>	
						inch	mm	inch	mm			inch	mm	inch	mm
<b>T7045-1621</b>	25	1	1.5/16" -12		-1621	2.99	76	1.30	33			1.5/8	41	1.1/4	32
<b>T7045-2026</b>	31	1.1/4	1.5/8" -12		-2026	3.62	92	1.57	40			2	50	1.3/4	
<b>T7045-2430</b>	38	1.1/2	1.7/8" -12		-2430	4.45	113	2.20	56			2.1/4	57	2	50

# ONE-PIECE COUPLINGS

## T7000 SERIES ONE-PIECE CRIMP COUPLINGS

JSEAL™ / JIC

T7080

JSEAL™ / JIC FEMALE  
CONVEX SEAT  
45° ELBOW

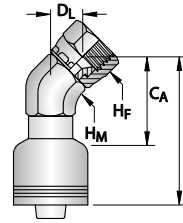

PART NO.	HOSE SIZE		THREAD SIZE	TUBE SIZE	DASH SIZE	DIMENSIONS						SPANNER			
	DN	inch	inch			L		CA		DL		HF		HM	
	DN	inch	inch			inch	mm	inch	mm	inch	mm	inch	mm	inch	mm
T7080-0812	12	1/2	3/4" -16		-0812	1.93	49	0.83	21	0.63	16	7/8	22	7/8	22
T7080-0814	12	1/2	7/8" -14		-0814	2.56	65	1.50	38	0.67	17	1		7/8	22
T7080-1217	19	3/4	1.1/16" -12		-1217	2.17	55	0.98	25	0.67	17	1.1/4	32	1.1/16	27
T7080-1621	25	1	1.5/16" -12		-1621	2.80	71	1.10	28	0.83	21	1.1/2	38	1.5/16	

JSEAL™ / JIC

T7070

JSEAL™ / JIC FEMALE  
CONVEX SEAT  
90° ELBOW

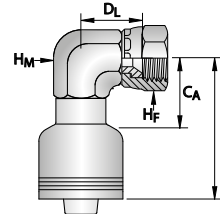

PART NO.	HOSE SIZE		THREAD SIZE	TUBE SIZE	DASH SIZE	DIMENSIONS						SPANNER			
	DN	inch	inch			L		CA		DL		HF		HM	
	DN	inch	inch			inch	mm	inch	mm	inch	mm	inch	mm	inch	mm
T7070-0814	12	1/2	7/8" -14		-0814	2.24	57	1.14	29	1.22	31	1		7/8	22
T7070-1217	19	3/4	1.1/16" -12		-1217	2.40	61	1.22	31	1.26	32	1.1/4	32	1.1/16	27
T7070-1621	25	1	1.5/16" -12		-1621	2.95	75	1.26	32	1.50	38	1.1/2	38	1.5/16	

METRIC - DKOL

T7250

JSEAL™ / JIC FEMALE  
CONVEX SEAT  
45° TUBE BEND

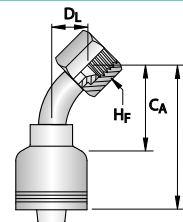

PART NO.	HOSE SIZE		THREAD SIZE	TUBE SIZE	DASH SIZE	DIMENSIONS						SPANNER			
	DN	inch	inch			L		CA		DL		HF		HM	
	DN	inch	inch			inch	mm	inch	mm	inch	mm	inch	mm		
T7250-1017	16	5/8	1.1/16" -12		-1017	3.43	87	2.13	54	0.94	24	1.1/4	32		
T7250-1217	19	3/4	1.1/16" -12		-1217	4.33	108	3.11	77	1.10	28	1.1/4	32		
T7250-1221	19	3/4	1.5/16" -12		-1221	4.72	118	3.50	87	1.50	38	1.1/2	38		
T7250-1621	25	1	1.5/16" -12		-1621	5.00	127	3.31	82	1.38	35	1.1/2	38		
T7250-2026	31	1.1/4	1.5/8" -12		-2026	5.94	151	3.94	100	1.54	39	2	50		
T7250-2430	38	1.1/2	1.7/8" -12		-2430	7.24	184	5.04	128	1.97	50	2.1/4	57		
T7250-3240	51	2	2.1/2" -12		-3240	8.94	227	6.46	164	2.48	63	2.7/8	73		

## T7000 SERIES ONE-PIECE CRIMP COUPLINGS

### JSEAL™ / JIC

### T7251

JSEAL™ / JIC  
FEMALE CONVEX SEAT  
45° TUBE BEND  
METRIC NUT ONLY

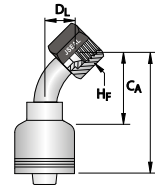

PART NO.	HOSE SIZE		THREAD SIZE	TUBE SIZE	DASH SIZE	DIMENSIONS						SPANNER		
	DN	inch	inch			L		C <sub>A</sub>		D <sub>L</sub>		H <sub>F</sub>		H <sub>M</sub>
T7251-0609	10	3/8	9/16" -18		-0609	2.68	68	1.50	38	0.55	14	3/4	19	

### JIC

### T7243

JSEAL™ / JIC FEMALE  
CONVEX SEAT  
90° SHORT TUBE BEND

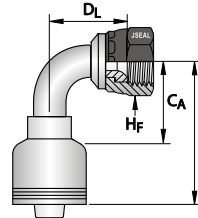

PART NO.	HOSE SIZE		THREAD SIZE	TUBE SIZE	DASH SIZE	DIMENSIONS						SPANNER		
	DN	inch	inch			L		C <sub>A</sub>		D <sub>L</sub>		H <sub>F</sub>		H <sub>M</sub>
T7243-0609	10	3/8	9/16" -18		-0609	2.40	61	1.22	31	0.91	23	11/16		
T7243-0812	12	1/2	3/4" -16		-0812	2.80	71	1.69	43	1.14	29	7/8	22	
T7243-1014	16	5/8	7/8" -14		-1014	3.39	86	2.09	53	1.34	34	1		
T7243-1217	19	3/4	1.1/16" -12		-1217	3.82	95	2.60	64	1.85	47	1.1/4	32	
T7243-1621	25	1	1.5/16" -12		-1621	4.88	124	3.19	79	2.28	58	1.1/2	38	

### JSEAL™ / JIC

### T7244

JSEAL™ / JIC FEMALE  
CONVEX SEAT  
90° SHORT TUBE BEND  
METRIC NUT ONLY

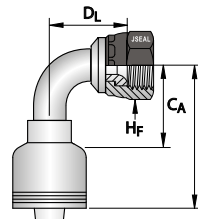

PART NO.	HOSE SIZE		THREAD SIZE	TUBE SIZE	DASH SIZE	DIMENSIONS						SPANNER		
	DN	inch	inch			L		C <sub>A</sub>		D <sub>L</sub>		H <sub>F</sub>		H <sub>M</sub>
T7244-0609	10	3/8	9/16" -18		-0609	2.40	61	1.22	31	0.91	23	3/4	19	

INTRODUCTION

INDEXES

ONE-PIECE  
COUPLINGS

PUSH-ON SUCTION &  
RETURN COUPLINGS

FIELD ATTACHABLE  
COUPLINGS

HYDRAULIC FITTINGS  
ACCESSORIES

# ONE-PIECE COUPLINGS

## T7000 SERIES ONE-PIECE CRIMP COUPLINGS

JIC

T7240

JSEAL™ / JIC FEMALE  
CONVEX SEAT  
90° TUBE BEND

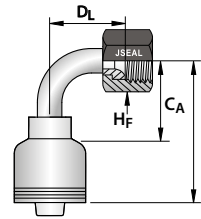

PART NO.	HOSE SIZE		THREAD SIZE	TUBE SIZE	DASH SIZE	DIMENSIONS						SPANNER		
	DN	inch	inch			L		C <sub>A</sub>		D <sub>L</sub>		H <sub>F</sub>		H <sub>M</sub>
	DN	inch	inch			inch	mm	inch	mm	inch	mm	inch	mm	
T7240-0609	10	3/8	9/16" -18		-0609	2.52	64	1.34	34	1.02	26	11/16		
T7240-0612	10	3/8	3/4" -16		-0612	2.56	65	1.38	35	1.18	30	7/8	22	
T7240-0812	12	1/2	3/4" -16		-0812	2.72	69	1.61	41	1.50	38	7/8	22	
T7240-0814	12	1/2	7/8" -14		-0814	2.72	69	1.61	41	1.61	41	1		
T7240-1014	16	5/8	7/8" -14		-1014	3.07	78	1.77	45	1.85	47	1		
T7240-1017	16	5/8	1.1/16" -12		-1017	3.07	78	1.77	45	1.89	48	1.1/4	32	
T7240-1217	19	3/4	1.1/16" -12		-1217	3.54	88	2.32	57	2.24	57	1.1/4	32	
T7240-1221	19	3/4	1.5/16" -12		-1221	3.54	88	2.32	57	2.80	71	1.1/2	38	
T7240-1621	25	1	1.5/16" -12		-1621	4.37	111	2.68	74	2.83	72	1.1/2	38	
T7240-2026	31	1.1/4	1.5/8" -12		-2026	5.94	151	3.94	100	3.19	81	2	50	
T7240-2430	38	1.1/2	1.7/8" -12		-2430	6.38	162	4.17	106	4.17	106	2.1/4	57	
T7240-3240	51	2	2.1/2" -12		-3240	8.31	211	5.83	148	5.20	132	2.7/8	73	

JSEAL™ / JIC

T7241

JSEAL™ / JIC FEMALE  
CONVEX SEAT  
90° TUBE BEND  
METRIC NUT ONLY

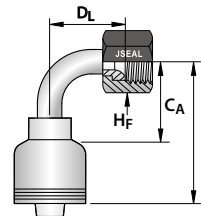

PART NO.	HOSE SIZE		THREAD SIZE	TUBE SIZE	DASH SIZE	DIMENSIONS						SPANNER		
	DN	inch	inch			L		C <sub>A</sub>		D <sub>L</sub>		H <sub>F</sub>		H <sub>M</sub>
	DN	inch	inch			inch	mm	inch	mm	inch	mm	inch	mm	
T7241-0609	10	3/8	9/16" -18		-0609	2.52	64	1.34	34	1.02	26	3/4	19	

## T7000 SERIES ONE-PIECE CRIMP COUPLINGS

### JSEAL™ / JIC

### T7245

JIC 37° FEMALE  
HIGH-PRESSURE  
90° TUBE BEND

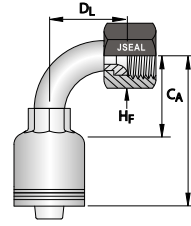

PART NO.	HOSE SIZE		THREAD SIZE	TUBE SIZE	DASH SIZE	DIMENSIONS						SPANNER		
	DN	inch	inch			L		C <sub>A</sub>		D <sub>L</sub>		H <sub>F</sub>		H <sub>M</sub>
						inch	mm	inch	mm	inch	mm	inch	mm	
<b>T7245-1621</b>	25	1	1.5/16" -12		-1621	4.53	115	2.83	72	2.83	72	1 5/8		
<b>T7245-2026</b>	31	1.1/4	1.5/8" -12		-2026	5.51	140	3.46	88	3.07	78	2	50	
<b>T7245-2430</b>	38	1.1/2	1.7/8" -12		-2430	6.26	159	4.06	103	4.17	106	2.1/4	57	

### JIC

### T7280

JSEAL™ / JIC FEMALE  
CONVEX SEAT  
90° LONG TUBE BEND

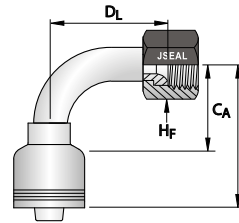

PART NO.	HOSE SIZE		THREAD SIZE	TUBE SIZE	DASH SIZE	DIMENSIONS						SPANNER		
	DN	inch	inch			L		C <sub>A</sub>		D <sub>L</sub>		H <sub>F</sub>		H <sub>M</sub>
						inch	mm	inch	mm	inch	mm	inch	mm	
<b>T7280-1217</b>	19	3/4	1.1/16" -12		-1217	3.54	88	2.32	57	3.78	96	1.1/4	32	
<b>T7280-1621</b>	25	1	1.5/16" -12		-1621	4.65	118	2.95	74	4.49	114	1.1/2	38	
<b>T7280-2026</b>	31	1.1/4	1.5/8" -12		-2026	5.94	151	3.94	100	5.08	129	2	50	

### JIC

### T7044

JIC  
37° FEMALE SWIVEL JOINT

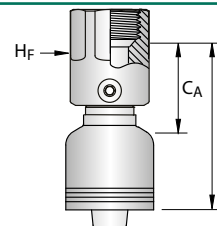

PART NO.	HOSE SIZE		THREAD SIZE	TUBE SIZE	DASH SIZE	DIMENSIONS						SPANNER		
	DN	inch	inch			L		C <sub>A</sub>		D <sub>L</sub>	H <sub>F</sub>		H <sub>M</sub>	
						inch	mm	inch	mm		inch	mm		
<b>T7044-0609</b>	10	3/8	9/16" -18		-0609	2.80	71	1.65	42			1	25	
<b>T7044-0812</b>	12	1/2	3/4" -16		-0812	2.83	72	1.77	45				36	
<b>T7044-1217</b>	19	3/4	1.1/16" -12		-1217	3.03	77	1.81	46			1.1/2	38	
<b>T7044-1621</b>	25	1	1.5/16" -12		-1621	4.17	106	2.48	63				46	

# ONE-PIECE COUPLINGS

## T7000 SERIES ONE-PIECE CRIMP COUPLINGS

### JIS - BSP

### T7122

METRIC FEMALE  
60° CONCAVE SEAT (JIS)

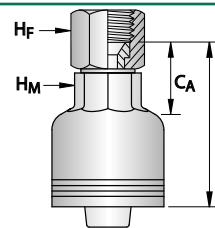

PART NO.	HOSE SIZE		THREAD SIZE	TUBE SIZE	DASH SIZE	DIMENSIONS				SPANNER					
	DN	inch	inch			L		C <sub>A</sub>		D <sub>L</sub>		H <sub>F</sub>		H <sub>M</sub>	
						inch	mm	inch	mm			inch	mm	inch	mm
<b>T7122-0808</b>	12	1/2	1/2" -14		-0808	2.17	55	1.06	27			1.1/16	27	3/4	19
<b>T7122-1012</b>	16	5/8	3/4" -14		-1012	2.36	60	1.10	28				36	1.1/16	27
<b>T7122-1212</b>	19	3/4	3/4" -14		-1212	2.40	61	1.18	30				36	1.1/16	27
<b>T7122-1616</b>	25	1	1" -11		-1616	2.95	75	1.26	32			1.5/8	41		36

### JIS - METRIC

### T7680

METRIC FEMALE  
60° CONCAVE SEAT (JIS)

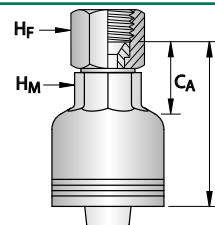

PART NO.	HOSE SIZE		THREAD SIZE	TUBE SIZE	DASH SIZE	DIMENSIONS				SPANNER					
	DN	inch	mm			L		C <sub>A</sub>		D <sub>L</sub>		H <sub>F</sub>		H <sub>M</sub>	
						inch	mm	inch	mm			inch	mm	inch	mm
<b>T7680-0618</b>	10	3/8	M 18X1,5		-0618	2.01	51	0.87	22			15/16	24		17
<b>T7680-0822</b>	12	1/2	M 22X1,5		-0822	2.17	55	1.10	28			1.1/16	27	7/8	22
<b>T7680-0824</b>	12	1/2	M 24X1,5		-0824	2.17	55	1.10	28			1.1/4	32	7/8	22
<b>T7680-1024</b>	16	5/8	M 24X1,5		-1024	2.28	58	1.02	26			1.1/4	32	7/8	22
<b>T7680-1224</b>	19	3/4	M 24X1,5		-1224	2.28	58	1.06	27			1.1/4	32	1.1/16	27
<b>T7680-1230</b>	19	3/4	M 30X1,5		-1230	2.56	65	1.34	34				36	1.1/4	32
<b>T7680-1633</b>	25	1	M 33X1,5		-1633	2.87	73	1.18	30			1.5/8	41	1.1/4	32
<b>T7680-1636</b>	25	1	M 36X1,5		-1636	3.15	80	1.46	37				46	1.1/2	38
<b>T7680-2036</b>	31	1.1/4	M 36X1,5		-2036	3.50	89	1.46	37				46	1.1/2	38
<b>T7680-2042</b>	31	1.1/4	M 42X1,5		-2042	3.58	91	1.54	39			2	50	1.5/8	41
<b>T7680-2442</b>	38	1.1/2	M 42X1,5		-2442	3.82	97	1.61	41			2	50		46

## T7000 SERIES ONE-PIECE CRIMP COUPLINGS

### JOINER

### T7900

JOINER

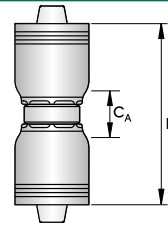

PART NO.	HOSE SIZE		THREAD SIZE	TUBE SIZE	DASH SIZE	DIMENSIONS				SPANNER					
	DN	inch		inch		L		C <sub>A</sub>		D <sub>L</sub>		H <sub>F</sub>		H <sub>M</sub>	
<b>T7900-0606</b>	10	3/8		3/8	-0606	2.87	73	0.59	15						
<b>T7900-0808</b>	12	1/2		1/2	-0808	2.76	70	0.59	15						
<b>T7900-1212</b>	19	3/4		3/4	-1212	3.07	78	0.63	16						
<b>T7900-1616</b>	25	1		1	-1616	4.37	111	0.98	25						
<b>T7900-2020</b>	31	1.1/4		1.1/4	-2020	5.04	128	0.94	24						
<b>T7900-2424</b>	38	1.1/2		1.1/2	-2424	5.43	138	1.02	26						
<b>T7900-3232</b>	51	2		2	-3232	5.98	152	1.06	27						

### METRIC - DKOL

### T7501

DKOL FEMALE  
24° CONE

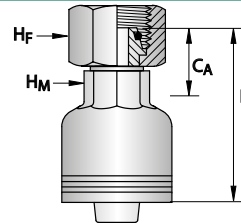

PART NO.	HOSE SIZE		THREAD SIZE	TUBE SIZE	DASH SIZE	DIMENSIONS				SPANNER					
	DN	inch	mm	mm		L		C <sub>A</sub>		D <sub>L</sub>		H <sub>F</sub>		H <sub>M</sub>	
<b>T7501-1230</b>	19	3/4	M 30X2	22	-1230	2.72	67	1.50	36			inch	mm	inch	mm
<b>T7501-1636</b>	25	1	M 36X2	28	-1636	3.39	86	1.69	39			1.5/8	41	1.1/4	32
<b>T7501-2045</b>	31	1.1/4	M 45X2	35	-2045	3.86	98	1.85	47			2	50	1.5/8	41
<b>T7501-2452</b>	38	1.1/2	M 52X2	42	-2452	3.58	91	1.38	35			2.3/8	60		

### METRIC - DKOL

### T7510

DKOL FEMALE  
24° CONE  
45° TUBE BEND

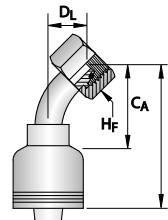

PART NO.	HOSE SIZE		THREAD SIZE	TUBE SIZE	DASH SIZE	DIMENSIONS				SPANNER					
	DN	inch	mm	mm		L		C <sub>A</sub>		D <sub>L</sub>		H <sub>F</sub>		H <sub>M</sub>	
<b>T7510-2452</b>	38	1.1/2	M 52X2	42	-2452	6.85	174	4.65	118	1.93	49	2.3/8	60		

# ONE-PIECE COUPLINGS

## T7000 SERIES ONE-PIECE CRIMP COUPLINGS

### METRIC DKOL

### T7520

DKOL FEMALE  
24° CONE  
90° TUBE BEND

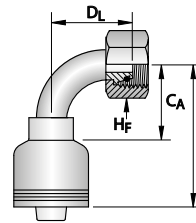

PART NO.	HOSE SIZE		THREAD SIZE	TUBE SIZE	DASH SIZE	DIMENSIONS						SPANNER			
	DN	inch	mm	mm		L		CA		DL		HF		HM	
						inch	mm	inch	mm	inch	mm	inch	mm		
<b>T7520-2452</b>	38	1.1/2	M 52X2	42	-2452	6.10	155	3.90	99	4.02	102	2.3/8	60		

### METRIC - DKS

### T7630

DKS MALE  
24° SEAT

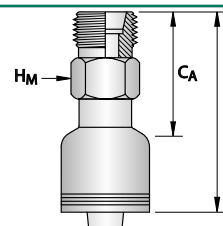

PART NO.	HOSE SIZE		THREAD SIZE	TUBE SIZE	DASH SIZE	DIMENSIONS						SPANNER			
	DN	inch	mm	mm		L		CA		DL		HF		HM	
						inch	mm	inch	mm			inch	mm		
<b>T7630-2042</b>	31	1.1/4	M 42X2	30	-2042	3.94	100	1.89	48						46
<b>T7630-2052</b>	31	1.1/4	M 52X2	38	-2052	3.90	99	1.85	47					2.3/16	55

### METRIC - DKOS

### T7711

DKOS FEMALE  
24° CONE

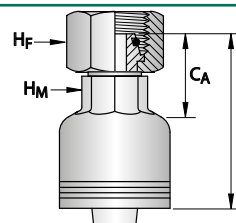

PART NO.	HOSE SIZE		THREAD SIZE	TUBE SIZE	DASH SIZE	DIMENSIONS						SPANNER			
	DN	inch	mm	mm		L		CA		DL		HF		HM	
						inch	mm	inch	mm			inch	mm	inch	mm
<b>T7711-0618</b>	10	3/8	M 18X1,5	10	-0618	2.36	60	1.22	31			7/8	22	9/16	
<b>T7711-0620</b>	10	3/8	M 20X1,5	12	-0620	2.40	61	1.22	31			15/16	24	9/16	
<b>T7711-0622</b>	10	3/8	M 22X1,5	14	-0622	2.48	63	1.30	33			1.1/16	27	9/16	
<b>T7711-0824</b>	12	1/2	M 24X1,5	16	-0824	2.40	61	1.30	33			1.3/16	30	11/16	
<b>T7711-1030</b>	16	5/8	M 30X2	20	-1030	2.83	72	1.57	40				36	7/8	22
<b>T7711-1036</b>	16	5/8	M 36X2	25	-1036	2.99	76	1.73	44				46	7/8	22
<b>T7711-1230</b>	19	3/4	M 30X2	20	-1230	2.87	71	1.65	40				36	1.1/16	27
<b>T7711-1236</b>	19	3/4	M 36X2	25	-1236	3.03	75	1.81	44				46	1.1/16	27
<b>T7711-1242</b>	19	3/4	M 42X2	30	-1242	3.07	76	1.85	45			2	50	1.1/16	27
<b>T7711-1630</b>	25	1	M 30X2	20	-1630	3.35	85	1.65	40				36	1.1/4	32
<b>T7711-1636</b>	25	1	M 36X2	25	-1636	3.50	89	1.81	42				46	1.1/4	32
<b>T7711-1642</b>	25	1	M 42X2	30	-1642	3.50	89	1.81	42			2	50	1.1/4	32
<b>T7711-2042</b>	31	1.1/4	M 42X2	30	-2042	3.54	90	1.50	38			2	50		
<b>T7711-2052</b>	31	1.1/4	M 52X2	38	-2052	3.74	95	1.69	43			2.3/8	60		
<b>T7711-2452</b>	38	1.1/2	M 52X2	38	-2452	3.94	100	1.73	44			2.3/8	60		

## T7000 SERIES ONE-PIECE CRIMP COUPLINGS

### METRIC - DKOS

### T7720

DKOS FEMALE  
24° CONE  
45° TUBE BEND

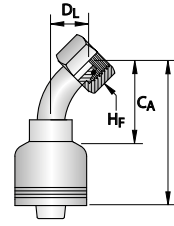

PART NO.	HOSE SIZE		THREAD SIZE	TUBE SIZE	DASH SIZE	DIMENSIONS						SPANNER		
	DN	inch	mm	mm		L		C <sub>A</sub>		D <sub>L</sub>		H <sub>F</sub>		H <sub>M</sub>
<b>T7720-0824</b>	12	1/2	M 24X1,5	16	-0824	3.19	81	2.09	53	0.94	24	1.3/16	30	
<b>T7720-1230</b>	19	3/4	M 30X2	20	-1230	4.13	103	2.91	72	1.38	35		36	
<b>T7720-1236</b>	19	3/4	M 36X2	25	-1236	4.21	105	2.99	74	1.38	35		46	
<b>T7720-1642</b>	25	1	M 42X2	30	-1642	5.12	130	3.43	85	1.46	37	2	50	
<b>T7720-2052</b>	31	1.1/4	M 52X2	38	-2052	6.22	158	4.17	106	1.89	48	2.3/8	60	

### METRIC - DKOS

### T7730

DKOS FEMALE  
24° CONE  
90° TUBE BEND

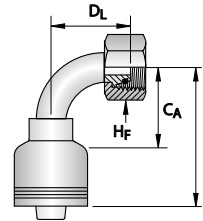

PART NO.	HOSE SIZE		THREAD SIZE	TUBE SIZE	DASH SIZE	DIMENSIONS						SPANNER		
	DN	inch	mm	mm		L		C <sub>A</sub>		D <sub>L</sub>		H <sub>F</sub>		H <sub>M</sub>
<b>T7730-0618</b>	10	3/8	M 18X1,5	10	-0618	2.20	56	1.06	27	1.18	30	7/8	22	
<b>T7730-0824</b>	12	1/2	M 24X1,5	16	-0824	2.72	69	1.61	41	1.89	48	1.3/16	30	
<b>T7730-1024</b>	16	5/8	M 24X1,5	16	-1024	3.07	78	1.77	45	1.89	48	1.3/16	30	
<b>T7730-1230</b>	19	3/4	M 30X2	20	-1230	3.54	88	2.32	57	2.68	68		36	
<b>T7730-1236</b>	19	3/4	M 36X2	25	-1236	3.54	88	2.32	57	2.68	68		46	
<b>T7730-1642</b>	25	1	M 42X2	30	-1642	4.41	112	2.72	74	3.03	77	2	50	
<b>T7730-2042</b>	31	1.1/4	M 42X2	30	-2042	4.80	122	2.76	70	3.03	77	2	50	
<b>T7730-2052</b>	31	1.1/4	M 52X2	38	-2052	5.39	137	3.35	85	3.50	89	2.3/8	60	
<b>T7730-2452</b>	38	1.1/2	M 52X2	38	-2452	5.79	147	3.58	91	3.50	89	2.3/8	60	

INTRODUCTION

INDEXES

ONE-PIECE  
COUPLINGS

PUSH-ON SUCTION &  
RETURN COUPLINGS

FIELD ATTACHABLE  
COUPLINGS

HYDRAULIC FITTINGS  
ACCESSORIES

# ONE-PIECE COUPLINGS

## T7000 SERIES ONE-PIECE CRIMP COUPLINGS

ORFS

T7840

ORFS MALE

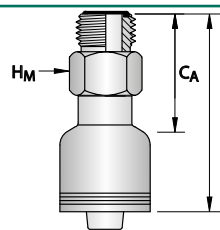

PART NO.	HOSE SIZE		THREAD SIZE	TUBE SIZE	DASH SIZE	DIMENSIONS				SPANNER					
	DN	inch	inch			L		C <sub>A</sub>		D <sub>L</sub>		H <sub>F</sub>		H <sub>M</sub>	
						inch	mm	inch	mm			inch	mm	inch	mm
T7840-0611	10	3/8	11/16" - 16		-0611	2.28	58	1.14	29					3/4	19
T7840-0813	12	1/2	13/16" - 16		-0813	2.36	60	1.30	33					7/8	22
T7840-1219	19	3/4	1.3/16" - 12		-1219	2.76	70	1.54	39					1.1/4	32
T7840-1623	25	1	1.7/16" - 12		-1623	3.31	84	1.61	41					1.1/2	38
T7840-2027	31	1.1/4	1.11/16" - 12		-2027	3.82	97	1.77	45					1.3/4	

ORFS

T7800

ORFS FEMALE

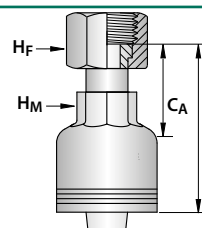

PART NO.	HOSE SIZE		THREAD SIZE	TUBE SIZE	DASH SIZE	DIMENSIONS				SPANNER					
	DN	inch	inch			L		C <sub>A</sub>		D <sub>L</sub>		H <sub>F</sub>		H <sub>M</sub>	
						inch	mm	inch	mm			inch	mm	inch	mm
T7800-0611	10	3/8	11/16" - 16		-0611	2.44	62	1.26	32			7/8	22	9/16	16
T7800-0613	10	3/8	13/16" - 16		-0613	2.56	65	1.38	35			15/16	24	9/16	16
T7800-0813	12	1/2	13/16" - 16		-0813	2.52	64	1.42	36			15/16	24	11/16	19
T7800-0816	12	1/2	1" - 14		-0816	2.64	67	1.57	40			1.1/8		15/16	24
T7800-0819	12	1/2	1.3/16" - 12		-0819	2.72	69	1.65	42			1.3/8	35	11/16	
T7800-1016	16	5/8	1" - 14		-1016	2.83	72	1.57	40			1.1/8		7/8	22
T7800-1216	19	3/4	1" - 14		-1216	2.76	73	1.54	42			1.1/8		1	
T7800-1219	19	3/4	1.3/16" - 12		-1219	3.07	72	1.85	41			1.3/8	35	1.1/16	27
T7800-1223	19	3/4	1.7/16" - 12		-1223	3.03	75	1.85	45			1.5/8	41	1.1/16	27
T7800-1623	25	1	1.7/16" - 12		-1623	3.58	91	1.89	42			1.5/8	41	1.1/4	32
T7800-1627	25	1	1.11/16" - 12		-1627	3.66	93	1.97	46			2	50	1.1/4	32
T7800-2023	31	1.1/4	1.7/16" - 12		-2023	4.41	112	2.40	61			1.5/8	41	1.5/8	41
T7800-2027	31	1.1/4	1.11/16" - 12		-2027	4.17	106	2.17	55			2	50	1.5/8	41
T7800-2432	38	1.1/2	2" - 12		-2432	4.53	115	2.32	59			2.1/4	57	2	50

## T7000 SERIES ONE-PIECE CRIMP COUPLINGS

### ORFS

### T7801

ORFS FEMALE  
METRIC NUT ONLY

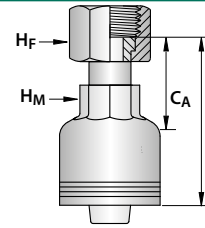

PART NO.	HOSE SIZE		THREAD SIZE	TUBE SIZE	DASH SIZE	DIMENSIONS						SPANNER			
	DN	inch	inch			L		C <sub>A</sub>		D <sub>L</sub>		H <sub>F</sub>		H <sub>M</sub>	
						inch	mm	inch	mm			inch	mm	inch	mm
T7801-0611	10	3/8	11/16" -16		-0611	2.44	62	1.26	32			7/8	22	9/16	
T7801-0816	12	1/2	1" - 14		-0816	2.60	66	1.50	38			1.3/16	30	11/16	
T7801-0819	12	1/2	1.3/16" - 12		-0819	2.72	69	1.65	42				36	11/16	
T7801-1016	16	5/8	1" - 14		-1016	2.83	72	1.57	40			1.3/16	30	7/8	22
T7801-1216	19	3/4	1" - 14		-1216	2.91	72	1.73	42			1.3/16	30	1.1/16	27
T7801-1219	19	3/4	1.3/16" - 12		-1219	3.07	72	1.85	41				36	1.1/16	27

### ORFS

### T7810

ORFS FEMALE  
45° TUBE BEND

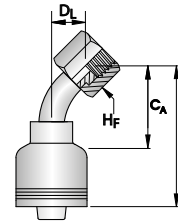

PART NO.	HOSE SIZE		THREAD SIZE	TUBE SIZE	DASH SIZE	DIMENSIONS						SPANNER			
	DN	inch	inch			L		C <sub>A</sub>		D <sub>L</sub>		H <sub>F</sub>		H <sub>M</sub>	
						inch	mm	inch	mm	inch	mm	inch	mm		mm
T7810-0611	10	3/8	11/16" -16		-0611	2.91	74	1.77	45	0.79	20	7/8	22		
T7810-0613	10	3/8	13/16" - 16		-0613	2.72	69	1.57	40	0.67	17	15/16	24		
T7810-0813	12	1/2	13/16" - 16		-0813	2.99	76	1.93	49	0.75	19	15/16	24		
T7810-0816	12	1/2	1" - 14		-0816	2.95	75	1.89	48	0.75	19	1.1/8			
T7810-1016	16	5/8	1" - 14		-1016	3.58	91	2.32	59	0.79	20	1.1/8			
T7810-1219	19	3/4	1.3/16" - 12		-1219	4.33	108	3.11	77	1.14	29	1.3/8	35		
T7810-1223	19	3/4	1.7/16" - 12		-1223	4.25	106	3.03	75	1.02	26	1.5/8	41		
T7810-1623	25	1	1.7/16" - 12		-1623	5.08	129	3.39	84	1.34	34	1.5/8	41		
T7810-1627	25	1	1.11/16" - 12		-1627	5.08	129	3.39	80	1.26	32	2	50		
T7810-2027	31	1.1/4	1.11/16" - 12		-2027	6.02	153	4.02	102	1.77	45	2	50		
T7810-2432	38	1.1/2	2" - 12		-2432	7.36	187	5.16	131	2.09	53	2.1/4	57		

# ONE-PIECE COUPLINGS

## T7000 SERIES ONE-PIECE CRIMP COUPLINGS

**ORFS**

**T7811**

ORFS FEMALE  
45° TUBE BEND  
METRIC NUT ONLY

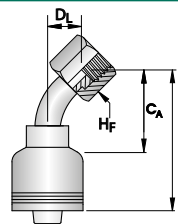

PART NO.	HOSE SIZE		THREAD SIZE	TUBE SIZE	DASH SIZE	DIMENSIONS						SPANNER			
	DN	inch	inch			L		CA		DL		HF		HM	
						inch	mm	inch	mm	inch	mm	inch	mm		
<b>T7811-0816</b>	12	1/2	1" - 14		-0816	2.99	76	1.89	48	0.75	19	1.3/16	30		
<b>T7811-1016</b>	16	5/8	1" - 14		-1016	3.62	92	2.32	59	0.79	20	1.3/16	30		

**ORFS**

**T7823**

ORFS FEMALE  
90° SHORT TUBE BEND

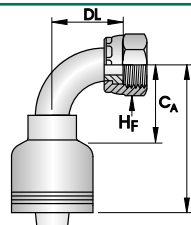

PART NO.	HOSE SIZE		THREAD SIZE	TUBE SIZE	DASH SIZE	DIMENSIONS						SPANNER			
	DN	inch	inch			L		CA		DL		HF		HM	
						inch	mm	inch	mm	inch	mm	inch	mm		
<b>T7823-1219</b>	19	3/4	1.3/16" - 12		-1219	3.54	88	2.32	57	1.89	48	1.3/8	35		
<b>T7823-1623</b>	25	1	1.7/16" - 12		-1623	4.88	124	3.19	79	2.20	56	1.5/8	41		
<b>T7823-2027</b>	31	1.1/4	1.11/16" - 12		-2027	5.94	151	3.94	100	2.52	64	2	50		

**ORFS**

**T7824**

ORFS FEMALE  
90° SHORT TUBE BEND  
METRIC NUT ONLY

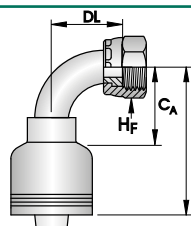

PART NO.	HOSE SIZE		THREAD SIZE	TUBE SIZE	DASH SIZE	DIMENSIONS						SPANNER			
	DN	inch	inch			L		CA		DL		HF		HM	
						inch	mm	inch	mm	inch	mm	inch	mm		
<b>T7824-1219</b>	19	3/4	1.3/16" - 12		-1219	3.54	88	2.32	57	1.89	48		36		

## T7000 SERIES ONE-PIECE CRIMP COUPLINGS

### ORFS

### T7820

ORFS FEMALE  
90° MEDIUM TUBE BEND

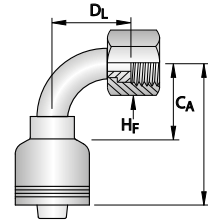

PART NO.	HOSE SIZE		THREAD SIZE	TUBE SIZE	DASH SIZE	DIMENSIONS						SPANNER			
	DN	inch	inch			L		C <sub>A</sub>		D <sub>L</sub>		H <sub>F</sub>		H <sub>M</sub>	
						inch	mm	inch	mm	inch	mm	inch	mm		mm
T7820-0611	10	3/8	11/16" -16		-0611	2.56	65	1.38	35	1.50	38	7/8	22		
T7820-0613	10	3/8	13/16" - 16		-0613	2.68	68	1.50	38	1.34	34	15/16	24		
T7820-0813	12	1/2	13/16" - 16		-0813	2.56	65	1.50	38	1.61	41	15/16	24		
T7820-0816	12	1/2	1" - 14		-0816	2.72	69	1.61	41	1.85	47	1.1/8			
T7820-0819	12	1/2	1.3/16" - 12		-0819	2.72	69	1.61	41	2.28	58	1.3/8	35		
T7820-1016	16	5/8	1" - 14		-1016	3.07	78	1.81	46	1.85	47	1.1/8			
T7820-1216	19	3/4	1" - 14		-1216	3.39	84	2.17	53	1.85	47	1.1/8			
T7820-1219	19	3/4	1.3/16" - 12		-1219	3.54	88	2.32	57	2.32	59	1.3/8	35		
T7820-1223	19	3/4	1.7/16" - 12		-1223	3.54	88	2.32	57	2.09	53	1.5/8	41		
T7820-1623	25	1	1.7/16" - 12		-1623	4.41	112	2.72	74	2.80	71	1.5/8	41		
T7820-2027	31	1.1/4	1.11/16" - 12		-2027	5.94	151	3.94	100	3.54	90	2	50		
T7820-2432	38	1.1/2	2" - 12		-2432	6.38	162	4.17	106	4.21	107	2.1/4	57		

### ORFS

### T7821

ORFS FEMALE  
90° MEDIUM TUBE BEND  
METRIC NUT ONLY

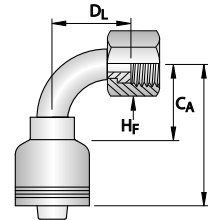

PART NO.	HOSE SIZE		THREAD SIZE	TUBE SIZE	DASH SIZE	DIMENSIONS						SPANNER			
	DN	inch	inch			L		C <sub>A</sub>		D <sub>L</sub>		H <sub>F</sub>		H <sub>M</sub>	
						inch	mm	inch	mm	inch	mm	inch	mm		mm
T7821-0816	12	1/2	1" - 14		-0816	2.72	69	1.61	41	1.85	47	1.3/16	30		
T7821-0819	12	1/2	1.3/16" - 12		-0819	2.72	69	1.61	41	2.28	58		36		
T7821-1016	16	5/8	1" - 14		-1016	3.07	78	1.77	45	1.85	47	1.3/16	30		
T7821-1216	19	3/4	1" - 14		-1216	3.39	86	2.17	55	1.85	47	1.3/16	30		
T7821-1219	19	3/4	1.3/16" - 12		-1219	3.54	88	2.32	57	2.32	59		36		

# ONE-PIECE COUPLINGS

## T7000 SERIES ONE-PIECE CRIMP COUPLINGS

**ORFS**

**T7830**

ORFS FEMALE  
90° LONG TUBE BEND

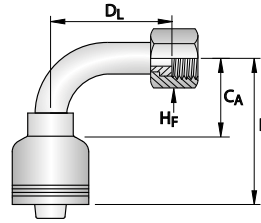

PART NO.	HOSE SIZE		THREAD SIZE	TUBE SIZE	DASH SIZE	DIMENSIONS						SPANNER			
	DN	inch	inch			L		CA		DL		HF		HM	
	DN	inch	inch			inch	mm	inch	mm	inch	mm	inch	mm		
T7830-0611	10	3/8	11/16" -16		-0611	2.44	62	1.30	33	2.17	55	7/8	22		
T7830-0813	12	1/2	13/16" - 16		-0813	2.76	70	1.69	43	2.56	65	15/16	24		
T7830-1219	19	3/4	1.3/16" - 12		-1219	3.50	88	2.28	57	3.78	96	1.3/8	35		
T7830-1623	25	1	1.7/16" - 12		-1623	4.61	117	2.91	74	4.45	113	1.5/8	41		
T7830-2027	31	1.1/4	1.11/16" - 12		-2027	5.94	151	3.94	100	5.08	129	2	50		

**ORFS**

**T7831**

ORFS FEMALE  
90° LONG TUBE BEND  
METRIC NUT ONLY

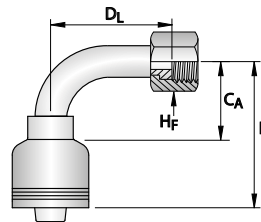

PART NO.	HOSE SIZE		THREAD SIZE	TUBE SIZE	DASH SIZE	DIMENSIONS						SPANNER			
	DN	inch	inch			L		CA		DL		HF		HM	
	DN	inch	inch			inch	mm	inch	mm	inch	mm	inch	mm		
T7831-1219	19	3/4	1.3/16" - 12		-1219	3.54	88	2.32	57	3.78	96		36		

**RYCOLOK**

**T7870**

RYCOLOK MALE  
STAPLE

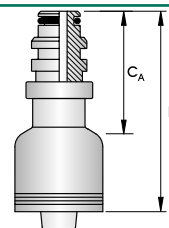

PART NO.	HOSE SIZE		THREAD SIZE	TUBE SIZE	DASH SIZE	DIMENSIONS						SPANNER			
	DN	inch	inch			L		CA		DL		HF		HM	
	DN	inch	inch			inch	mm	inch	mm						
T7870-0610	10	3/8		10	-0610	2.64	67	1.50	38						
T7870-0812	12	1/2		12	-0812	2.68	68	1.61	41						
T7870-1016	16	5/8		16	-1016	2.80	71	1.54	39						
T7870-1220	19	3/4		20	-1220	2.76	70	1.54	39						
T7870-1625	25	1		25	-1625	3.66	93	1.97	50						
T7870-2032	31	1.1/4		32	-2032	4.02	102	1.97	50						
T7870-2440	38	1.1/2		40	-2440	4.57	116	2.36	60						
T7870-3250	51	2		50	-3250	4.72	120	2.28	58						
T7870-4063	63	2.1/2		63	-4063	6.57	167	3.54	90						

## T7000 SERIES ONE-PIECE CRIMP COUPLINGS

### RYCOLOK

### T7871

RYCOLOK MALE  
45° ELBOW  
STAPLE

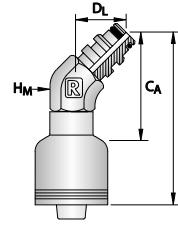

PART NO.	HOSE SIZE		THREAD SIZE	TUBE SIZE	DASH SIZE	DIMENSIONS						SPANNER			
	DN	inch				inch	inch	mm	inch	mm	inch	mm	inch	mm	
T7871-0610	10	3/8		10	-0610	2.91	74	1.77	45	1.06	27			7/8	22
T7871-0812	12	1/2		12	-0812	3.09	79	2.02	51	1.07	27				
T7871-1220	19	3/4		20	-1220	3.26	83	2.05	52	1.27	32				
T7871-1625	25	1		25	-1625	4.13	105	2.46	62	1.43	36				
T7871-2032	31	1.1/4		32	-2032	4.57	116	2.53	64	1.43	36				
T7871-2440	38	1.1/2		40	-2440	5.43	138	3.23	82	1.73	44				
T7871-3250	51	2		50	-3250	5.91	150	3.43	87	1.81	46				

### RYCOLOK

### T7872

RYCOLOK MALE  
90° ELBOW  
STAPLE

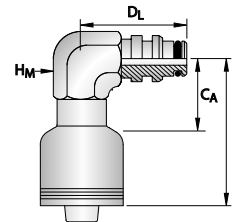

PART NO.	HOSE SIZE		THREAD SIZE	TUBE SIZE	DASH SIZE	DIMENSIONS						SPANNER			
	DN	inch				mm	inch	mm	inch	mm	inch	mm	inch	mm	
T7872-0610	10	3/8		10	-0610	2.05	52	0.91	23	1.81	46			7/8	22
T7872-0812	12	1/2		12	-0812	2.22	57	1.15	29	1.99	51				
T7872-1016	16	5/8		16	-1016	2.37	60	1.11	28	2.07	53				
T7872-1220	19	3/4		20	-1220	2.40	61	1.19	30	2.19	56				
T7872-1625	25	1		25	-1625	3.29	84	1.60	41	2.68	68				
T7872-2032	31	1.1/4		32	-2032	3.72	95	1.68	43	2.68	68				
T7872-2440	38	1.1/2		40	-2440	4.61	117	2.40	61	3.35	85				

# ONE-PIECE COUPLINGS

## T7000 SERIES ONE-PIECE CRIMP COUPLINGS

### RYCO SUPERLOK

### T7876

RYCO SUPERLOK MALE  
STAPLE

O RING & BACK UP RING SUPPLIED

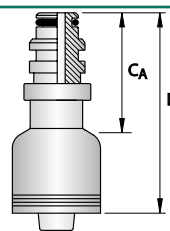

PART NO.	HOSE SIZE		THREAD SIZE	TUBE SIZE	DASH SIZE	DIMENSIONS				SPANNER			
	DN	inch				inch	inch	mm	inch	mm	inch	mm	inch
T7876-0812	12	1/2		12	-0812	2.83	72	1.77	45				
T7876-1220	19	3/4		20	-1220	3.11	79	1.89	48				
T7876-1625	25	1		25	-1625	4.37	111	2.68	68				
T7876-2032	31	1.1/4		32	-2032	4.80	122	2.76	70				
T7876-2440	38	1.1/2		40	-2440	5.31	135	3.07	78				
T7876-3250	51	2		50	-3250	5.55	141	3.11	79				

### RYCO WEO

### T7480

RYCO WEO MALE

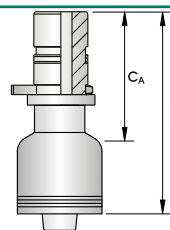

PART NO.	HOSE SIZE		THREAD SIZE	TUBE SIZE	DASH SIZE	DIMENSIONS				SPANNER			
	DN	inch				inch	inch	mm	inch	mm	inch	mm	inch
T7480-0606	10	3/8		3/8	-0606	2.52	64	1.38	35				
T7480-0808	12	1/2		1/2	-0808	2.48	63	1.42	36				
T7480-1012	16	5/8		3/4	-1012	3.03	77	1.73	44				
T7480-1212	19	3/4		3/4	-1212	2.99	76	1.77	45				
T7480-1616	25	1		1	-1616	3.90	99	2.20	56				

### RYCO WEO

### T7482

RYCO WEO MALE  
45° TUBE BEND

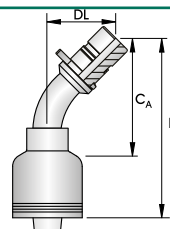

PART NO.	HOSE SIZE		THREAD SIZE	TUBE SIZE	DASH SIZE	DIMENSIONS				SPANNER			
	DN	inch				inch	inch	mm	inch	mm	inch	mm	inch
T7482-0606	10	3/8		3/8	-0606	3.31	84	2.17	55	1.06	27		
T7482-0808	12	1/2		1/2	-0808	3.39	86	2.32	59	1.22	31		
T7482-1012	16	5/8		3/4	-1012	4.09	104	2.83	72	1.57	40		
T7482-1212	19	3/4		3/4	-1212	4.45	113	3.23	82	1.69	43		

## T7000 SERIES ONE-PIECE CRIMP COUPLINGS

**RYCO WEO**

**T7483**

RYCO WEO MALE  
90° TUBE BEND

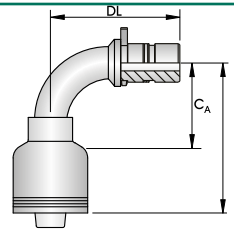

PART NO.	HOSE SIZE		THREAD SIZE	TUBE SIZE	DASH SIZE	DIMENSIONS						SPANNER	
	DN	inch		inch		L		C <sub>A</sub>		D <sub>L</sub>		H <sub>F</sub>	H <sub>M</sub>
						inch	mm	inch	mm	inch	mm		
<b>T7483-0606</b>	10	3/8		3/8	-0606	2.52	64	1.38	35	2.05	52		
<b>T7483-0808</b>	12	1/2		1/2	-0808	2.56	65	1.50	38	2.28	58		
<b>T7483-1012</b>	16	5/8		3/4	-1012	3.39	86	2.13	54	3.23	82		
<b>T7483-1212</b>	19	3/4		3/4	-1212	3.35	85	2.13	54	3.23	82		
<b>T7483-1616</b>	25	1		1	-1616	4.53	115	2.83	72	3.82	97		

INTRODUCTION

INDEXES

ONE-PIECE  
COUPLINGS

PUSH-ON SUCTION &  
RETURN COUPLINGS

FIELD ATTACHABLE  
COUPLINGS

HYDRAULIC FITTINGS  
ACCESSORIES

# ONE-PIECE COUPLINGS

## T7000 SERIES ONE-PIECE CRIMP COUPLINGS

### DIMENSIONS FOR SAE CODE 61 AND CODE 62 FLANGES, AND RYCO CODE 62C FLANGES

NOMINAL FLANGE	CODE 61				CODE 62				CODE 62C			
	B		T		B		T		B		T	
inch	mm	inch	mm	inch	mm	inch	mm	inch	mm	inch	mm	inch
1/2	30,2	1.19	6,73	0.265	31,8	1.25	7,75	0.305				
5/8	34,0	1.34	6,73	0.265								
3/4	38,1	1.50	6,73	0.265	41,3	1.63	8,76	0.345	41,3	1.63	14,20	0.559
1	44,5	1.75	8,00	0.315	47,6	1.88	9,53	0.375	47,6	1.88	14,20	0.559
1.1/4	50,8	2.00	8,00	0.315	54,0	2.12	10,29	0.405	54,0	2.12	14,20	0.559
1.1/2	60,3	2.38	8,00	0.315	63,5	2.50	12,57	0.495	63,5	2.50	14,20	0.559
2	71,4	2.81	9,53	0.375	79,4	3.13	12,57	0.495	79,4	3.13	14,20	0.559
2.1/2	84,1	3.31	9,53	0.375								
3	101,6	4.00	9,53	0.375								

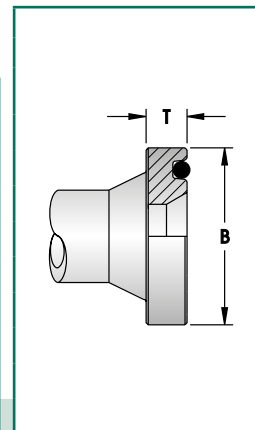

**NOTE:** Ryco Code 62C fittings conform to the flange OD and bolt hole patterns of SAE Code 62 but require special flange clamps. Ryco Code 62C flange heads are thicker than SAE Code 62 and measure T = 14,2 mm (0.559 inch) in all sizes.

### SAE FLANGE

### T7130

**SAE CODE 61 FLANGE**  
O RING NOT SUPPLIED

CLAMPS - SEE PAGES 274 & 282

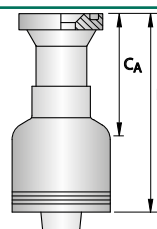

PART NO.	HOSE SIZE		THREAD SIZE	TUBE SIZE	DASH SIZE	DIMENSIONS				SPANNER			
	DN	inch				L		C <sub>A</sub>		D <sub>L</sub>		H <sub>F</sub>	
						inch	mm	inch	mm				
T7130-0808	12	1/2			-0808	2.83	72	1.77	45				
T7130-0812	12	1/2			-0812	2.95	75	1.89	48				
T7130-1210	19	3/4			-1210	2.99	76	1.77	45				
T7130-1212	19	3/4			-1212	3.03	77	1.81	46				
T7130-1216	19	3/4			-1216	3.19	81	1.97	50				
T7130-1220	19	3/4			-1220	3.46	88	2.24	57				
T7130-1616	25	1			-1616	3.74	95	2.05	52				
T7130-1620	25	1			-1620	3.94	100	2.24	57				
T7130-1624	25	1			-1624	5.00	127	3.31	84				
T7130-2016	31	1.1/4			-2016	4.17	106	2.13	54				
T7130-2020	31	1.1/4			-2020	4.37	111	2.32	59				
T7130-2024	31	1.1/4			-2024	5.35	136	3.35	85				
T7130-2420	38	1.1/2			-2420	4.57	116	2.36	60				
T7130-2424	38	1.1/2			-2424	5.59	142	3.39	86				
T7130-2432	38	1.1/2			-2432	5.98	152	3.78	96				
T7130-3232	51	2			-3232	6.26	159	3.78	96				
T7130-3240	51	2			-3240	6.46	164	3.98	101				
T7130-4040	63	2.1/2			-4040	6.14	156	3.11	79				

## T7000 SERIES ONE-PIECE CRIMP COUPLINGS

### SAE FLANGE

### T7140

SAE CODE 61 FLANGE  
22.5° TUBE BEND  
O RING NOT SUPPLIED

CLAMPS - SEE PAGES 274 & 282

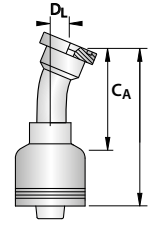

PART NO.	HOSE SIZE		THREAD SIZE	TUBE SIZE	DASH SIZE	DIMENSIONS						SPANNER	
	DN	inch				L		C <sub>A</sub>		D <sub>L</sub>		H <sub>F</sub>	H <sub>M</sub>
	DN	inch	inch			inch	mm	inch	mm	inch	mm		
T7140-1212	19	3/4			-1212	4.06	103	2.83	72	0.47	12		
T7140-1216	19	3/4			-1216	4.17	106	2.95	75	0.59	15		
T7140-1616	25	1			-1616	5.12	130	3.43	87	0.55	14		
T7140-1620	25	1			-1620	5.12	130	3.43	87	0.51	13		
T7140-2020	31	1.1/4			-2020	6.22	158	4.17	106	0.63	16		
T7140-2024	31	1.1/4			-2024	6.34	161	4.29	109	0.79	20		
T7140-2424	38	1.1/2			-2424	6.85	174	4.65	118	0.94	24		
T7140-2432	38	1.1/2			-2432	7.48	190	5.28	134	1.06	27		
T7140-3232	51	2			-3232	8.86	225	6.38	162	0.98	25		

### SAE - FLANGE

### T7150

SAE CODE 61 FLANGE  
45° TUBE BEND

CLAMPS - SEE PAGES 274 & 282

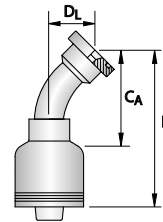

PART NO.	HOSE SIZE		THREAD SIZE	TUBE SIZE	DASH SIZE	DIMENSIONS						SPANNER	
	DN	inch				inch			inch	mm	inch	mm	inch
T7150-0808	12	1/2	-		-0808	2.99	76	1.93	49	0.79	20		
T7150-0812	12	1/2	-		-0812	3.07	78	2.01	51	0.94	24		
T7150-1210	19	3/4	-		-1210	3.54	90	2.32	59	1.02	26		
T7150-1212	19	3/4	-		-1212	3.78	96	2.56	65	1.02	26		
T7150-1216	19	3/4	-		-1216	3.90	99	2.68	68	1.18	30		
T7150-1616	25	1	-		-1616	4.88	124	3.19	81	1.18	30		
T7150-1620	25	1	-		-1620	4.96	126	3.27	83	1.26	32		
T7150-2016	31	1.1/4	-		-2016	5.51	140	3.46	88	1.18	30		
T7150-2020	31	1.1/4	-		-2020	5.98	152	3.94	100	1.42	36		
T7150-2024	31	1.1/4	-		-2024	6.10	155	4.06	103	1.57	40		

# ONE-PIECE COUPLINGS

## T7000 SERIES ONE-PIECE CRIMP COUPLINGS

### SAE FLANGE

### T7300

SAE CODE 61 FLANGE  
60° TUBE BEND  
O RING NOT SUPPLIED

CLAMPS - SEE PAGES 274 & 282

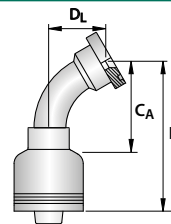

PART NO.	HOSE SIZE		THREAD SIZE	TUBE SIZE	DASH SIZE	DIMENSIONS						SPANNER	
	DN	inch				L		CA		DL		HF	HM
						inch	mm	inch	mm	inch	mm		
<b>T7300-1212</b>	19	3/4			-1212	4.29	109	3.07	78	1.46	37		
<b>T7300-1216</b>	19	3/4			-1216	4.37	111	3.15	80	1.61	41		
<b>T7300-1616</b>	25	1			-1616	5.43	138	3.74	95	1.77	45		
<b>T7300-1620</b>	25	1			-1620	5.51	140	3.82	97	1.77	45		
<b>T7300-2020</b>	31	1.1/4			-2020	6.50	165	4.45	113	2.01	51		
<b>T7300-2024</b>	31	1.1/4			-2024	6.81	173	4.76	121	2.13	54		
<b>T7300-2424</b>	38	1.1/2			-2424	7.68	195	5.47	139	2.36	60		
<b>T7300-2432</b>	38	1.1/2			-2432	7.99	203	5.79	147	2.68	68		
<b>T7300-3232</b>	51	2			-3232	9.13	232	6.65	169	3.66	93		

### SAE FLANGE

### T7290

SAE CODE 61 FLANGE  
30° TUBE BEND  
O RING NOT SUPPLIED

CLAMPS - SEE PAGES 274 & 282

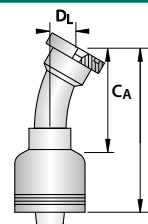

PART NO.	HOSE SIZE		THREAD SIZE	TUBE SIZE	DASH SIZE	DIMENSIONS						SPANNER	
	DN	inch				L		CA		DL		HF	HM
						inch	mm	inch	mm	inch	mm		
<b>T7290-1212</b>	19	3/4			-1212	3.98	101	2.76	70	0.71	18		
<b>T7290-1616</b>	25	1			-1616	5.04	128	3.35	85	0.71	18		
<b>T7290-2020</b>	31	1.1/4			-2020	6.14	156	4.09	104	0.79	20		
<b>T7290-2024</b>	31	1.1/4			-2024	6.42	163	4.37	111	0.94	24		
<b>T7290-2424</b>	38	1.1/2			-2424	6.85	174	4.65	118	1.02	26		
<b>T7290-2432</b>	38	1.1/2			-2432	7.32	186	5.12	130	1.26	32		
<b>T7290-3232</b>	51	2			-3232	8.62	219	6.14	156	1.57	40		

## T7000 SERIES ONE-PIECE CRIMP COUPLINGS

### SAE FLANGE

### T7160

SAE CODE 61 FLANGE  
67.5° TUBE BEND  
O RING NOT SUPPLIED

CLAMPS - SEE PAGES 274 & 282

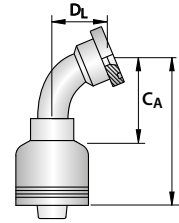

PART NO.	HOSE SIZE		THREAD SIZE	TUBE SIZE	DASH SIZE	DIMENSIONS						SPANNER	
	DN	inch				L		CA		DL		HF	HM
						inch	mm	inch	mm	inch	mm		
T7160-1212	19	3/4			-1212	4.06	103	2.83	72	1.77	45		
T7160-1216	19	3/4			-1216	4.09	104	2.87	73	1.93	49		
T7160-1616	25	1			-1616	5.16	131	3.46	88	1.93	49		
T7160-1620	25	1			-1620	5.16	131	3.46	88	2.05	52		
T7160-2020	31	1.1/4			-2020	6.02	153	3.98	101	2.64	67		
T7160-2024	31	1.1/4			-2024	6.34	161	4.29	109	2.52	64		
T7160-2424	38	1.1/2			-2424	7.48	190	5.28	134	2.76	70		
T7160-2432	38	1.1/2			-2432	7.48	190	5.28	134	3.11	79		
T7160-3232	51	2			-3232	9.09	231	6.61	168	3.74	95		

### SAE FLANGE

### T7170

SAE CODE 61 FLANGE  
90° TUBE BEND  
O RING NOT SUPPLIED

CLAMPS - SEE PAGES 274 & 282

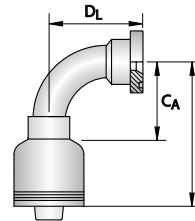

PART NO.	HOSE SIZE		THREAD SIZE	TUBE SIZE	DASH SIZE	DIMENSIONS						SPANNER	
	DN	inch				L		CA		DL		HF	HM
						inch	mm	inch	mm	inch	mm		
T7170-0808	12	1/2			-0808	2.64	67	1.57	40	1.61	41		
T7170-0812	12	1/2			-0812	2.64	67	1.57	40	1.81	46		
T7170-1210	19	3/4			-1210	3.23	82	2.01	51	1.89	48		
T7170-1212	19	3/4			-1212	3.39	86	2.17	55	2.13	54		
T7170-1216	19	3/4			-1216	3.39	86	2.17	55	2.36	60		
T7170-1612	25	1			-1612	4.06	103	2.36	60	2.13	54		
T7170-1616	25	1			-1616	4.37	111	2.68	68	2.68	68		
T7170-1620	25	1			-1620	4.45	113	2.76	70	2.72	69		
T7170-1624	25	1			-1624	4.37	111	2.68	68	2.87	73		
T7170-2016	31	1.1/4			-2016	5.12	130	3.07	78	2.68	68		
T7170-2020	31	1.1/4			-2020	5.20	132	3.15	80	3.07	78		
T7170-2024	31	1.1/4			-2024	5.59	142	3.54	90	3.19	81		
T7170-2424	38	1.1/2			-2424	6.30	160	4.09	104	3.66	93		
T7170-2432	38	1.1/2			-2432	6.02	153	3.82	97	3.90	99		
T7170-3232	51	2			-3232	7.87	200	5.39	137	5.12	130		
T7170-3240	51	2			-3240	8.03	204	5.55	141	5.28	134		

# ONE-PIECE COUPLINGS

## T7000 SERIES ONE-PIECE CRIMP COUPLINGS

### SAE FLANGE

### T7171

SAE CODE 61 FLANGE  
90° SPECIAL TUBE BEND  
O RING NOT SUPPLIED

CLAMPS - SEE PAGES 274 & 282

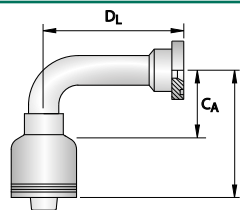

PART NO.	HOSE SIZE		THREAD SIZE	TUBE SIZE	DASH SIZE	DIMENSIONS						SPANNER	
	DN	inch				L		C <sub>A</sub>		D <sub>L</sub>		H <sub>F</sub>	H <sub>M</sub>
						inch	mm	inch	mm	inch	mm		
T7171-0812	12	1/2			-0812	3.07	78	2.01	51	2.87	73		
T7171-1216	19	3/4			-1216	3.39	86	2.17	55	3.11	79		
T7171-2024	31	1.1/4			-2024	5.35	136	3.31	84	3.19	81		
T7171-2432	38	1.1/2			-2432	6.26	159	4.06	103	4.49	114		
T7171-3232	51	2			-3232	7.91	201	5.43	138	6.50	165		
T7171-3240	51	2			-3240	8.03	204	5.55	141	4.49	114		

### SAE FLANGE

### T7172

SAE CODE 61 FLANGE  
90° SPECIAL TUBE BEND  
O RING NOT SUPPLIED

CLAMPS - SEE PAGES 274 & 282

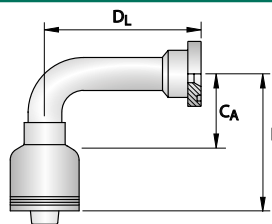

PART NO.	HOSE SIZE		THREAD SIZE	TUBE SIZE	DASH SIZE	DIMENSIONS						SPANNER	
	DN	inch				L		C <sub>A</sub>		D <sub>L</sub>		H <sub>F</sub>	H <sub>M</sub>
						inch	mm	inch	mm	inch	mm		
T7172-1212	19	3/4			-1212	3.43	87	2.20	56	3.74	95		
T7172-1616	25	1			-1616	4.49	114	2.80	71	2.64	67		
T7172-1624	25	1			-1624	4.37	111	2.68	68	4.25	108		
T7172-2020	31	1.1/4			-2020	5.35	136	3.31	84	3.62	92		
T7172-2024	31	1.1/4			-2024	5.51	140	3.46	88	4.65	118		
T7172-2424	38	1.1/2			-2424	6.26	159	4.06	103	5.83	148		

### SAE

### T7173

SAE CODE 61 FLANGE  
90° LONG TUBE BEND  
O RING NOT SUPPLIED

CLAMPS - SEE PAGES 274 & 282

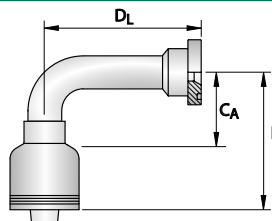

PART NO.	HOSE SIZE		THREAD SIZE	TUBE SIZE	DASH SIZE	DIMENSIONS						SPANNER	
	DN	inch				L		C <sub>A</sub>		D <sub>L</sub>		H <sub>F</sub>	H <sub>M</sub>
						inch	mm	inch	mm	inch	mm		
T7173-1212	19	3/4			-1212	3.50	89	2.32	59	3.07	78		
T7173-1616	25	1			-1616	4.49	114	2.80	71	3.70	94		
T7173-1620	25	1			-1620	4.33	110	2.64	67	3.66	93		
T7173-2020	31	1.1/4			-2020	5.20	132	3.15	80	4.25	108		

## T7000 SERIES ONE-PIECE CRIMP COUPLINGS

### SAE FLANGE

### T7174

SAE CODE 61 FLANGE  
90° SPECIAL TUBE BEND  
O RING NOT SUPPLIED

CLAMPS - SEE PAGES 274 & 282

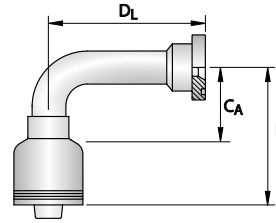

PART NO.	HOSE SIZE		THREAD SIZE	TUBE SIZE	DASH SIZE	DIMENSIONS						SPANNER	
	DN	inch				L		C <sub>A</sub>		D <sub>L</sub>		H <sub>F</sub>	H <sub>M</sub>
	DN	inch				inch	mm	inch	mm	inch	mm		
T7174-1212	19	3/4			-1212	3.39	86	2.17	55	3.78	96		
T7174-1616	25	1			-1616	4.45	113	2.76	70	4.65	118		
T7174-1620	25	1			-1620	4.37	111	2.68	68	4.65	118		
T7174-2020	31	1.1/4			-2020	5.39	137	3.35	85	5.12	130		
T7174-2424	38	1.1/2			-2424	6.06	154	3.86	98	5.83	148		
T7174-2432	38	1.1/2			-2432	6.30	160	4.09	104	6.77	172		
T7174-3232	51	2			-3232	8.03	204	5.55	141	7.99	203		

### SAE FLANGE

### T7910

SAE CODE 61 FLANGE  
110° TUBE BEND  
O RING NOT SUPPLIED

CLAMPS - SEE PAGES 274 & 282

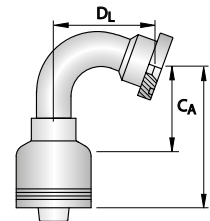

PART NO.	HOSE SIZE		THREAD SIZE	TUBE SIZE	DASH SIZE	DIMENSIONS						SPANNER	
	DN	inch				L		C <sub>A</sub>		D <sub>L</sub>		H <sub>F</sub>	H <sub>M</sub>
	DN	inch				inch	mm	inch	mm	inch	mm		
T7910-1212	19	3/4			-1212	4.06	103	2.87	73	2.64	67		
T7910-1616	25	1			-1616	4.92	125	3.23	82	3.15	80		
T7910-1620	25	1			-1620	4.92	125	3.23	82	3.35	85		
T7910-2020	31	1.1/4			-2020	5.59	142	3.54	90	3.74	95		
T7910-2024	31	1.1/4			-2024	5.59	142	3.54	90	3.86	98		
T7910-2424	38	1.1/2			-2424	8.03	204	5.83	148	4.57	116		
T7910-2432	38	1.1/2			-2432	8.07	205	5.87	149	4.84	123		
T7910-3232	51	2			-3232	7.76	197	5.28	134	5.98	152		

INTRODUCTION

INDEXES

ONE-PIECE COUPLINGS

PUSH-ON SUCTION & RETURN COUPLINGS

FIELD ATTACHABLE COUPLINGS

HYDRAULIC FITTINGS ACCESSORIES

# ONE-PIECE COUPLINGS

## T7000 SERIES ONE-PIECE CRIMP COUPLINGS

### SAE FLANGE

### T7330

SAE CODE 62 FLANGE  
O RING NOT SUPPLIED

CLAMPS - SEE PAGES 274 & 282

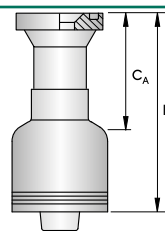

PART NO.	HOSE SIZE		THREAD SIZE	TUBE SIZE	DASH SIZE	DIMENSIONS				SPANNER			
	DN	inch				L		C <sub>A</sub>		D <sub>L</sub>		H <sub>F</sub>	H <sub>M</sub>
					inch	mm	inch	mm	inch	mm			
T7330-0808	12	1/2			-0808	2.87	73	1.81	46				
T7330-0812	12	1/2			-0812	3.31	84	2.24	57				
T7330-1008	16	5/8			-1008	3.07	78	1.77	45				
T7330-1012	16	5/8			-1012	3.46	88	2.20	56				
T7330-1212	19	3/4			-1212	3.23	82	2.01	51				
T7330-1216	19	3/4			-1216	3.35	85	2.13	54				
T7330-1612	25	1			-1612	3.78	96	2.09	53				
T7330-1616	25	1			-1616	3.90	99	2.20	56				
T7330-1620	25	1			-1620	4.33	110	2.64	67				
T7330-2016	31	1.1/4			-2016	4.76	121	2.72	69				
T7330-2020	31	1.1/4			-2020	4.76	121	2.72	69				
T7330-2024	31	1.1/4			-2024	5.94	151	3.90	99				
T7330-2424	38	1.1/2			-2424	6.14	156	3.94	100				
T7330-2432	38	1.1/2			-2432	6.85	174	4.61	117				
T7330-3232	51	2			-3232	7.09	180	4.65	118				

### SAE CODE 62

### T7440

SAE CODE 62 FLANGE  
22.5° TUBE BEND  
O RING NOT SUPPLIED

CLAMPS - SEE PAGES 274 & 282

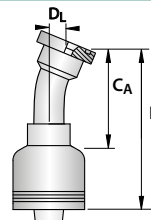

PART NO.	HOSE SIZE		THREAD SIZE	TUBE SIZE	DASH SIZE	DIMENSIONS				SPANNER			
	DN	inch				L		C <sub>A</sub>		D <sub>L</sub>		H <sub>F</sub>	H <sub>M</sub>
					inch	mm	inch	mm	inch	mm			
T7440-1212	19	3/4			-1212	3.98	101	2.76	70	0.47	12		
T7440-1216	19	3/4			-1216	4.29	109	3.07	78	0.55	14		
T7440-1616	25	1			-1616	5.20	132	3.50	89	0.63	16		
T7440-2020	31	1.1/4			-2020	6.26	159	4.21	107	0.67	17		
T7440-2024	31	1.1/4			-2024	6.61	168	4.57	116	0.87	22		
T7440-2424	38	1.1/2			-2424	7.17	182	4.96	126	0.94	24		
T7440-3232	51	2			-3232	8.86	225	6.38	162	1.10	28		

## T7000 SERIES ONE-PIECE CRIMP COUPLINGS

### SAE FLANGE

### T7450

SAE CODE 62 FLANGE  
30° TUBE BEND  
O RING NOT SUPPLIED

CLAMPS - SEE PAGES 274 & 282

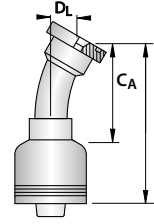

PART NO.	HOSE SIZE		THREAD SIZE	TUBE SIZE	DASH SIZE	DIMENSIONS						SPANNER	
	DN	inch				L		C <sub>A</sub>		D <sub>L</sub>		H <sub>F</sub>	H <sub>M</sub>
						inch	mm	inch	mm	inch	mm		
<b>T7450-1212</b>	19	3/4			-1212	4.09	104	2.87	73	0.75	19		
<b>T7450-1616</b>	25	1			-1616	5.16	131	3.46	88	0.87	22		
<b>T7450-1620</b>	25	1			-1620	5.24	133	3.54	90	0.87	22		
<b>T7450-2020</b>	31	1.1/4			-2020	6.30	160	4.25	108	0.87	22		
<b>T7450-2024</b>	31	1.1/4			-2024	6.46	164	4.41	112	0.98	25		
<b>T7450-2424</b>	38	1.1/2			-2424	7.09	180	4.88	124	1.30	33		

### SAE FLANGE

### T7350

SAE CODE 62 FLANGE  
45° TUBE BEND  
O RING NOT SUPPLIED

CLAMPS - SEE PAGES 274 & 282

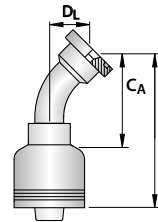

PART NO.	HOSE SIZE		THREAD SIZE	TUBE SIZE	DASH SIZE	DIMENSIONS						SPANNER	
	DN	inch				L		C <sub>A</sub>		D <sub>L</sub>		H <sub>F</sub>	H <sub>M</sub>
						inch	mm	inch	mm	inch	mm		
<b>T7350-0808</b>	12	1/2			-0808	2.99	76	1.93	49	0.79	20		
<b>T7350-1212</b>	19	3/4			-1212	3.82	97	2.60	66	1.10	28		
<b>T7350-1216</b>	19	3/4			-1216	3.98	101	2.76	70	1.22	31		
<b>T7350-1612</b>	25	1			-1612	4.65	118	2.95	75	1.10	28		
<b>T7350-1616</b>	25	1			-1616	4.92	125	3.23	82	1.22	31		
<b>T7350-1620</b>	25	1			-1620	5.04	128	3.35	85	1.34	34		
<b>T7350-2016</b>	31	1.1/4			-2016	5.55	141	3.50	89	1.26	32		
<b>T7350-2020</b>	31	1.1/4			-2020	5.91	150	3.86	98	1.50	38		
<b>T7350-2024</b>	31	1.1/4			-2024	6.06	154	4.02	102	1.61	41		
<b>T7350-2424</b>	38	1.1/2			-2424	6.65	169	4.45	113	1.73	44		
<b>T7350-2432</b>	38	1.1/2			-2432	6.93	176	4.72	120	2.13	54		
<b>T7350-3232</b>	51	2			-3232	8.46	215	5.98	152	2.36	60		

INTRODUCTION

INDEXES

ONE-PIECE COUPLINGS

PUSH-ON SUCTION & RETURN COUPLINGS

FIELD ATTACHABLE COUPLINGS

HYDRAULIC FITTINGS ACCESSORIES

# ONE-PIECE COUPLINGS

## T7000 SERIES ONE-PIECE CRIMP COUPLINGS

### SAE FLANGE

### T7460

SAE CODE 62 FLANGE  
60° TUBE BEND  
O RING NOT SUPPLIED

CLAMPS - SEE PAGES 274 & 282

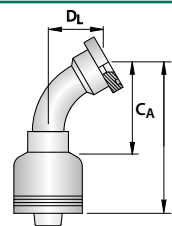

PART NO.	HOSE SIZE		THREAD SIZE	TUBE SIZE	DASH SIZE	DIMENSIONS						SPANNER	
	DN	inch				L		C <sub>A</sub>		D <sub>L</sub>		H <sub>F</sub>	H <sub>M</sub>
						inch	mm	inch	mm	inch	mm		
T7460-1212	19	3/4			-1212	4.37	111	3.15	80	1.42	36		
T7460-1216	19	3/4			-1216	4.45	113	3.23	82	1.65	42		
T7460-1616	25	1			-1616	5.47	139	3.78	96	1.73	44		
T7460-1620	25	1			-1620	5.51	140	3.82	97	1.81	46		
T7460-2020	31	1.1/4			-2020	6.65	169	4.61	117	2.01	51		
T7460-2024	31	1.1/4			-2024	6.85	174	4.80	122	2.28	58		
T7460-2424	38	1.1/2			-2424	7.72	196	5.51	140	2.52	64		

### SAE FLANGE

### T7360

SAE CODE 62 FLANGE  
67.5° TUBE BEND  
O RING NOT SUPPLIED

CLAMPS - SEE PAGES 274 & 282

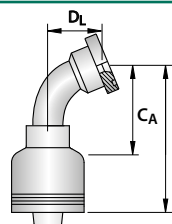

PART NO.	HOSE SIZE		THREAD SIZE	TUBE SIZE	DASH SIZE	DIMENSIONS						SPANNER	
	DN	inch				L		C <sub>A</sub>		D <sub>L</sub>		H <sub>F</sub>	H <sub>M</sub>
						inch	mm	inch	mm	inch	mm		
T7360-1212	19	3/4			-1212	4.09	104	2.87	73	1.85	47		
T7360-1216	19	3/4			-1216	4.13	105	2.91	74	1.89	48		
T7360-1616	25	1			-1616	4.84	123	3.15	80	2.01	51		
T7360-1620	25	1			-1620	4.88	124	3.19	81	2.13	54		
T7360-2020	31	1.1/4			-2020	6.50	165	4.45	113	2.83	72		
T7360-2024	31	1.1/4			-2024	6.06	154	4.02	102	2.91	74		

## T7000 SERIES ONE-PIECE CRIMP COUPLINGS

### SAE FLANGE

### T7370

SAE CODE 62 FLANGE  
90° TUBE BEND  
O RING NOT SUPPLIED

CLAMPS - SEE PAGES 274 & 282

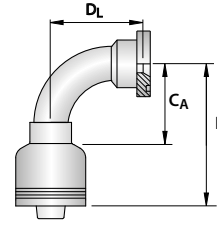

PART NO.	HOSE SIZE		THREAD SIZE	TUBE SIZE	DASH SIZE	DIMENSIONS						SPANNER	
	DN	inch				L		C <sub>A</sub>		D <sub>L</sub>		H <sub>F</sub>	H <sub>M</sub>
						inch	mm	inch	mm	inch	mm		
<b>T7370-0808</b>	12	1/2			-0808	2.72	69	1.65	42	1.61	41		
<b>T7370-0812</b>	12	1/2			-0812	2.72	69	1.65	42	1.81	46		
<b>T7370-1008</b>	16	5/8			-1008	2.99	76	1.73	44	1.65	42		
<b>T7370-1012</b>	16	5/8			-1012	3.15	80	1.89	48	2.20	56		
<b>T7370-1212</b>	19	3/4			-1212	3.39	86	2.17	55	2.20	56		
<b>T7370-1216</b>	19	3/4			-1216	3.39	86	2.17	55	2.40	61		
<b>T7370-1612</b>	25	1			-1612	4.06	103	2.36	60	2.20	56		
<b>T7370-1616</b>	25	1			-1616	4.37	111	2.68	68	2.76	70		
<b>T7370-1620</b>	25	1			-1620	4.45	113	2.76	70	2.80	71		
<b>T7370-2016</b>	31	1.1/4			-2016	5.00	127	2.95	75	2.76	70		
<b>T7370-2020</b>	31	1.1/4			-2020	5.35	136	3.31	84	3.15	80		
<b>T7370-2024</b>	31	1.1/4			-2024	5.31	135	3.27	83	3.39	86		
<b>T7370-2420</b>	38	1.1/2			-2420	5.51	140	3.31	84	3.15	80		
<b>T7370-2424</b>	38	1.1/2			-2424	6.06	154	3.86	98	3.86	98		
<b>T7370-2432</b>	38	1.1/2			-2432	6.30	160	4.09	104	4.09	104		

### SAE FLANGE

### T7930

SAE CODE 62 FLANGE  
110° TUBE BEND  
O RING NOT SUPPLIED

CLAMPS - SEE PAGES 274 & 282

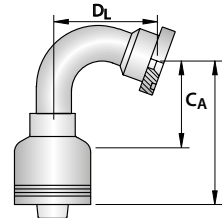

PART NO.	HOSE SIZE		THREAD SIZE	TUBE SIZE	DASH SIZE	DIMENSIONS						SPANNER	
	DN	inch				inch						H <sub>F</sub>	H <sub>M</sub>
						inch	mm	inch	mm	inch	mm		
<b>T7930-2424</b>	38	1.1/2		-	-2424	7.80	198	5.59	142	4.69	119		
<b>T7930-2432</b>	38	1.1/2		-	-2432	8.11	206	5.91	150	4.96	126		
<b>T7930-3232</b>	51	2		-	-3232	7.76	197	5.28	134	6.02	153		

INTRODUCTION

INDEXES

ONE-PIECE  
COUPLINGS

PUSH-ON SUCTION &  
RETURN COUPLINGS

FIELD ATTACHABLE  
COUPLINGS

HYDRAULIC FITTINGS  
ACCESSORIES

# ONE-PIECE COUPLINGS

## T7000 SERIES ONE-PIECE CRIMP COUPLINGS

### SPECIAL FLANGE

### T7333

**RYCO CODE 62C FLANGE**  
O RING NOT SUPPLIED

CLAMPS - SEE PAGES 274 & 282

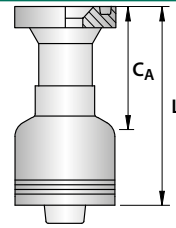

PART NO.	HOSE SIZE		THREAD SIZE	TUBE SIZE	DASH SIZE	DIMENSIONS						SPANNER				
	DN	inch				L		C <sub>A</sub>		D <sub>L</sub>			H <sub>F</sub>	H <sub>M</sub>		
	DN	inch				inch	mm	inch	mm	inch	mm					
T7333-1212	19	3/4			-1212	3.66	93	2.44	62							
T7333-1216	19	3/4			-1216	3.66	93	2.44	62							
T7333-1616	25	1			-1616	4.21	107	2.52	64							
T7333-1620	25	1			-1620	4.53	115	2.83	72							
T7333-2020	31	1.1/4			-2020	5.47	139	3.43	87							
T7333-2024	31	1.1/4			-2024	5.47	139	3.43	87							
T7333-2424	38	1.1/2			-2424	6.18	157	3.98	101							
T7333-3232	51	2			-3232	6.61	168	4.17	106							

### SPECIAL FLANGE

### T7443

**RYCO CODE 62C FLANGE**  
**22.5° TUBE BEND**  
O RING NOT SUPPLIED

CLAMPS - SEE PAGES 274 & 282

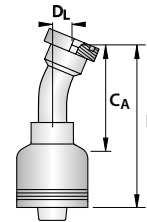

PART NO.	HOSE SIZE		THREAD SIZE	TUBE SIZE	DASH SIZE	DIMENSIONS						SPANNER			
	DN	inch				L		C <sub>A</sub>		D <sub>L</sub>			H <sub>F</sub>	H <sub>M</sub>	
	DN	inch				inch	mm	inch	mm	inch	mm				
T7443-1212	19	3/4			-1212	4.33	110	3.11	79	0.59	15				
T7443-1216	19	3/4			-1216	4.57	116	3.35	85	0.79	20				
T7443-1616	25	1			-1616	5.20	132	3.50	89	0.63	16				
T7443-1620	25	1			-1620	5.35	136	3.66	93	0.63	16				
T7443-2020	31	1.1/4			-2020	6.26	159	4.21	107	0.67	17				
T7443-2024	31	1.1/4			-2024	7.44	189	5.39	137	0.87	22				
T7443-2424	38	1.1/2			-2424	7.17	182	4.96	126	0.94	24				

### SPECIAL FLANGE

### T7444

**RYCO CODE 62C FLANGE**  
**D-RING FLANGE 22.5° TUBE BEND**  
O RING NOT SUPPLIED

CLAMPS - SEE PAGES 274 & 282

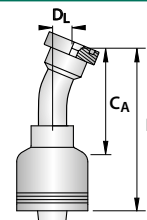

PART NO.	HOSE SIZE		THREAD SIZE	TUBE SIZE	DASH SIZE	DIMENSIONS						SPANNER			
	DN	inch				L		C <sub>A</sub>		D <sub>L</sub>			H <sub>F</sub>	H <sub>M</sub>	
	DN	inch				inch	mm	inch	mm	inch	mm				
T7444-1212	19	3/4			3/4	-1212	4.33	110	3.11	79	0.59				
T7444-1616	25	1			1	-1616	5.20	132	3.50	89	0.63				
T7444-1620	25	1			1.1/4	-1620	5.35	136	3.66	93	0.63				
T7444-2020	31	1.1/4			1.1/4	-2020	6.26	159	4.21	107	0.67				

## T7000 SERIES ONE-PIECE CRIMP COUPLINGS

### SPECIAL FLANGE

### T7453

RYCO CODE 62C FLANGE  
30° TUBE BEND  
O RING NOT SUPPLIED

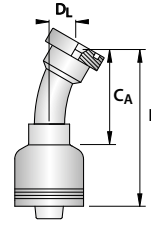

PART NO.	HOSE SIZE		THREAD SIZE	TUBE SIZE	DASH SIZE	DIMENSIONS						SPANNER	
	DN	inch				L		C <sub>A</sub>		D <sub>L</sub>		H <sub>F</sub>	H <sub>M</sub>
	DN	inch				inch	mm	inch	mm	inch	mm		
<b>T7453-1212</b>	19	3/4			-1212	4.45	113	3.23	82	0.91	23		
<b>T7453-1616</b>	25	1			-1616	5.94	151	4.25	108	0.94	24		
<b>T7453-1620</b>	25	1			-1620	6.06	154	4.37	111	0.98	25		
<b>T7453-2020</b>	31	1.1/4			-2020	6.57	167	4.53	115	0.98	25		
<b>T7453-2024</b>	31	1.1/4			-2024	6.54	166	4.49	114	1.02	26		
<b>T7453-2424</b>	38	1.1/2			-2424	7.20	183	5.00	127	1.18	30		

### SPECIAL FLANGE

### T7454

RYCO CODE 62C D-RING FLANGE  
30° TUBE BEND  
O RING NOT SUPPLIED

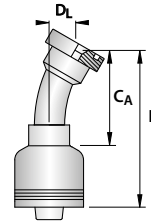

PART NO.	HOSE SIZE		THREAD SIZE	TUBE SIZE	DASH SIZE	DIMENSIONS						SPANNER	
	DN	inch				L		C <sub>A</sub>		D <sub>L</sub>		H <sub>F</sub>	H <sub>M</sub>
	DN	inch				inch	mm	inch	mm	inch	mm		
<b>T7454-1212</b>	19	3/4			-1212	4.45	113	3.23	82	0.91	23		
<b>T7454-1616</b>	25	1			-1616	5.16	131	3.46	88	0.94	24		
<b>T7454-2020</b>	31	1.1/4			-2020	6.57	167	4.53	115	0.98	25		
<b>T7454-2024</b>	31	1.1/4			-2024	6.57	167	4.53	115	1.02	26		

INTRODUCTION

INDEXES

ONE-PIECE  
COUPLINGS

PUSH-ON SUCTION &  
RETURN COUPLINGS

FIELD ATTACHABLE  
COUPLINGS

HYDRAULIC FITTINGS  
ACCESSORIES

# ONE-PIECE COUPLINGS

## T7000 SERIES ONE-PIECE CRIMP COUPLINGS

### SPECIAL FLANGE

### T7353

RYCO CODE 62C FLANGE  
45° TUBE BEND  
O RING NOT SUPPLIED

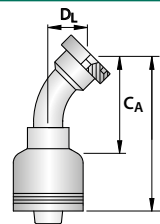

PART NO.	HOSE SIZE		THREAD SIZE	TUBE SIZE	DASH SIZE	DIMENSIONS						SPANNER	
	DN	inch				L		C <sub>A</sub>		D <sub>L</sub>		H <sub>F</sub>	H <sub>M</sub>
						inch	mm	inch	mm	inch	mm		
T7353-1212	19	3/4			-1212	3.94	100	2.72	69	1.22	31		
T7353-1216	19	3/4			-1216	4.06	103	2.83	72	1.30	33		
T7353-1616	25	1			-1616	5.24	133	3.54	90	1.38	35		
T7353-1620	25	1			-1620	5.12	130	3.43	87	1.46	37		
T7353-2020	31	1.1/4			-2020	6.14	156	4.09	104	1.61	41		
T7353-2024	31	1.1/4			-2024	6.30	160	4.25	108	1.69	43		
T7353-2424	38	1.1/2			-2424	6.73	171	4.53	115	1.81	46		
T7353-3232	51	2			-3232	8.62	219	6.14	156	2.40	61		

### SPECIAL FLANGE

### T7354

RYCO CODE 62C D-RING FLANGE  
45° TUBE BEND  
O RING NOT SUPPLIED

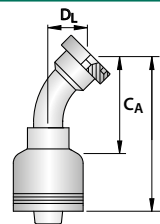

PART NO.	HOSE SIZE		THREAD SIZE	TUBE SIZE	DASH SIZE	DIMENSIONS						SPANNER	
	DN	inch				L		C <sub>A</sub>		D <sub>L</sub>		H <sub>F</sub>	H <sub>M</sub>
						inch	mm	inch	mm	inch	mm		
T7354-1212	19	3/4			-1212	3.94	100	2.72	69	1.22	31		
T7354-1216	19	3/4			-1216	2.44	62	1.22	31	1.30	33		
T7354-1616	25	1			-1616	5.24	133	3.54	90	1.38	35		
T7354-1620	25	1			-1620	4.92	125	3.23	82	1.46	37		
T7354-2020	31	1.1/4			-2020	6.14	156	4.09	104	1.61	41		
T7354-2024	31	1.1/4			-2024	6.14	156	4.09	104	1.69	43		

## T7000 SERIES ONE-PIECE CRIMP COUPLINGS

### SPECIAL FLANGE

### T7463

RYCO CODE 62C FLANGE  
60° TUBE BEND  
O RING NOT SUPPLIED

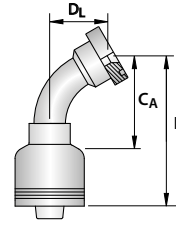

PART NO.	HOSE SIZE		THREAD SIZE	TUBE SIZE	DASH SIZE	DIMENSIONS						SPANNER	
	DN	inch				L		C <sub>A</sub>		D <sub>L</sub>		H <sub>F</sub>	H <sub>M</sub>
						inch	mm	inch	mm	inch	mm		
<b>T7463-1212</b>	19	3/4			-1212	4.45	113	3.23	82	1.65	42		
<b>T7463-1216</b>	19	3/4			-1216	4.49	114	3.27	83	1.85	47		
<b>T7463-1616</b>	25	1			-1616	5.47	139	3.78	96	1.85	47		
<b>T7463-1620</b>	25	1			-1620	5.71	145	4.02	102	1.93	49		
<b>T7463-2020</b>	31	1.1/4			-2020	6.77	172	4.72	120	2.20	56		
<b>T7463-2024</b>	31	1.1/4			-2024	6.57	167	4.53	115	2.60	66		
<b>T7463-2424</b>	38	1.1/2			-2424	7.87	200	5.67	144	2.68	68		

### SPECIAL FLANGE

### T7464

RYCO CODE 62C D-RING FLANGE  
60° TUBE BEND  
O RING NOT SUPPLIED

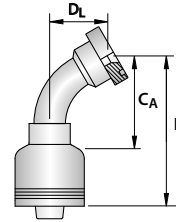

PART NO.	HOSE SIZE		THREAD SIZE	TUBE SIZE	DASH SIZE	DIMENSIONS						SPANNER	
	DN	inch				L		C <sub>A</sub>		D <sub>L</sub>		H <sub>F</sub>	H <sub>M</sub>
						inch	mm	inch	mm	inch	mm		
<b>T7464-1212</b>	19	3/4			-1212	4.45	113	3.23	82	1.65	42		
<b>T7464-1216</b>	19	3/4			-1216	2.44	62	1.22	31	1.65	42		
<b>T7464-1616</b>	25	1			-1616	5.47	139	3.78	96	1.85	47		
<b>T7464-1620</b>	25	1			-1620	5.67	144	3.98	101	1.93	49		
<b>T7464-2020</b>	31	1.1/4			-2020	6.77	172	4.72	120	2.20	56		
<b>T7464-2024</b>	31	1.1/4			-2024	6.61	168	4.57	116	2.60	66		

INTRODUCTION

INDEXES

ONE-PIECE COUPLINGS

PUSH-ON SUCTION & RETURN COUPLINGS

FIELD ATTACHABLE COUPLINGS

HYDRAULIC FITTINGS ACCESSORIES

# ONE-PIECE COUPLINGS

## T7000 SERIES ONE-PIECE CRIMP COUPLINGS

### SPECIAL FLANGE

### T7363

RYCO CODE 62C FLANGE  
67.5° TUBE BEND  
O RING NOT SUPPLIED

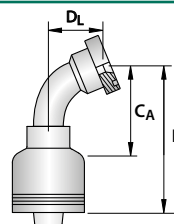

PART NO.	HOSE SIZE		THREAD SIZE	TUBE SIZE	DASH SIZE	DIMENSIONS						SPANNER	
	DN	inch				L		C <sub>A</sub>		D <sub>L</sub>		H <sub>F</sub>	H <sub>M</sub>
						inch	mm	inch	mm	inch	mm		
T7363-1212	19	3/4			-1212	4.17	106	2.95	75	2.05	52		
T7363-1216	19	3/4			-1216	4.33	110	3.11	79	2.09	53		
T7363-1616	25	1			-1616	5.28	134	3.58	91	2.09	53		
T7363-1620	25	1			-1620	5.31	135	3.62	92	2.20	56		
T7363-2020	31	1.1/4			-2020	6.50	165	4.45	113	2.64	67		
T7363-2024	31	1.1/4			-2024	7.40	188	5.35	136	2.99	76		
T7363-2424	38	1.1/2			-2424	7.56	192	5.35	136	3.03	77		

### SPECIAL FLANGE

### T7364

RYCO CODE 62C D-RING FLANGE  
67.5° TUBE BEND  
O RING NOT SUPPLIED

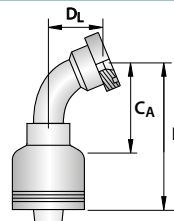

PART NO.	HOSE SIZE		THREAD SIZE	TUBE SIZE	DASH SIZE	DIMENSIONS						SPANNER	
	DN	inch				L		C <sub>A</sub>		D <sub>L</sub>		H <sub>F</sub>	H <sub>M</sub>
						inch	mm	inch	mm	inch	mm		
T7364-1212	19	3/4			-1212	4.33	110	3.11	79	2.05	52		
T7364-1216	19	3/4			-1216	2.44	62	1.22	31	2.09	53		
T7364-1616	25	1			-1616	5.28	134	3.58	91	2.09	53		
T7364-1620	25	1			-1620	5.31	135	3.62	92	2.20	56		
T7364-2020	31	1.1/4			-2020	6.50	165	4.45	113	2.64	67		
T7364-2024	31	1.1/4			-2024	6.22	158	4.17	106	2.99	76		

## T7000 SERIES ONE-PIECE CRIMP COUPLINGS

### SPECIAL FLANGE

### T7373

RYCO CODE 62C FLANGE  
90° TUBE BEND  
O RING NOT SUPPLIED

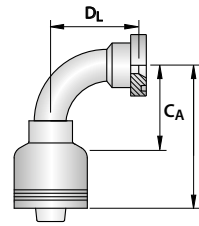

PART NO.	HOSE SIZE		THREAD SIZE	TUBE SIZE	DASH SIZE	DIMENSIONS						SPANNER	
	DN	inch				L		C <sub>A</sub>		D <sub>L</sub>		H <sub>F</sub>	H <sub>M</sub>
						inch	mm	inch	mm	inch	mm		
<b>T7373-1212</b>	19	3/4			-1212	3.39	86	2.17	55	2.44	62		
<b>T7373-1216</b>	19	3/4			-1216	3.39	86	2.17	55	2.60	66		
<b>T7373-1616</b>	25	1			-1616	4.37	111	2.68	68	2.83	72		
<b>T7373-1620</b>	25	1			-1620	4.37	111	2.68	68	2.95	75		
<b>T7373-2020</b>	31	1.1/4			-2020	5.39	137	3.35	85	3.27	83		
<b>T7373-2024</b>	31	1.1/4			-2024	5.43	138	3.39	86	3.35	85		
<b>T7373-2424</b>	38	1.1/2			-2424	6.06	154	3.86	98	3.78	96		
<b>T7373-3232</b>	51	2			-3232	7.87	200	5.39	137	5.24	133		

### SPECIAL FLANGE

### T7378

RYCO CODE 62C FLANGE  
90° TUBE BEND  
O RING NOT SUPPLIED

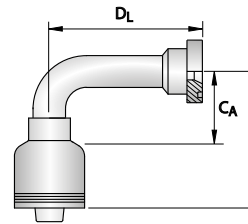

PART NO.	HOSE SIZE		THREAD SIZE	TUBE SIZE	DASH SIZE	DIMENSIONS						SPANNER	
	DN	inch				L		C <sub>A</sub>		D <sub>L</sub>		H <sub>F</sub>	H <sub>M</sub>
						inch	mm	inch	mm	inch	mm		
<b>T7378-2020</b>	31	1.1/4			-2020	5.39	137	3.35	85	5.91	150		
<b>T7378-2024</b>	31	1.1/4			-2024	5.43	138	3.39	86	5.31	135		

### SPECIAL FLANGE

### T7374

RYCO CODE 62C D-RING FLANGE  
110° TUBE BEND  
O RING NOT SUPPLIED

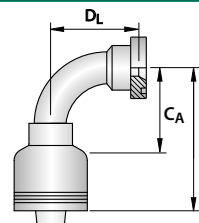

PART NO.	HOSE SIZE		THREAD SIZE	TUBE SIZE	DASH SIZE	DIMENSIONS						SPANNER	
	DN	inch				L		C <sub>A</sub>		D <sub>L</sub>		H <sub>F</sub>	H <sub>M</sub>
						inch	mm	inch	mm	inch	mm		
<b>T7374-1212</b>	19	3/4			-1212	3.39	86	2.17	55	2.44	62		
<b>T7374-1216</b>	19	3/4			-1216	3.39	86	2.17	55	2.60	66		
<b>T7374-1616</b>	25	1			-1616	4.37	111	2.68	68	2.83	72		
<b>T7374-1620</b>	25	1			-1620	4.49	114	2.80	71	2.95	75		
<b>T7374-2020</b>	31	1.1/4			-2020	5.39	137	3.35	85	3.27	83		
<b>T7374-2024</b>	31	1.1/4			-2024	5.43	138	3.39	86	3.35	85		

# ONE-PIECE COUPLINGS

## T7000 SERIES ONE-PIECE CRIMP COUPLINGS

### STANDPIPE

### T7933

RYCO CODE 62C FLANGE  
110° TUBE BEND

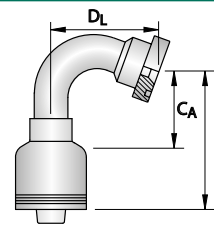

PART NO.	HOSE SIZE		THREAD SIZE	TUBE SIZE	DASH SIZE	DIMENSIONS						SPANNER			
	DN	inch				L		C <sub>A</sub>		D <sub>L</sub>		H <sub>F</sub>		H <sub>M</sub>	
						inch	mm	inch	mm	inch	mm	inch	mm		
<b>T7933-2424</b>	38	1.1/2			1.1/2	-2424	7.76	197	5.55	141	4.72	120			

### STANDPIPE

### T7640

METRIC STANDPIPE

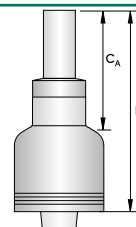

PART NO.	HOSE SIZE		THREAD SIZE	TUBE SIZE	DASH SIZE	DIMENSIONS						SPANNER			
	DN	inch				L		C <sub>A</sub>		D <sub>L</sub>		H <sub>F</sub>		H <sub>M</sub>	
				inch		inch	mm	inch	mm						
<b>T7640-0814</b>	12	1/2		14	-0814	2.60	66	1.54	39						
<b>T7640-1220</b>	19	3/4		20	-1220	3.03	77	1.81	46						
<b>T7640-2030</b>	31	1.1/4		30	-2030	4.37	111	2.32	59						

### SALVAGE / LIFESAVER

### T7230

SALVAGE (LIFESAVER)

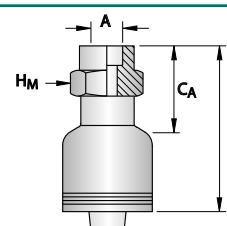

PART NO.	HOSE SIZE		THREAD SIZE	TUBE SIZE	DASH SIZE	DIMENSIONS						SPANNER			
	DN	inch				L		C <sub>A</sub>		D <sub>L</sub>		H <sub>F</sub>		H <sub>M</sub>	
				inch		inch	mm	inch	mm			inch	mm		
<b>T7230-0808</b>	12	1/2		1/2	-0808	1.81	46	0.75	19					11/16	
<b>T7230-0810</b>	12	1/2		5/8	-0810	1.89	48	0.83	21					7/8	22
<b>T7230-1210</b>	19	3/4		5/8	-1210	2.24	57	1.02	26					1.1/8	
<b>T7230-1212</b>	19	3/4		3/4	-1212	2.05	52	0.83	21					1	
<b>T7230-1216</b>	19	3/4		1	-1216	2.28	58	1.10	28					1.3/8	35
<b>T7230-1612</b>	25	1		3/4	-1612	2.72	69	1.02	26					1.3/8	35
<b>T7230-1616</b>	25	1		1	-1616	2.80	71	1.10	28					1.3/8	35
<b>T7230-1620</b>	25	1		1.1/4	-1620	2.83	72	1.14	29					1.3/4	
<b>T7230-2016</b>	31	1.1/4		1	-2016	3.27	83	1.22	31					1.3/4	
<b>T7230-2020</b>	31	1.1/4		1.1/4	-2020	3.27	83	1.22	31					1.3/4	
<b>T7230-2424</b>	38	1.1/2		1.1/2	-2424	3.54	90	1.34	34					2	50
<b>T7230-3232</b>	51	2		2	-3232	4.09	104	1.61	41					2.1/2	

## T7000 SERIES ONE-PIECE CRIMP COUPLINGS

### UNO (O RING BOSS)

### T7200

UN O RING MALE  
O RING SUPPLIED

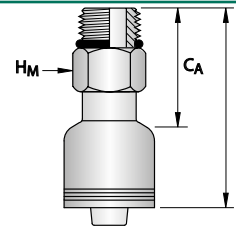

PART NO.	HOSE SIZE		THREAD SIZE	TUBE SIZE	DASH SIZE	DIMENSIONS					SPANNER		
	DN	inch	inch			L		C <sub>A</sub>		D <sub>L</sub>	H <sub>F</sub>	H <sub>M</sub>	
						inch	mm	inch	mm			inch	mm
<b>T7200-1217</b>	19	3/4	1.1/16" -12		-1217	2.68	68	1.46	37			1.1/4	32
<b>T7200-1621</b>	25	1	1.5/16" -12		-1621	3.23	82	1.54	39			1.1/2	38

### HAMMER UNION

### T71501

FIGURE 1502 MALE

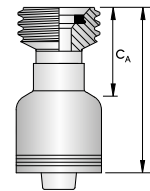

PART NO.	HOSE SIZE		THREAD SIZE	TUBE SIZE	DASH SIZE	DIMENSIONS					SPANNER		
	DN	inch	inch			L		C <sub>A</sub>		D <sub>L</sub>	H <sub>F</sub>	H <sub>M</sub>	
						inch	mm	inch	mm	inch			
<b>T71501-2432</b>	38	1.1/2	4.1/8		2	-2432	5.83	148	3.58	91			
<b>T71501-3232</b>	51	2	4.1/8		2	-3232	6.06	154	3.62	92			

### HAMMER UNION

### T71502

FIGURE 1502 (WITH NUT)

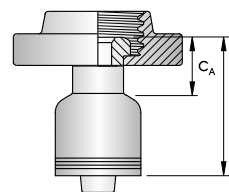

PART NO.	HOSE SIZE		THREAD SIZE	TUBE SIZE	DASH SIZE	DIMENSIONS					SPANNER		
	DN	inch	inch			L		C <sub>A</sub>		D <sub>L</sub>	H <sub>F</sub>	H <sub>M</sub>	
						inch	mm	inch	mm	inch			
<b>T71502-2432</b>	38	1.1/2	4.1/8		2	-2432	6.57	167	4.33	110			
<b>T71502-3232</b>	51	2	4.1/8		2	-3232	6.81	173	4.37	111			

INTRODUCTION

INDEXES

ONE-PIECE  
COUPLINGS

PUSH-ON SUCTION &  
RETURN COUPLINGS

FIELD ATTACHABLE  
COUPLINGS

HYDRAULIC FITTINGS  
ACCESSORIES

# ONE-PIECE COUPLINGS

## TP000 SERIES ONE-PIECE CRIMP COUPLINGS

### HOSE COMPATIBILITY FOR TP000 SERIES

#### NON-SKIVE

For Ryco Hose Series TP7, TP7N, TP7T, TP7TN, TP8, TP8N, TP8T, TP8TN, TP3000 (all sizes).

### BSPT

### TP010

BSPT MALE  
60° SEAT

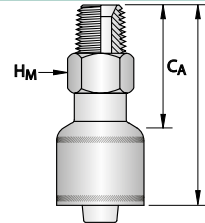

PART NO.	HOSE SIZE		THREAD SIZE	TUBE SIZE	DASH SIZE	DIMENSIONS				SPANNER					
	DN	inch	inch			L		C <sub>A</sub>		D <sub>L</sub>		H <sub>F</sub>		H <sub>M</sub>	
						inch	mm	inch	mm			inch	mm	inch	mm
TP010-0404	6	1/4	1/4" -19		-0404	2.32	59	1.30	33					9/16	
TP010-0406	6	1/4	3/8" -19		-0406	2.28	58	1.22	31					11/16	
TP010-0506	8	5/16	3/8" -19		-0506	2.09	53	1.22	31					11/16	
TP010-0604	10	3/8	1/4" -19		-0604	2.44	62	1.38	35					5/8	16
TP010-0606	10	3/8	3/8" -19		-0606	2.44	62	1.38	35					11/16	
TP010-0608	10	3/8	1/2" -14		-0608	2.64	67	1.57	40					7/8	22
TP010-0806	12	1/2	3/8" -19		-0806	2.64	67	1.42	36					11/16	
TP010-0808	12	1/2	1/2" -14		-0808	2.83	72	1.61	41					7/8	22
TP010-1212	19	3/4	3/4" -14		-1212	3.03	77	1.69	43					1.1/16	27
TP010-1616	25	1	1" -11		-1616	3.39	86	1.93	49					1.3/8	35

### BSPP

### TP020

BSPP FEMALE  
60° CONE

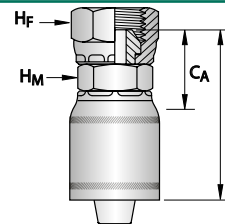

PART NO.	HOSE SIZE		THREAD SIZE	TUBE SIZE	DASH SIZE	DIMENSIONS				SPANNER					
	DN	inch	inch			L		C <sub>A</sub>		D <sub>L</sub>		H <sub>F</sub>		H <sub>M</sub>	
						inch	mm	inch	mm			inch	mm	inch	mm
TP020-0304	5	3/16	1/4" -19		-0304	2.05	52	1.02	26			3/4	19	1/2	
TP020-0402	6	1/4	1/8" -28		-0402	2.09	53	1.02	26				14	1/2	
TP020-0404	6	1/4	1/4" -19		-0404	2.09	53	1.06	27			3/4	19	1/2	
TP020-0406	6	1/4	3/8" -19		-0406	2.20	56	1.14	29			7/8	22	5/8	16
TP020-0504	8	5/16	1/4" -19		-0504	2.01	51	0.94	24			3/4	19	9/16	14
TP020-0506	8	5/16	3/8" -19		-0506	2.20	56	1.14	29			7/8	22	5/8	16
TP020-0604	10	3/8	1/4" -19		-0604	2.05	52	0.94	24			3/4	19	9/16	14
TP020-0606	10	3/8	3/8" -19		-0606	2.24	57	1.14	29			7/8	22	5/8	16
TP020-0608	10	3/8	1/2" -14		-0608	2.28	58	1.22	31			1.1/16	27	3/4	19
TP020-0808	12	1/2	1/2" -14		-0808	2.32	59	1.10	28			1.1/16	27	3/4	19
TP020-0810	12	1/2	5/8" -14		-0810	2.36	60	1.14	29			1.3/16	30	7/8	22
TP020-0812	12	1/2	3/4" -14		-0812	2.44	62	1.22	31			1.1/4	32	1	0
TP020-1212	19	3/4	3/4" -14		-1212	2.60	66	1.18	30			1.1/4	32	1	
TP020-1616	25	1	1" -11		-1616	2.99	76	1.50	38			1.1/2	38	1.1/4	32

## TP000 SERIES ONE-PIECE CRIMP COUPLINGS

### BSPP

### TP050

BSPP FEMALE  
60° CONE  
90° ELBOW

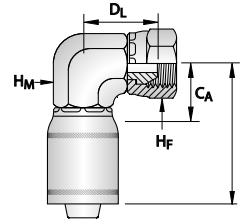

PART NO.	HOSE SIZE		THREAD SIZE	TUBE SIZE	DASH SIZE	DIMENSIONS						SPANNER			
	DN	inch	inch			L		C <sub>A</sub>		D <sub>L</sub>		H <sub>F</sub>		H <sub>M</sub>	
	DN	inch	inch			inch	mm	inch	mm	inch	mm	inch	mm	inch	mm
TP050-0404	6	1/4	1/4" -19		-0404	1.93	49	0.87	22	0.94	24	3/4	19	9/16	
TP050-0606	10	3/8	3/8" -19		-0606	1.97	50	0.91	23	1.10	28	7/8	22	3/4	19
TP050-0808	12	1/2	1/2" -14		-0808	2.32	59	1.14	29	1.22	31	1.1/16	27	7/8	22

### JIS

### TP122

BSPP FEMALE  
60° CONCAVE SEAT (JIS)

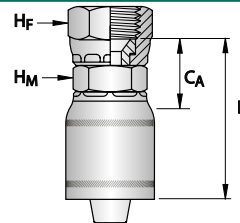

PART NO.	HOSE SIZE		THREAD SIZE	TUBE SIZE	DASH SIZE	DIMENSIONS						SPANNER			
	DN	inch	inch			L		C <sub>A</sub>		D <sub>L</sub>		H <sub>F</sub>		H <sub>M</sub>	
	DN	inch	inch			inch	mm	inch	mm			inch	mm	inch	mm
TP122-0404	6	1/4	1/4" -19		-0404	2.01	51	0.94	24			3/4	19		14
TP122-0606	10	3/8	3/8" -19		-0606	2.17	55	1.06	27			7/8	22		17
TP122-0608	10	3/8	1/2" -14		-0608	2.20	56	1.14	29			1.1/16	27	7/8	22
TP122-0808	12	1/2	1/2" -14		-0808	2.32	59	1.14	29			1.1/16	27	7/8	22
TP122-1212	19	3/4	3/4" -14		-1212	2.44	62	1.10	28				36	1.1/16	27

### BSPP

### TP260

BSPP FEMALE  
60° CONE  
90° TUBE BEND

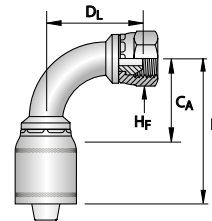

PART NO.	HOSE SIZE		THREAD SIZE	TUBE SIZE	DASH SIZE	DIMENSIONS						SPANNER			
	DN	inch	inch			L		C <sub>A</sub>		D <sub>L</sub>		H <sub>F</sub>		H <sub>M</sub>	
	DN	inch	inch			inch	mm	inch	mm	inch	mm	inch	mm		
TP260-0404	6	1/4	1/4" -19		-0404	2.13	54	1.10	28	1.14	29	3/4	19		
TP260-0406	6	1/4	3/8" -19		-0406	2.13	54	1.10	28	1.10	28	7/8	22		
TP260-0606	10	3/8	3/8" -19		-0606	2.44	62	1.38	35	1.30	33	7/8	22		
TP260-0608	10	3/8	1/2" -14		-0608	2.44	62	1.38	35	1.30	33	1.1/16	27		
TP260-0808	12	1/2	1/2" -14		-0808	2.68	68	1.50	38	1.77	45	1.1/16	27		
TP260-0810	12	1/2	5/8" -14		-0810	2.76	70	1.57	40	1.77	45	1.3/16	30		
TP260-1212	19	3/4	3/4" -14		-1212	3.58	91	2.17	55	2.32	59	1.1/4	32		
TP260-1616	25	1	1" -11		-1616	4.09	104	2.68	68	3.07	78	1.1/2	38		

# ONE-PIECE COUPLINGS

## TP000 SERIES ONE-PIECE CRIMP COUPLINGS

**BSPP**

**TP270**

BSPP FEMALE  
60° CONE  
1/45° TUBE BEND

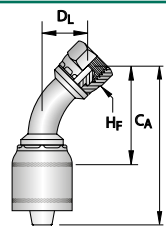

PART NO.	HOSE SIZE		THREAD SIZE	TUBE SIZE	DASH SIZE	DIMENSIONS						SPANNER			
	DN	inch	inch			L		C <sub>A</sub>		D <sub>L</sub>		H <sub>F</sub>		H <sub>M</sub>	
	DN	inch	inch			inch	mm	inch	mm	inch	mm	inch	mm	inch	mm
TP270-0404	6	1/4	1/4" -19		-0404	2.44	62	1.42	36	0.67	17	3/4	19		
TP270-0606	10	3/8	3/8" -19		-0606	2.80	71	1.73	44	0.71	18	7/8	22		
TP270-0808	12	1/2	1/2" -14		-0808	3.15	80	1.97	50	0.87	22	1.1/16	27		
TP270-1212	19	3/4	3/4" -14		-1212	4.17	106	2.76	70	1.14	29	1.1/4	32		
TP270-1616	25	1	1" -11		-1616	4.76	121	3.35	85	1.65	42	1.1/2	38		

**BSP - BANJO**

**TP475**

BSP BANJO STRAIGHT

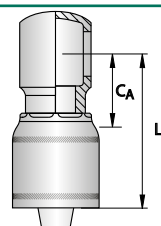

PART NO.	HOSE SIZE		THREAD SIZE	TUBE SIZE	DASH SIZE	DIMENSIONS						SPANNER			
	DN	inch	inch			L		C <sub>A</sub>		D <sub>L</sub>		H <sub>F</sub>		H <sub>M</sub>	
	DN	inch	inch			inch	mm	inch	mm	inch	mm	inch	mm	inch	mm
TP475-0404	6	1/4	1/4		-0404	2.05	52	0.98	25						
TP475-0506	8	5/16	3/8		-0506	2.12	54	1.07	27						
TP475-0606	10	3/8	3/8		-0606	2.17	55	1.06	27						
TP475-0608	10	3/8	1/2		-0608	2.20	56	1.10	28						
TP475-0808	12	1/2	1/2		-0808	2.32	59	1.10	28						
TP475-1212	19	3/4	3/4		-1212	2.67	68	1.23	31						
TP475-1616	25	1	1		-1616	3.23	82	1.75	45						

## TP000 SERIES ONE-PIECE CRIMP COUPLINGS

**NPTF**

**TP090**

NPTF MALE  
60° SEAT

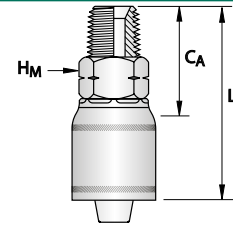

PART NO.	HOSE SIZE		THREAD SIZE	TUBE SIZE	DASH SIZE	DIMENSIONS						SPANNER			
	DN	inch	inch			L		C <sub>A</sub>		D <sub>L</sub>		H <sub>F</sub>		H <sub>M</sub>	
						inch	mm	inch	mm			inch	mm	inch	mm
TP090-0302	5	3/16	1/8" -27		-0302	2.13	54	1.10	28					1/2	
TP090-0304	5	3/16	1/4" -18		-0304	2.28	58	1.26	32					9/16	
TP090-0402	6	1/4	1/8" -27		-0402	2.17	55	1.10	28					1/2	
TP090-0404	6	1/4	1/4" -18		-0404	2.32	59	1.30	33					9/16	
TP090-0406	6	1/4	3/8" -18		-0406	2.32	59	1.30	33					11/16	
TP090-0506	8	5/16	3/8" -18		-0506	2.36	60	1.30	33					11/16	
TP090-0604	10	3/8	1/4" -18		-0604	2.44	62	1.38	35					5/8	16
TP090-0606	10	3/8	3/8" -18		-0606	2.44	62	1.38	35					11/16	
TP090-0608	10	3/8	1/2" -14		-0608	2.64	67	1.57	40					7/8	22
TP090-0806	12	1/2	3/8" -18		-0806	2.64	67	1.42	36					11/16	
TP090-0808	12	1/2	1/2" -14		-0808	2.83	72	1.61	41					7/8	22
TP090-1212	19	3/4	3/4" -14		-1212	3.03	77	1.69	43					1.1/16	27
TP090-1616	25	1	1" -11.5		-1616	3.39	86	1.93	49					1.3/8	35

**NPTF**

**TP340N**

NPTF MALE SWIVEL  
90° ELBOW  
60° SEAT

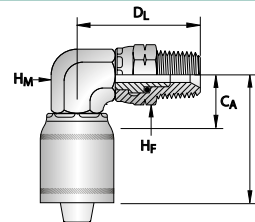

PART NO.	HOSE SIZE		THREAD SIZE	TUBE SIZE	DASH SIZE	DIMENSIONS						SPANNER			
	DN	inch	inch			L		C <sub>A</sub>		D <sub>L</sub>		H <sub>F</sub>		H <sub>M</sub>	
						inch	mm	inch	mm	inch	mm	inch	mm	inch	mm
TP340N-0304	5	3/16	1/4" -18		-0304	1.85	47	0.87	22	1.61	41	11/16		9/16	
TP340N-0404	6	1/4	1/4" -18		-0404	1.93	49	0.87	22	1.61	41	11/16		9/16	
TP340N-0506	8	5/16	3/8" -18		-0506	1.97	50	0.91	23	1.77	45	7/8	22	3/4	19
TP340N-0606	10	3/8	3/8" -18		-0606	1.97	50	0.91	23	1.77	45	7/8	22	3/4	19
TP340N-0808	12	1/2	1/2" -14		-0808	2.32	59	1.14	29	2.01	51	1		7/8	22

# ONE-PIECE COUPLINGS

## TP000 SERIES ONE-PIECE CRIMP COUPLINGS

### NPSM

### TP020N

NPSM FEMALE  
60° CONE

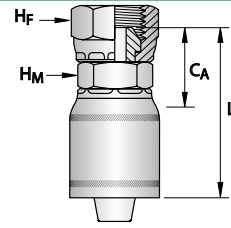

PART NO.	HOSE SIZE		THREAD SIZE	TUBE SIZE	DASH SIZE	DIMENSIONS						SPANNER			
	DN	inch	inch			L		C <sub>A</sub>		D <sub>L</sub>		H <sub>F</sub>		H <sub>M</sub>	
						inch	mm	inch	mm			inch		inch	
TP020N-0404	6	1/4	1/4" -18		-0404	2.01	51	0.94	24			11/16		1/2	

### JIC

### TP030

JIC  
37° CONE MALE

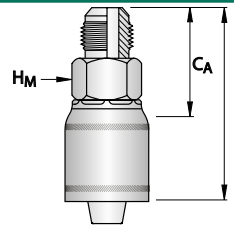

PART NO.	HOSE SIZE		THREAD SIZE	TUBE SIZE	DASH SIZE	DIMENSIONS						SPANNER			
	DN	inch	inch			L		C <sub>A</sub>		D <sub>L</sub>		H <sub>F</sub>		H <sub>M</sub>	
						inch	mm	inch	mm			inch		inch	mm
TP030-0307	5	3/16	7/16" -20		-0307	2.28	58	1.26	32					1/2	
TP030-0407	6	1/4	7/16" -20		-0407	2.32	59	1.26	32					1/2	
TP030-0408	6	1/4	1/2" - 20		-0408	2.32	59	1.26	32					9/16	
TP030-0409	6	1/4	9/16" -18		-0409	2.28	58	1.22	31					5/8	16
TP030-0508	8	5/16	1/2" - 20		-0508	2.32	59	1.26	32					9/16	14
TP030-0509	8	5/16	9/16" -18		-0509	2.32	59	1.26	32					5/8	16
TP030-0609	10	3/8	9/16" -18		-0609	2.44	62	1.38	35					5/8	16
TP030-0612	10	3/8	3/4" -16		-0612	2.52	64	1.46	37					3/4	19
TP030-0812	12	1/2	3/4" -16		-0812	2.72	69	1.54	39					3/4	19
TP030-0814	12	1/2	7/8" -14		-0814	2.83	72	1.61	41					15/16	24
TP030-1217	19	3/4	1.1/16" -12		-1217	3.11	79	1.77	45					1.1/8	
TP030-1621	25	1	1.5/16" -12		-1621	3.35	85	1.89	48					1.3/8	35

### JIC

### TP031

JIC MALE

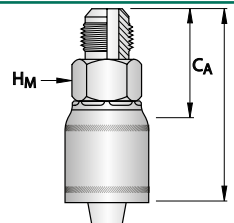

PART NO.	HOSE SIZE		THREAD SIZE	TUBE SIZE	DASH SIZE	DIMENSIONS						SPANNER			
	DN	inch	inch			L		C <sub>A</sub>		D <sub>L</sub>		H <sub>F</sub>		H <sub>M</sub>	
						inch	mm	inch	mm	inch	mm	inch	mm	inch	mm
TP031-0307	5	3/16	7/16" -20		-0307										
TP031-0407	6	1/4	7/16" -20		-0407										
TP031-0408	6	1/4	1/2" - 20		-0408										
TP031-1621	25	1	1.5/16" -12		-1621										

## TP000 SERIES ONE-PIECE CRIMP COUPLINGS

**JSEAL™ / JIC**

**TP040**

JIC 37°  
CONE MALE

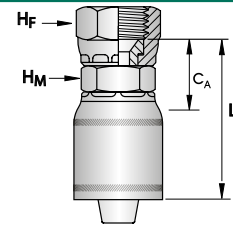

PART NO.	HOSE SIZE		THREAD SIZE	TUBE SIZE	DASH SIZE	DIMENSIONS				SPANNER					
	DN	inch	inch			L		Ca		D <sub>L</sub>		H <sub>F</sub>		H <sub>M</sub>	
						inch	mm	inch	mm			inch	mm	inch	mm
TP040-0307	5	3/16	7/16" -20		-0307	1.97	50	0.94	24			9/16		1/2	
TP040-0308	5	3/16	1/2" - 20		-0308	1.97	50	0.94	24			5/8	16	1/2	
TP040-0407	6	1/4	7/16" -20		-0407	2.01	51	0.98	25			9/16		1/2	
TP040-0408	6	1/4	1/2" - 20		-0408	2.01	51	0.98	25			5/8	16	1/2	
TP040-0409	6	1/4	9/16" -18		-0409	2.05	52	0.98	25			11/16		9/16	
TP040-0509	8	5/16	9/16" -18		-0509	2.05	52	0.98	25			11/16		9/16	
TP040-0607	10	3/8	7/16" -20		-0607	1.95	50	0.88	22						
TP040-0609	10	3/8	9/16" -18		-0609	2.05	52	0.98	25			11/16		9/16	
TP040-0612	10	3/8	3/4" -16		-0612	2.13	54	1.06	27			7/8	22	11/16	
TP040-0809	12	1/2	9/16" -18		-0809	2.13	54	0.91	23			11/16		11/16	
TP040-0812	12	1/2	3/4" -16		-0812	2.17	55	0.94	24			7/8	22	11/16	
TP040-0814	12	1/2	7/8" -14		-0814	2.44	62	1.22	31			1		13/16	
TP040-1214	19	3/4	7/8" -14		-1214	2.72	69	1.38	35			1		1	
TP040-1217	19	3/4	1.1/16" -12		-1217	2.72	69	1.30	33			1.1/4	32	1	
TP040-1621	25	1	1.5/16" -12		-1621	2.99	76	1.50	38			1.1/2	38	1.1/4	32

**JSEAL™ / JIC**

**TP041**

JSEAL™ / JIC FEMALE  
CONVEX SEAT  
METRIC NUT ONLY

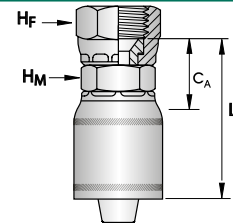

PART NO.	HOSE SIZE		THREAD SIZE	TUBE SIZE	DASH SIZE	DIMENSIONS				SPANNER					
	DN	inch	inch			L		Ca		D <sub>L</sub>		H <sub>F</sub>		H <sub>M</sub>	
						inch	mm	inch	mm			inch	mm		
TP041-0307	5	3/16	7/16" -20		-0307	1.97	50	0.94	24				14		
TP041-0407	6	1/4	7/16" -20		-0407	2.01	51	0.98	25				14		
TP041-0409	6	1/4	9/16" -18		-0409	2.05	52	0.98	25			3/4	19		
TP041-0509	8	5/16	9/16" -18		-0509	2.05	52	0.98	25			3/4	19		
TP041-0607	10	3/8	7/16" -20		-0607	1.95	50	0.87	22				14		
TP041-0609	10	3/8	9/16" -18		-0609	2.05	52	0.98	25			3/4	19		
TP041-0809	12	1/2	9/16" -18		-0809	2.13	54	0.91	23			3/4	19		

# ONE-PIECE COUPLINGS

## TP000 SERIES ONE-PIECE CRIMP COUPLINGS

JSEAL™ / JIC

TP250

JSEAL™ / JIC FEMALE  
CONVEX SEAT  
45° TUBE BEND

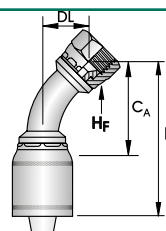

PART NO.	HOSE SIZE		THREAD SIZE	TUBE SIZE	DASH SIZE	DIMENSIONS						SPANNER		
	DN	inch	inch			L		CA		DL		HF		HM
	DN	inch	inch			inch	mm	inch	mm	inch	mm	inch	mm	
TP250-0407	6	1/4	7/16" -20		-0407	2.36	60	1.34	34	0.59	15	9/16		
TP250-0409	6	1/4	9/16" -18		-0409	2.36	60	1.34	34	0.59	15	11/16		
TP250-0609	10	3/8	9/16" -18		-0609	2.56	65	1.50	38	0.55	14	11/16		
TP250-0612	10	3/8	3/4" -16		-0612	2.60	66	1.54	39	0.67	17	7/8	22	
TP250-0812	12	1/2	3/4" -16		-0812	2.99	76	1.81	46	0.83	21	7/8	22	
TP250-0814	12	1/2	7/8" -14		-0814	3.03	77	1.85	47	1.85	47	1		
TP250-1217	19	3/4	1.1/16" -12		-1217	4.21	107	2.80	71	1.10	28	1.1/4	32	

JSEAL™ / JIC

TP251

JSEAL™ / JIC FEMALE  
CONVEX SEAT  
45° TUBE BEND  
METRIC NUT ONLY

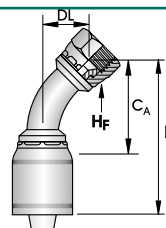

PART NO.	HOSE SIZE		THREAD SIZE	TUBE SIZE	DASH SIZE	DIMENSIONS						SPANNER		
	DN	inch	inch			L		CA		DL		HF		HM
	DN	inch	inch			inch	mm	inch	mm	inch	mm	inch	mm	
TP251-0407	6	1/4	7/16" -20		-0407	2.36	60	1.34	34	0.59	15		14	
TP251-0409	6	1/4	9/16" -18		-0409	2.36	60	1.34	34	0.59	15	3/4	19	
TP251-0609	10	3/8	9/16" -18		-0609	2.56	65	1.50	38	0.55	14	3/4	19	

## TP000 SERIES ONE-PIECE CRIMP COUPLINGS

### JSEAL™ / JIC

### TP240

JSEAL™ / JIC  
FEMALE CONVEX SEAT  
90° TUBE BEND

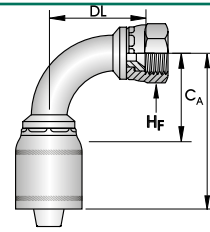

PART NO.	HOSE SIZE		THREAD SIZE	TUBE SIZE	DASH SIZE	DIMENSIONS						SPANNER		
	DN	inch	inch			L		C <sub>A</sub>		D <sub>L</sub>		H <sub>F</sub>		H <sub>M</sub>
						inch	mm	inch	mm	inch	mm	inch	mm	
TP240-0307	5	3/16	7/16" -20		-0307	2.09	53	1.02	26	1.26	32	9/16		
TP240-0407	6	1/4	7/16" -20		-0407	2.09	53	1.02	26	1.26	32	9/16		
TP240-0408	6	1/4	1/2" - 20		-0408	2.09	53	1.02	26	1.26	32	5/8	16	
TP240-0409	6	1/4	9/16" -18		-0409	2.09	53	1.02	26	1.50	38	11/16		
TP240-0509	8	5/16	9/16" -18		-0509	2.09	53	1.02	26	1.50	38	11/16		
TP240-0609	10	3/8	9/16" -18		-0609	2.44	62	1.38	35	0.98	25	11/16		
TP240-0612	10	3/8	3/4" -16		-0612	2.44	62	1.38	35	1.18	30	7/8	22	
TP240-0809	12	1/2	9/16" -18		-0809	2.56	65	1.38	35	0.98	25	11/16		
TP240-0812	12	1/2	3/4" -16		-0812	2.76	70	1.57	40	1.61	41	7/8	22	
TP240-0814	12	1/2	7/8" -14		-0814	2.76	70	1.57	40	1.61	41	1		
TP240-1217	19	3/4	1.1/16" -12		-1217	3.62	92	2.20	56	2.24	57	1.1/4	32	
TP240-1621	25	1	1.5/16" -12		-1621	4.09	104	2.68	68	2.83	72	1.1/2	38	

### JSEAL™ / JIC

### TP241

JSEAL™ / JIC FEMALE  
CONVEX SEAT  
90° TUBE BEND  
METRIC NUT ONLY

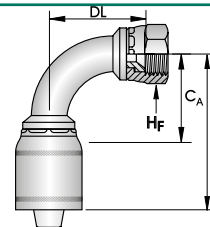

PART NO.	HOSE SIZE		THREAD SIZE	TUBE SIZE	DASH SIZE	DIMENSIONS						SPANNER		
	DN	inch	inch			L		C <sub>A</sub>		D <sub>L</sub>		H <sub>F</sub>		H <sub>M</sub>
						inch	mm	inch	mm	inch	mm	inch	mm	
TP241-0407	6	1/4	7/16" -20		-0407	2.09	53	1.02	26	1.26	32		14	
TP241-0409	6	1/4	9/16" -18		-0409	2.09	53	1.02	26	1.50	38	3/4	19	
TP241-0509	8	5/16	9/16" -18		-0509	2.09	53	1.02	26	1.50	38	3/4	19	
TP241-0609	10	3/8	9/16" -18		-0609	2.44	62	1.38	35	0.98	25	3/4	19	
TP241-0809	12	1/2	9/16" -18		-0809	2.56	65	1.38	35	0.98	25	3/4	19	

# ONE-PIECE COUPLINGS

## TP000 SERIES ONE-PIECE CRIMP COUPLINGS

### JSEAL™ / JIC

### TP280

JSEAL™ / JIC FEMALE  
CONVEX SEAT  
90° LONG TUBE BEND

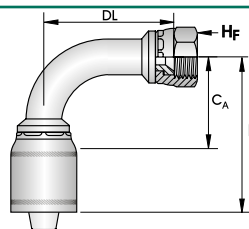

PART NO.	HOSE SIZE		THREAD SIZE	TUBE SIZE	DASH SIZE	DIMENSIONS						SPANNER			
	DN	inch	inch			L		C <sub>A</sub>		D <sub>L</sub>		H <sub>F</sub>		H <sub>M</sub>	
TP280-0609	10	3/8	9/16" -18		-0609	3.11	79	2.05	52	2.17	55	11/16			
TP280-0612	10	3/8	3/4" -16		-0612	3.39	86	2.32	59	2.52	64	7/8	22		

### JSEAL™ / JIC

### TP281

JSEAL™ / JIC FEMALE  
CONVEX SEAT  
90° LONG TUBE BEND  
METRIC NUT ONLY

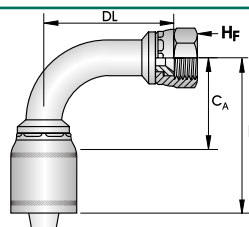

PART NO.	HOSE SIZE		THREAD SIZE	TUBE SIZE	DASH SIZE	DIMENSIONS						SPANNER			
	DN	inch	inch			L		C <sub>A</sub>		D <sub>L</sub>		H <sub>F</sub>		H <sub>M</sub>	
TP281-0609	10	3/8	9/16" -18		-0609	3.11	79	2.05	52	2.17	55	3/4	19		

### METRIC - DKL

### TP650

DKL MALE  
24° SEAT

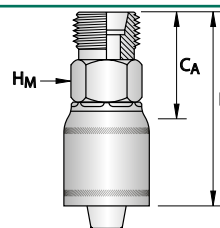

PART NO.	HOSE SIZE		THREAD SIZE	TUBE SIZE	DASH SIZE	DIMENSIONS						SPANNER			
	DN	inch	mm	mm		L		C <sub>A</sub>		D <sub>L</sub>		H <sub>F</sub>		H <sub>M</sub>	
TP650-0412	6	1/4	M 12X1,5	6	-0412	2.17	55	0.98	25					inch	mm
TP650-0414	6	1/4	M 14X1,5	8	-0414	2.17	55	0.98	25						14
TP650-0416	6	1/4	M 16X1,5	10	-0416	2.20	56	1.14	29						17
TP650-0516	8	5/16	M 16X1,5	10	-0516	2.20	56	1.14	29						17
TP650-0518	8	5/16	M 18X1,5	12	-0518	2.09	53	1.06	27					3/4	19
TP650-0616	10	3/8	M 16X1,5	10	-0616	2.32	59	1.22	31						17
TP650-0618	10	3/8	M 18X1,5	12	-0618	2.32	59	1.22	31					3/4	19
TP650-0622	10	3/8	M 22X1,5	15	-0622	2.24	57	1.18	30					15/16	24
TP650-0822	12	1/2	M 22X1,5	15	-0822	2.52	64	1.34	34					7/8	22
TP650-0826	12	1/2	M 26X1,5	18	-0826	2.52	64	1.34	34					1.3/16	30
TP650-1230	19	3/4	M 30X2	22	-1230	2.64	67	1.30	33					1.1/4	32
TP650-1636	25	1	M 36X2	28	-1636	2.99	76	1.50	38					1.5/8	41

## TP000 SERIES ONE-PIECE CRIMP COUPLINGS

### METRIC - DKOL

### TP501

DKOL FEMALE  
24° CONE

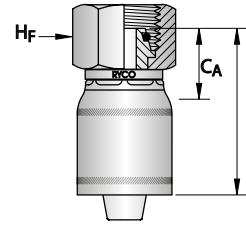

PART NO.	HOSE SIZE		THREAD SIZE	TUBE SIZE	DASH SIZE	DIMENSIONS						SPANNER			
	DN	inch	mm	mm		L		C <sub>A</sub>		D <sub>L</sub>		H <sub>F</sub>		H <sub>M</sub>	
						inch	mm	inch	mm	inch	mm	inch	mm		
TP501-0412	6	1/4	M 12X1,5	6	-0412	1.89	48	0.87	22				14		
TP501-0414	6	1/4	M 14X1,5	8	-0414	1.93	49	0.87	22				17		
TP501-0416	6	1/4	M 16X1,5	10	-0416	1.97	50	0.94	24			3/4	19		
TP501-0514	8	5/16	M 14X1,5	8	-0514	1.93	49	0.87	22				17		
TP501-0516	8	5/16	M 16X1,5	10	-0516	2.09	53	1.02	26			3/4	19		
TP501-0518	8	5/16	M 18X1,5	12	-0518	2.05	52	1.02	26			7/8	22		
TP501-0616	10	3/8	M 16X1,5	10	-0616	1.97	50	0.91	23			3/4	19		
TP501-0618	10	3/8	M 18X1,5	12	-0618	2.01	51	0.94	24			7/8	22		
TP501-0822	12	1/2	M 22X1,5	15	-0822	2.20	56	0.98	25			1.1/16	27		
TP501-0826	12	1/2	M 26X1,5	18	-0826	2.28	58	1.10	28			1.1/4	32		
TP501-1226	19	3/4	M 26X1,5	18	-1226	2.52	64	1.18	30			1.1/4	32		
TP501-1230	19	3/4	M 30X2	22	-1230	2.44	62	1.14	29				36		
TP501-1636	25	1	M 36X2	28	-1636	2.83	72	1.34	34			1.5/8	41		

### METRIC - DKOL

### TP510

DKOL FEMALE  
24° CONE  
45° TUBE BEND

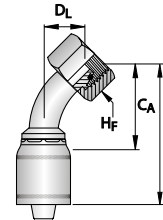

PART NO.	HOSE SIZE		THREAD SIZE	TUBE SIZE	DASH SIZE	DIMENSIONS						SPANNER			
	DN	inch	mm	mm		L		C <sub>A</sub>		D <sub>L</sub>		H <sub>F</sub>		H <sub>M</sub>	
						inch	mm	inch	mm	inch	mm	inch	mm		
TP510-0412	6	1/4	M 12X1,5	6	-0412	2.44	62	1.42	36	0.71	18		14		
TP510-0414	6	1/4	M 14X1,5	8	-0414	2.44	62	1.38	35	0.67	17		17		
TP510-0516	8	5/16	M 16X1,5	10	-0516	2.13	54	1.06	27	1.22	31	3/4	19		
TP510-0518	8	5/16	M 18X1,5	12	-0518	2.52	64	1.46	37	0.79	20	7/8	22		
TP510-0616	10	3/8	M 16X1,5	10	-0616	2.83	72	1.77	45	0.75	19	3/4	19		
TP510-0618	10	3/8	M 18X1,5	12	-0618	2.83	72	1.77	45	0.79	20	7/8	22		
TP510-0822	12	1/2	M 22X1,5	15	-0822	3.19	81	2.01	51	0.87	22	1.1/16	27		
TP510-1230	19	3/4	M 30X2	22	-1230	4.21	107	2.87	73	1.22	31		36		
TP510-1636	25	1	M 36X2	28	-1636	5.00	127	3.58	91	1.81	46	1.5/8	41		

# ONE-PIECE COUPLINGS

## TP000 SERIES ONE-PIECE CRIMP COUPLINGS

### METRIC - DKOL

### TP520

DKOL FEMALE  
24° CONE  
90° TUBE BEND

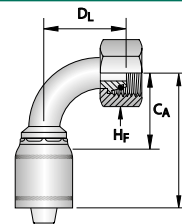

PART NO.	HOSE SIZE		THREAD SIZE	TUBE SIZE	DASH SIZE	DIMENSIONS						SPANNER			
	DN	inch	mm	mm		L		CA		DL		HF		HM	
	DN	inch	mm	mm		inch	mm	inch	mm	inch	mm	inch	mm		
TP520-0412	6	1/4	M 12X1,5	6	-0412	2.20	56	1.06	27	1.22	31		14		
TP520-0414	6	1/4	M 14X1,5	8	-0414	2.17	55	1.02	26	1.22	31		17		
TP520-0416	6	1/4	M 16X1,5	10	-0416	2.13	54	1.06	27	1.22	31	3/4	19		
TP520-0516	8	5/16	M 16X1,5	10	-0516	2.13	54	1.06	27	1.22	31	3/4	19		
TP520-0518	8	5/16	M 18X1,5	12	-0518	2.13	54	1.06	27	1.42	36	7/8	22		
TP520-0616	10	3/8	M 16X1,5	10	-0616	2.40	61	1.34	34	1.38	35	3/4	19		
TP520-0618	10	3/8	M 18X1,5	12	-0618	2.48	63	1.42	36	1.38	35	7/8	22		
TP520-0822	12	1/2	M 22X1,5	15	-0822	2.76	70	1.57	40	1.73	44	1.1/16	27		
TP520-0826	12	1/2	M 26X1,5	18	-0826	2.76	70	1.57	40	1.89	48	1.1/4	32		
TP520-1230	19	3/4	M 30X2	22	-1230	3.54	90	2.20	56	2.56	65		36		
TP520-1636	25	1	M 36X2	28	-1636	4.13	105	2.72	69	3.11	79	1.5/8	41		

### METRIC - DKS

### TP630

DKS MALE  
24° SEAT

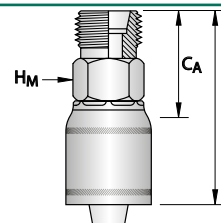

PART NO.	HOSE SIZE		THREAD SIZE	TUBE SIZE	DASH SIZE	DIMENSIONS						SPANNER			
	DN	inch	mm			L		CA		DL		HF		HM	
	DN	inch	mm			inch	mm	inch	mm					inch	mm
TP630-0416	6	1/4	M 16X1,5		-0416	2.24	57	1.06	27						17
TP630-0418	6	1/4	M 18X1,5		-0418	2.13	54	0.91	23					3/4	19
TP630-0520	8	5/16	M 20X1,5		-0520	2.32	59	1.26	32					7/8	22
TP630-0620	10	3/8	M 20X1,5		-0620	2.36	60	1.26	32					7/8	22
TP630-0622	10	3/8	M 22X1,5		-0622	2.32	59	1.22	31					15/16	24
TP630-0824	12	1/2	M 24X1,5		-0824	2.44	62	1.22	31					1.1/16	27
TP630-1230	19	3/4	M 30X2		-1230	2.80	71	1.46	37					1.1/4	32
TP630-1236	19	3/4	M 36X2		-1236	2.87	73	1.54	39					1.5/8	41
TP630-1642	25	1	M 42X2		-1642	3.23	82	1.73	44						46

## TP000 SERIES ONE-PIECE CRIMP COUPLINGS

### METRIC - DKOS

### TP711

DKOS FEMALE  
24° CONE

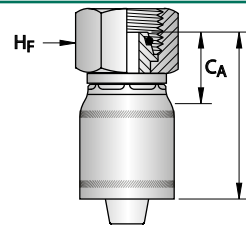

PART NO.	HOSE SIZE		THREAD SIZE	TUBE SIZE	DASH SIZE	DIMENSIONS				SPANNER			
	DN	inch	mm	mm		L		CA		DF		HM	
	DN	inch	mm	mm		inch	mm	inch	mm	inch	mm	inch	mm
TP711-0414	6	1/4	M 14X1,5	6	-0414	1.93	49	0.79	20				17
TP711-0416	6	1/4	M 16X1,5	8	-0416	2.09	53	0.91	23			3/4	19
TP711-0418	6	1/4	M 18X1,5	10	-0418	2.13	54	0.98	25			7/8	22
TP711-0518	8	5/16	M 18X1,5	10	-0518	2.13	54	1.06	27			7/8	22
TP711-0520	8	5/16	M 20X1,5	12	-0520	2.13	54	1.06	27			15/16	24
TP711-0620	10	3/8	M 20X1,5	12	-0620	2.13	54	1.06	27			15/16	24
TP711-0622	10	3/8	M 22X1,5	14	-0622	2.20	56	1.14	29			1.1/16	27
TP711-0624	10	3/8	M 24X1,5	16	-0624	2.20	56	1.14	29			1.3/16	30
TP711-0824	12	1/2	M 24X1,5	16	-0824	2.32	59	1.10	28			1.3/16	30
TP711-1230	19	3/4	M 30X2	20	-1230	2.60	66	1.30	33				36
TP711-1236	19	3/4	M 36X2	25	-1236	2.76	70	1.42	36				46
TP711-1642	25	1	M 42X2	30	-1642	2.95	75	1.50	38			2	50

### METRIC - DKOS

### TP720

DKOS FEMALE  
24° CONE  
45° TUBE BEND

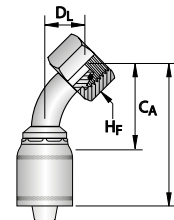

PART NO.	HOSE SIZE		THREAD SIZE	TUBE SIZE	DASH SIZE	DIMENSIONS				SPANNER			
	DN	inch	mm	mm		L		CA		DF		HM	
	DN	inch	mm	mm		inch	mm	inch	mm	inch	mm	inch	mm
TP720-0414	6	1/4	M 14X1,5	6	-0414	2.52	64	1.38	35	0.63	16		17
TP720-0416	6	1/4	M 16X1,5	8	-0416	2.56	65	1.42	36	0.67	17	3/4	19
TP720-0418	6	1/4	M 18X1,5	10	-0418	2.52	64	1.38	35	0.67	17	7/8	22
TP720-0518	8	5/16	M 18X1,5	10	-0518	2.44	62	1.38	35	0.67	17	7/8	22
TP720-0520	8	5/16	M 20X1,5	12	-0520	2.87	73	1.81	46	0.79	20	15/16	24
TP720-0620	10	3/8	M 20X1,5	12	-0620	2.87	73	1.81	46	0.79	20	15/16	24
TP720-0622	10	3/8	M 22X1,5	14	-0622	2.87	73	1.81	46	0.79	20	1.1/16	27
TP720-0824	12	1/2	M 24X1,5	16	-0824	3.27	83	2.09	53	0.94	24	1.3/16	30
TP720-1230	19	3/4	M 30X2	20	-1230	4.25	108	2.91	74	1.38	35		36
TP720-1236	19	3/4	M 36X2	25	-1236	4.33	110	2.99	76	1.38	35		46
TP720-1642	25	1	M 42X2	30	-1642	4.84	123	3.43	87	1.46	37	2	50

# ONE-PIECE COUPLINGS

## TP000 SERIES ONE-PIECE CRIMP COUPLINGS

### METRIC - DKOS

### TP730

DKOS FEMALE  
24° CONE  
90° TUBE BEND

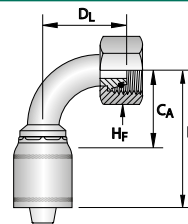

PART NO.	HOSE SIZE		THREAD SIZE	TUBE SIZE	DASH SIZE	DIMENSIONS						SPANNER		
	DN	inch	mm	mm		L		CA		DL		HF		HM
	DN	inch	mm	mm		inch	mm	inch	mm	inch	mm	inch	mm	
TP730-0414	6	1/4	M 14X1,5	6	-0414	2.20	56	1.06	27	1.10	28		17	
TP730-0416	6	1/4	M 16X1,5	8	-0416	2.20	56	1.06	27	1.22	31	3/4	19	
TP730-0418	6	1/4	M 18X1,5	10	-0418	2.20	56	1.06	27	1.14	29	7/8	22	
TP730-0520	8	5/16	M 20X1,5	12	-0520	2.48	63	1.42	36	1.42	36	15/16	24	
TP730-0620	10	3/8	M 20X1,5	12	-0620	2.48	63	1.42	36	1.42	36	15/16	24	
TP730-0622	10	3/8	M 22X1,5	14	-0622	2.48	63	1.42	36	1.42	36	1.1/16	27	
TP730-0824	12	1/2	M 24X1,5	16	-0824	2.76	70	1.57	40	1.89	48	1.3/16	30	
TP730-1230	19	3/4	M 30X2	20	-1230	3.43	87	2.13	54	2.68	68		36	
TP730-1236	19	3/4	M 36X2	25	-1236	3.50	89	2.17	55	2.68	68		46	
TP730-1642	25	1	M 42X2	30	-1642	4.13	105	2.72	69	3.03	77	2	50	

### METRIC

### TP470

METRIC BANJO

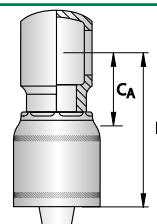

PART NO.	HOSE SIZE		THREAD SIZE	TUBE SIZE	DASH SIZE	DIMENSIONS						SPANNER	
	DN	inch				L		CA		DL	HF	HM	
	DN	inch				inch	mm	inch	mm				
TP470-0412	6	1/4			-0412	1.97	50	0.91	23				
TP470-0414	6	1/4			-0414	2.05	52	0.98	25				
TP470-0614	10	3/8			-0614	2.17	55	1.06	27				
TP470-0618	10	3/8			-0618	2.24	57	1.14	29				
TP470-0622	10	3/8			-0622	2.44	62	1.38	35				
TP470-0818	12	1/2			-0818	2.36	60	1.14	29				
TP470-0822	12	1/2			-0822	2.48	63	1.26	32				

## TP000 SERIES ONE-PIECE CRIMP COUPLINGS

### STANDPIPE

### TP640

METRIC STANDPIPE

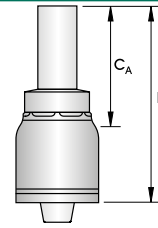

PART NO.	HOSE SIZE		THREAD SIZE	TUBE SIZE	DASH SIZE	DIMENSIONS				SPANNER			
	DN	inch				inch	mm	inch	mm	inch	mm	H <sub>F</sub>	H <sub>M</sub>
TP640-0306	5	3/16		6	-0306	2.20	56	1.22	31				
TP640-0406	6	1/4		6	-0406	2.28	58	1.22	31				
TP640-0408	6	1/4		8	-0408	2.28	58	1.22	31				
TP640-0410	6	1/4		10	-0410	2.40	61	1.34	34				
TP640-0612	10	3/8		12	-0612	2.44	62	1.34	34				
TP640-0815	12	1/2		15	-0815	2.52	64	1.34	34				
TP640-0816	12	1/2		16	-0816	2.72	69	1.54	39				

### STANDPIPE

### TP643

METRIC STANDPIPE  
45° TUBE BEND

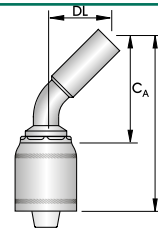

PART NO.	HOSE SIZE		THREAD SIZE	TUBE SIZE	DASH SIZE	DIMENSIONS				SPANNER			
	DN	inch				inch	mm	inch	mm	inch	mm	H <sub>F</sub>	H <sub>M</sub>
TP643-0306	5	3/16		6	-0306	2.68	68	1.65	42	0.83	21		
TP643-0410	6	1/4		10	-0410	2.72	69	1.65	42	0.94	24		

### STANDPIPE

### TP646

METRIC STANDPIPE  
90° TUBE BEND

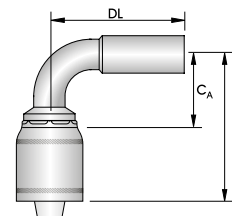

PART NO.	HOSE SIZE		THREAD SIZE	TUBE SIZE	DASH SIZE	DIMENSIONS				SPANNER			
	DN	inch				inch	mm	inch	mm	inch	mm	H <sub>F</sub>	H <sub>M</sub>
TP646-0306	5	3/16		6	-0306	2.05	52	1.02	26	1.34	34		
TP646-0410	6	1/4		10	-0410	2.13	54	1.06	27	1.61	41		

INTRODUCTION

INDEXES

ONE-PIECE  
COUPLINGS

PUSH-ON SUCTION &  
RETURN COUPLINGS

FIELD ATTACHABLE  
COUPLINGS

HYDRAULIC FITTINGS  
ACCESSORIES

# ONE-PIECE COUPLINGS

## TP000 SERIES ONE-PIECE CRIMP COUPLINGS

ORFS

TP800

ORFS FEMALE  
METRIC NUT ONLY

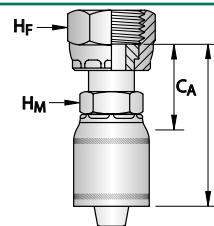

PART NO.	HOSE SIZE		THREAD SIZE	TUBE SIZE	DASH SIZE	DIMENSIONS				SPANNER					
	DN	inch	inch	inch		L		C <sub>A</sub>		D <sub>L</sub>		H <sub>F</sub>		H <sub>M</sub>	
						inch	mm	inch	mm			inch	mm	inch	mm
TP800-0409	6	1/4	9/16" - 18	-	-0409	2.28	58	1.22	31			11/16		9/16	
TP800-0411	6	1/4	11/16" - 16	-	-0411	2.44	62	1.42	36			13/16		11/16	
TP800-0511	8	5/16	11/16" - 16	-	-0511	2.44	62	1.42	36			13/16		5/8	16
TP800-0611	10	3/8	11/16" - 16	-	-0611	2.36	60	1.30	33			13/16		5/8	16
TP800-0613	10	3/8	13/16" - 16	-	-0613	2.56	65	1.46	37			15/16	24	3/4	19
TP800-0813	12	1/2	13/16" - 16	-	-0813	2.60	66	1.42	36			15/16	24	3/4	19
TP800-1219	19	3/4	1.3/16" - 12	-	-1219	3.19	81	1.77	45			1.3/8	35	1.1/8	
TP800-1223	19	3/4	1.7/16" - 12	-	-1223	3.46	88	2.13	54			1.5/8	41	1.3/8	35
TP800-1623	25	1	1.7/16" - 12	-	-1623	3.62	92	2.17	55			1.5/8	41	1.3/8	35

ORFS

TP801

ORFS FEMALE  
METRIC NUT ONLY

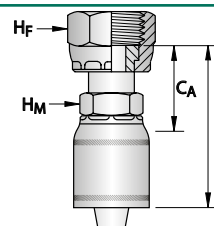

PART NO.	HOSE SIZE		THREAD SIZE	TUBE SIZE	DASH SIZE	DIMENSIONS				SPANNER					
	DN	inch	inch			L		C <sub>A</sub>		D <sub>L</sub>		H <sub>F</sub>		H <sub>M</sub>	
						inch	mm	inch	mm			inch	mm		
TP801-0409	6	1/4	9/16" - 18		-0409	2.28	58	1.22	31			17			
TP801-0411	6	1/4	11/16" - 16		-0411	2.44	62	1.42	36			7/8	22		
TP801-0511	8	5/16	11/16" - 16		-0511	2.44	62	1.42	36			7/8	22		
TP801-1219	19	3/4	1.3/16" - 12		-1219	3.19	81	1.77	45			36			

## TP000 SERIES ONE-PIECE CRIMP COUPLINGS

### ORFS TP810

ORFS FEMALE  
45° TUBE BEND

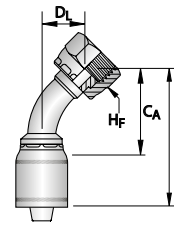

PART NO.	HOSE SIZE		THREAD SIZE	TUBE SIZE	DASH SIZE	DIMENSIONS						SPANNER		
	DN	inch	inch			L		C <sub>A</sub>		D <sub>L</sub>		H <sub>F</sub>		H <sub>M</sub>
TP810-0409	6	1/4	9/16" - 18		-0409	2.60	66	1.57	40	0.71	18	11/16		
TP810-0411	6	1/4	11/16" - 16		-0411	2.60	66	1.57	40	0.71	18	13/16		
TP810-0611	10	3/8	11/16" - 16		-0611	2.83	72	1.77	45	0.79	20	13/16		
TP810-0613	10	3/8	13/16" - 16		-0613	2.64	67	1.57	40	0.67	17	15/16	24	
TP810-0813	12	1/2	13/16" - 16		-0813	3.07	78	1.89	48	0.75	19	15/16	24	
TP810-1219	19	3/4	1.3/16" - 12		-1219	3.86	98	2.52	64	1.14	29	1.3/8	35	

### ORFS TP811

ORFS FEMALE  
45° TUBE BEND  
METRIC NUT ONLY

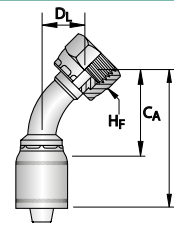

PART NO.	HOSE SIZE		THREAD SIZE	TUBE SIZE	DASH SIZE	DIMENSIONS						SPANNER		
	DN	inch	inch			L		C <sub>A</sub>		D <sub>L</sub>		H <sub>F</sub>		H <sub>M</sub>
TP811-0409	6	1/4	9/16" - 18		-0409	2.60	66	1.57	40	0.71	18	17		
TP811-1219	19	3/4	1.3/16" - 12		-1219	3.86	98	2.52	64	1.14	29	36		

### ORFS TP820

ORFS FEMALE  
90° MEDIUM TUBE BEND

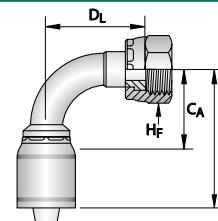

PART NO.	HOSE SIZE		THREAD SIZE	TUBE SIZE	DASH SIZE	DIMENSIONS						SPANNER		
	DN	inch	inch			L		C <sub>A</sub>		D <sub>L</sub>		H <sub>F</sub>		H <sub>M</sub>
TP820-0409	6	1/4	9/16" - 18		-0409	2.17	55	1.14	29	1.26	32	11/16		
TP820-0411	6	1/4	11/16" - 16		-0411	2.32	59	1.30	33	1.50	38	13/16		
TP820-0511	8	5/16	11/16" - 16		-0511	2.32	59	1.30	33	1.50	38	13/16		
TP820-0611	10	3/8	11/16" - 16		-0611	2.40	61	1.34	34	1.50	38	13/16		
TP820-0613	10	3/8	13/16" - 16		-0613	2.64	67	1.57	40	1.34	34	15/16	24	
TP820-0813	12	1/2	13/16" - 16		-0813	2.68	68	1.50	38	1.61	41	15/16	24	
TP820-1219	19	3/4	1.3/16" - 12		-1219	5.04	128	3.62	92	2.32	59	1.3/8	35	
TP820-1623	25	1	1.7/16" - 12		-1623	4.13	105	2.72	69	2.80	71	1.5/8	41	

# ONE-PIECE COUPLINGS

## TP000 SERIES ONE-PIECE CRIMP COUPLINGS

### ORFS

### TP821

ORFS FEMALE  
90° MEDIUM TUBE BEND  
METRIC NUT ONLY

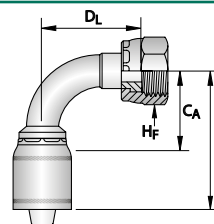

PART NO.	HOSE SIZE		THREAD SIZE	TUBE SIZE	DASH SIZE	DIMENSIONS						SPANNER			
	DN	inch	inch			L		C <sub>A</sub>		D <sub>L</sub>		H <sub>F</sub>		H <sub>M</sub>	
						inch	mm	inch	mm	inch	mm	inch	mm		
TP821-0409	6	1/4	9/16" - 18		-0409	2.17	55	1.14	29	1.26	32		17		
TP821-1219	19	3/4	1.3/16" - 12		-1219	5.04	128	3.62	92	2.32	59		36		

### SAE

### TP540

SAE FEMALE  
45° FLARE

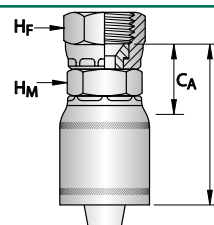

PART NO.	HOSE SIZE		THREAD SIZE	TUBE SIZE	DASH SIZE	DIMENSIONS						SPANNER			
	DN	inch	inch			L		C <sub>A</sub>		D <sub>L</sub>		H <sub>F</sub>		H <sub>M</sub>	
						inch	mm	inch	mm			inch	mm	inch	mm
TP540-0410	6	1/4	5/8" -18		-0410	2.05	52	0.98	25			3/4	19	5/8	16
TP540-0510	8	5/16	5/8" -18		-0510	2.05	52	1.02	26			3/4	19	5/8	16
TP540-0610	10	3/8	5/8" -18		-0610	2.05	52	0.98	25			3/4	19	5/8	16

### SAE

### TP570

SAE FEMALE  
45° FLARE  
90° ELBOW

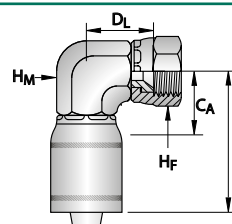

PART NO.	HOSE SIZE		THREAD SIZE	TUBE SIZE	DASH SIZE	DIMENSIONS						SPANNER			
	DN	inch	inch			L		C <sub>A</sub>		D <sub>L</sub>		H <sub>F</sub>		H <sub>M</sub>	
						inch	mm	inch	mm	inch	mm	inch	mm	inch	mm
TP570-0610	10	3/8	5/8" -18		-0610	1.97	50	0.91	23	0.91	23	3/4	19	3/4	19

# TT000 SERIES ONE-PIECE CRIMP COUPLINGS

## HOSE COMPATIBILITY FOR TT000 SERIES

### NON-SKIVE

For Ryco Hose Series RTH1 (all sizes).

### SKIVE

## BSPT

## TT010

BSPT MALE  
60° SEAT

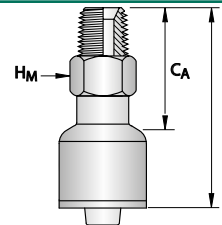

PART NO.	HOSE SIZE		THREAD SIZE	TUBE SIZE	DASH SIZE	DIMENSIONS				SPANNER					
	DN	inch				inch	L		C <sub>A</sub>		D <sub>L</sub>		H <sub>F</sub>		H <sub>M</sub>
						inch	mm	inch	mm					inch	mm
TT010-0404	6	1/4	1/4" -19		-0404	2.09	53	1.18	30					9/16	
TT010-0604	10	3/8	1/4" -19		-0604	2.24	57	1.30	33					5/8	16
TT010-0606	10	3/8	3/8" -19		-0606	2.24	57	1.30	33					11/16	
TT010-0608	10	3/8	1/2" -14		-0608	2.44	62	1.46	37					7/8	22
TT010-0806	12	1/2	3/8" -19		-0806	2.44	62	1.38	35					11/16	
TT010-0808	12	1/2	1/2" -14		-0808	2.64	67	1.57	40					7/8	22
TT010-1212	19	3/4	3/4" -14		-1212	2.95	75	1.61	41					1.1/16	27
TT010-1616	25	1	1" -11		-1616	3.31	84	1.89	48					1.3/8	35

## BSPT

## TT320

BSPT MALE SWIVEL  
60° SEAT

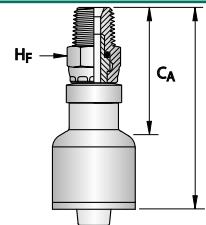

PART NO.	HOSE SIZE		THREAD SIZE	TUBE SIZE	DASH SIZE	DIMENSIONS				SPANNER					
	DN	inch				inch	L		C <sub>A</sub>		D <sub>L</sub>		H <sub>F</sub>		H <sub>M</sub>
						inch	mm	inch	mm			inch			
TT320-0808	12	1/2	1/2" -14		-0808	2.91	74	1.81	46			1			

INTRODUCTION

INDEXES

ONE-PIECE  
COUPLINGS

PUSH-ON SUCTION &  
RETURN COUPLINGS

FIELD ATTACHABLE  
COUPLINGS

HYDRAULIC FITTINGS  
ACCESSORIES

# ONE-PIECE COUPLINGS

## TT000 SERIES ONE-PIECE CRIMP COUPLINGS

**BSPP**

**TT020**

BSPP FEMALE  
60° CONE

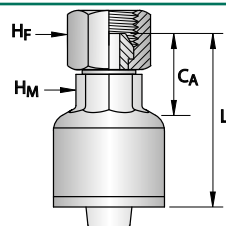

PART NO.	HOSE SIZE		THREAD SIZE	TUBE SIZE	DASH SIZE	DIMENSIONS						SPANNER			
	DN	inch	inch			L		C <sub>A</sub>		D <sub>L</sub>		H <sub>F</sub>		H <sub>M</sub>	
	DN	inch	inch			inch	mm	inch	mm	inch	mm	inch	mm	inch	mm
TT020-0404	6	1/4	1/4" -19		-0404	1.81	46	0.94	24			3/4	19	1/2	
TT020-0606	10	3/8	3/8" -19		-0606	2.01	51	1.06	27			7/8	22	5/8	16
TT020-0808	12	1/2	1/2" -14		-0808	2.20	56	1.14	29			1.1/16	27	3/4	19
TT020-1008	16	5/8	1/2" -14		-1008	2.40	61	1.06	27			1.1/16	27	1	
TT020-1212	19	3/4	3/4" -14		-1212	2.44	65	1.10	31			1.1/4	32	1	
TT020-1616	25	1	1" -11		-1616	2.87	73	1.46	36			1.1/2	38	1.1/4	32

**BSPP**

**TT050**

BSPP FEMALE  
60° CONE  
90° ELBOW

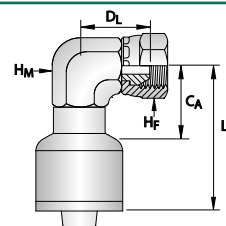

PART NO.	HOSE SIZE		THREAD SIZE	TUBE SIZE	DASH SIZE	DIMENSIONS						SPANNER			
	DN	inch	inch			L		C <sub>A</sub>		D <sub>L</sub>		H <sub>F</sub>		H <sub>M</sub>	
	DN	inch	inch			inch	mm	inch	mm	inch	mm	inch	mm	inch	mm
TT050-0808	12	1/2	1/2" -14		-0808	2.24	57	1.14	29	1.22	31	1.1/16	27	7/8	22

**BSPP**

**TT260**

BSPP FEMALE  
60° CONE  
90° TUBE BEND

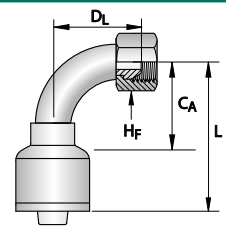

PART NO.	HOSE SIZE		THREAD SIZE	TUBE SIZE	DASH SIZE	DIMENSIONS						SPANNER			
	DN	inch	inch			L		C <sub>A</sub>		D <sub>L</sub>		H <sub>F</sub>		H <sub>M</sub>	
	DN	inch	inch			inch	mm	inch	mm	inch	mm	inch	mm	inch	mm
TT260-0404	6	1/4	1/4" -19		-0404	1.97	50	1.06	27	1.14	29	3/4	19		
TT260-0606	10	3/8	3/8" -19		-0606	2.32	59	1.38	35	1.30	33	7/8	22		
TT260-0808	12	1/2	1/2" -14		-0808	2.56	65	1.50	38	1.77	45	1.1/16	27		
TT260-1212	19	3/4	3/4" -14		-1212	3.46	88	2.17	55	2.32	59	1.1/4	32		
TT260-1616	25	1	1" -11		-1616	4.09	104	2.68	68	3.07	78	1.1/2	38		

## TT000 SERIES ONE-PIECE CRIMP COUPLINGS

### JIC TT030

JIC  
37° CONE  
MALE

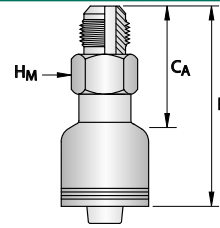

PART NO.	HOSE SIZE		THREAD SIZE	TUBE SIZE	DASH SIZE	DIMENSIONS				SPANNER					
	DN	inch	inch			L		C <sub>A</sub>		D <sub>L</sub>		H <sub>F</sub>		H <sub>M</sub>	
						inch	mm	inch	mm					inch	mm
TT030-0407	6	1/4	7/16" -20		-0407	2.05	52	1.14	29					1/2	
TT030-0408	6	1/4	1/2" - 20		-0408	2.05	52	1.14	29					9/16	
TT030-0409	6	1/4	9/16" -18		-0409	2.05	52	1.18	30					5/8	16
TT030-0609	10	3/8	9/16" -18		-0609	2.24	57	1.26	32					5/8	16
TT030-0612	10	3/8	3/4" -16		-0612	2.32	59	1.38	35					3/4	19
TT030-0812	12	1/2	3/4" -16		-0812	2.52	64	1.46	37					3/4	19
TT030-0814	12	1/2	7/8" -14		-0814	2.64	67	1.54	39					15/16	24

### JIC TT031

JIC  
37° CONE MALE  
METRIC HEX ONLY

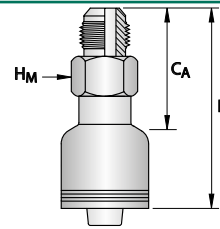

PART NO.	HOSE SIZE		THREAD SIZE	TUBE SIZE	DASH SIZE	DIMENSIONS				SPANNER					
	DN	inch	inch			L		C <sub>A</sub>		D <sub>L</sub>		H <sub>F</sub>		H <sub>M</sub>	
						inch	mm	inch	mm					inch	mm
TT031-0407	6	1/4	7/16" -20		-0407	2.05	52	1.14	29						12

INTRODUCTION

INDEXES

ONE-PIECE  
COUPLINGS

PUSH-ON SUCTION &  
RETURN COUPLINGS

FIELD ATTACHABLE  
COUPLINGS

HYDRAULIC FITTINGS  
ACCESSORIES

# ONE-PIECE COUPLINGS

## TT000 SERIES ONE-PIECE CRIMP COUPLINGS

JSEAL™ / JIC

TT040

JSEAL™ / JIC FEMALE  
CONVEX SEAT

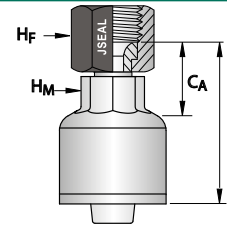

PART NO.	HOSE SIZE		THREAD SIZE	TUBE SIZE	DASH SIZE	DIMENSIONS						SPANNER			
	DN	inch	inch			L		C <sub>A</sub>		D <sub>L</sub>		H <sub>F</sub>		H <sub>M</sub>	
						inch	mm	inch	mm			inch	mm	inch	mm
TT040-0407	6	1/4	7/16" -20		-0407	1.73	44	0.87	22			9/16		1/2	
TT040-0408	6	1/4	1/2" - 20		-0408	1.73	44	0.87	22			5/8	16	1/2	
TT040-0409	6	1/4	9/16" -18		-0409	1.77	45	0.87	22			11/16		9/16	
TT040-0609	10	3/8	9/16" -18		-0609	1.85	47	0.87	22			11/16		9/16	
TT040-0612	10	3/8	3/4" -16		-0612	1.93	50	0.94	25			7/8	22	11/16	
TT040-0812	12	1/2	3/4" -16		-0812	2.01	51	0.94	24			7/8	22	5/8	16
TT040-0814	12	1/2	7/8" -14		-0814	2.13	54	1.06	27			1		5/8	16
TT040-1014	16	5/8	7/8" -14		-1014	2.40	61	1.06	27			1		7/8	22
TT040-1017	16	5/8	1.1/16" -12		-1017	2.48	63	1.14	29			1.1/4	32	1	
TT040-1214	19	3/4	7/8" -14		-1214	2.44	66	1.14	32			1		1	
TT040-1217	19	3/4	1.1/16" -12		-1217	2.48	62	1.14	29			1.1/4	32	1	
TT040-1621	25	1	1.5/16" -12		-1621	2.83	72	1.42	33			1.1/2	38	1.1/4	32

JSEAL™ / JIC

TT041

JSEAL™ / JIC FEMALE  
CONVEX SEAT  
METRIC NUT ONLY

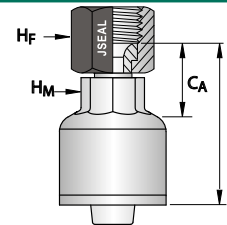

PART NO.	HOSE SIZE		THREAD SIZE	TUBE SIZE	DASH SIZE	DIMENSIONS						SPANNER			
	DN	inch	inch			L		C <sub>A</sub>		D <sub>L</sub>		H <sub>F</sub>		H <sub>M</sub>	
						inch	mm	inch	mm			inch	mm	inch	mm
TT041-0407	6	1/4	7/16" -20		-0407	1.54	39	0.67	17				14		
TT041-0409	6	1/4	9/16" -18		-0409	1.57	40	0.67	17			3/4	19		
TT041-0609	10	3/8	9/16" -18		-0609	1.65	47	0.67	22			3/4	19		14

JSEAL™ / JIC

TT250

JSEAL™ / JIC FEMALE  
CONVEX SEAT  
45° TUBE BEND

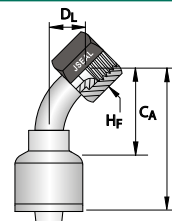

PART NO.	HOSE SIZE		THREAD SIZE	TUBE SIZE	DASH SIZE	DIMENSIONS						SPANNER			
	DN	inch	inch			L		C <sub>A</sub>		D <sub>L</sub>		H <sub>F</sub>		H <sub>M</sub>	
						inch	mm	inch	mm	inch	mm	inch	mm	inch	mm
TT250-0609	10	3/8	9/16" -18		-0609	2.48	63	1.50	38	0.55	14	11/16			
TT250-0814	12	1/2	7/8" -14		-0814	2.91	74	1.85	47	0.87	22	1			

## TT000 SERIES ONE-PIECE CRIMP COUPLINGS

### JSEAL™ / JIC

### TT251

JSEAL™ / JIC FEMALE  
CONVEX SEAT  
45° TUBE BEND  
METRIC NUT ONLY

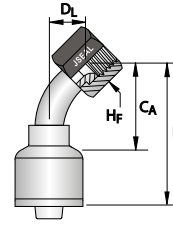

PART NO.	HOSE SIZE		THREAD SIZE	TUBE SIZE	DASH SIZE	DIMENSIONS						SPANNER		
	DN	inch	inch			L		C <sub>A</sub>		D <sub>L</sub>		H <sub>F</sub>		H <sub>M</sub>
TT251-0609	10	3/8	9/16" -18		-0609	2.48	63	1.50	38	0.55	14	3/4	19	

### JSEAL™ / JIC

### TT240

JSEAL™ / JIC FEMALE  
CONVEX SEAT  
90° TUBE BEND

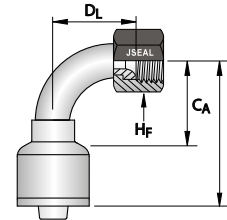

PART NO.	HOSE SIZE		THREAD SIZE	TUBE SIZE	DASH SIZE	DIMENSIONS						SPANNER		
	DN	inch	inch			L		C <sub>A</sub>		D <sub>L</sub>		H <sub>F</sub>		H <sub>M</sub>
TT240-0407	6	1/4	7/16" -20		-0407	1.93	49	1.02	26	1.26	32	9/16		
TT240-0408	6	1/4	1/2" - 20		-0408	1.93	49	1.02	26	1.26	32	5/8	16	
TT240-0409	6	1/4	9/16" -18		-0409	1.93	49	1.02	26	1.50	38	11/16		
TT240-0609	10	3/8	9/16" -18		-0609	2.36	59	1.38	34	0.98	26	11/16		
TT240-0612	10	3/8	3/4" -16		-0612	2.32	59	1.38	35	1.18	30	7/8	22	
TT240-0812	12	1/2	3/4" -16		-0812	2.68	68	1.61	41	1.50	38	7/8	22	
TT240-0814	12	1/2	7/8" -14		-0814	2.68	68	1.61	41	1.61	41	1		
TT240-1014	16	5/8	7/8" -14		-1014	3.23	82	1.89	48	1.85	47	1		
TT240-1217	19	3/4	1.1/16" -12		-1217	3.50	90	2.20	57	2.24	57	1.1/4	32	
TT240-1621	25	1	1.5/16" -12		-1621	4.09	104	2.68	74	2.83	72	1.1/2	38	32

### JSEAL™ / JIC

### TT241

JSEAL™ / JIC FEMALE  
CONVEX SEAT  
90° TUBE BEND  
METRIC NUT ONLY

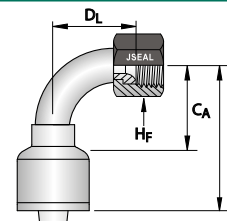

PART NO.	HOSE SIZE		THREAD SIZE	TUBE SIZE	DASH SIZE	DIMENSIONS						SPANNER		
	DN	inch	inch			L		C <sub>A</sub>		D <sub>L</sub>		H <sub>F</sub>		H <sub>M</sub>
TT241-0407	6	1/4	7/16" -20		-0407	1.93	49	1.02	26	1.26	32	14		
TT241-0409	6	1/4	9/16" -18		-0409	1.93	49	1.02	26	1.50	38	3/4	19	
TT241-0609	10	3/8	9/16" -18		-0609	2.36	59	1.38	34	0.98	26	3/4	19	

# ONE-PIECE COUPLINGS

## TT000 SERIES ONE-PIECE CRIMP COUPLINGS

**NPTF**

**TT090**

NPTF MALE  
60° SEAT

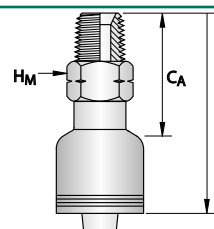

PART NO.	HOSE SIZE		THREAD SIZE	TUBE SIZE	DASH SIZE	DIMENSIONS						SPANNER			
	DN	inch	inch			L		C <sub>A</sub>		D <sub>L</sub>		H <sub>F</sub>		H <sub>M</sub>	
						inch	mm	inch	mm			inch	mm	inch	mm
TT090-0404	6	1/4	1/4" -18		-0404	2.09	53	1.18	30					9/16	
TT090-0606	10	3/8	3/8" -18		-0606	2.24	57	1.30	33					11/16	
TT090-0808	12	1/2	1/2" -14		-0808	2.64	67	1.57	40					7/8	22
TT090-1212	19	3/4	3/4" -14		-1212	2.95	75	1.61	41					1.1/16	27
TT090-1616	25	1	1" -11,5		-1616	3.31	84	1.89	48					1.3/8	35

**METRIC - DKL**

**TT600**

DKL FEMALE  
24°/60° CONE

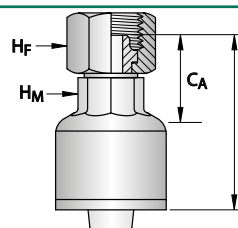

PART NO.	HOSE SIZE		THREAD SIZE	TUBE SIZE	DASH SIZE	DIMENSIONS						SPANNER			
	DN	inch	mm			L		C <sub>A</sub>		D <sub>L</sub>		H <sub>F</sub>		H <sub>M</sub>	
						inch	mm	inch	mm			inch	mm		
TT600-0414	6	1/4	M 14X1,5		-0414	1.73	44	0.87	22				17		
TT600-0822	12	1/2	M 22X1,5		-0822	2.09	53	0.98	25			1.1/16	27		

**METRIC - DKL**

**TT670**

DKL FEMALE  
24°/60°  
90° TUBE BEND

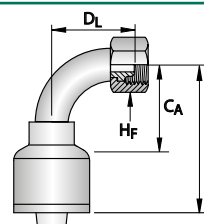

PART NO.	HOSE SIZE		THREAD SIZE	TUBE SIZE	DASH SIZE	DIMENSIONS						SPANNER			
	DN	inch	mm			L		C <sub>A</sub>		D <sub>L</sub>		H <sub>F</sub>		H <sub>M</sub>	
						inch	mm	inch	mm	inch	mm	inch	mm		
TT670-0414	6	1/4	M 14X1,5		-0414	1.97	50	1.06	27	1.22	31		17		
TT670-0822	12	1/2	M 22X1,5		-0822	2.64	67	1.57	40	1.73	44	1.1/16	27		

## TT000 SERIES ONE-PIECE CRIMP COUPLINGS

SAE

TT540

SAE FEMALE  
45° FLARE

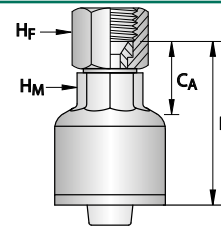

PART NO.	HOSE SIZE		THREAD SIZE	TUBE SIZE	DASH SIZE	DIMENSIONS						SPANNER			
	DN	inch	inch			L		C <sub>A</sub>		D <sub>L</sub>		H <sub>F</sub>		H <sub>M</sub>	
						inch	mm	inch	mm			inch	mm	inch	mm
TT540-0407	6	1/4	7/16" - 20		-0407	1.65	42	0.75	19			9/16		1/2	
TT540-0408	6	1/4	1/2" - 20		-0408	1.65	42	0.79	20			5/8	16	9/16	
TT540-0610	10	3/8	5/8" - 18		-0610	1.85	47	0.91	23			3/4	19	5/8	16
TT540-0612	10	3/8	3/4" - 16		-0612	1.81	46	0.87	22			7/8	22	11/16	
TT540-0812	12	1/2	3/4" - 16		-0812	2.05	52	0.98	25			7/8	22	11/16	
TT540-0814	12	1/2	7/8" - 14		-0814	2.09	53	0.98	25			1		13/16	
TT540-1014	16	5/8	7/8" - 14		-1014	2.32	59	0.98	25			1		13/16	
TT540-1017	16	5/8	1.1/16" - 12		-1017	2.36	60	1.02	26			1.1/4	32	1	
TT540-1214	19	3/4	7/8" - 14		-1214	2.32	59	1.02	26			1		1	
TT540-1217	19	3/4	1.1/16" - 12		-1217	2.36	60	1.06	27			1.1/4	32	1	

INTRODUCTION

INDEXES

ONE-PIECE  
COUPLINGS

PUSH-ON SUCTION &  
RETURN COUPLINGS

FIELD ATTACHABLE  
COUPLINGS

HYDRAULIC FITTINGS  
ACCESSORIES

# ONE-PIECE COUPLINGS

## TG000 SERIES ONE-PIECE CRIMP COUPLINGS

### HOSE COMPATIBILITY FOR TG000 SERIES

#### NON-SKIVE

For Ryco Hose Series TPGL (all sizes).

#### SKIVE

### BSPT

### TG010

BSPT MALE  
60° SEAT

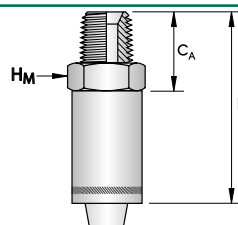

PART NO.	HOSE SIZE		THREAD SIZE	TUBE SIZE	DASH SIZE	DIMENSIONS				SPANNER					
	DN	inch	inch			L		CA		DL		HF		HM	
						inch	mm	inch	mm			inch	mm	inch	mm
TG010-0202	4	1/8	1/8" -28		-0202	1.93	49	1.02	26					7/16	11

### BSPT

### TG320

BSPT MALE SWIVEL  
60° SEAT

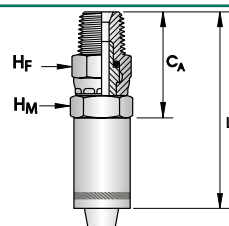

PART NO.	HOSE SIZE		THREAD SIZE	TUBE SIZE	DASH SIZE	DIMENSIONS				SPANNER					
	DN	inch	inch			L		CA		DL		HF		HM	
						inch	mm	inch	mm			inch	mm	inch	mm
TG320-0202	4	1/8	1/8" -28		-0202	1.81	46	0.91	23			1/2			

### BSPP

### TG020

BSPP FEMALE  
60° CONE

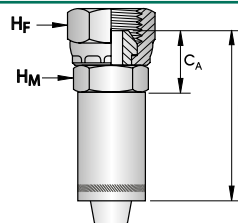

PART NO.	HOSE SIZE		THREAD SIZE	TUBE SIZE	DASH SIZE	DIMENSIONS				SPANNER				
	DN	inch	inch			L		CA		DL		HF		HM
						inch	mm	inch	mm			mm	inch	mm
TG020-0202	4	1/8	1/8" -28		-0202	1.85	47	0.94	24			14	7/16	11

## TG000 SERIES ONE-PIECE CRIMP COUPLINGS

### NPTF TG090

NPTF MALE  
60° SEAT

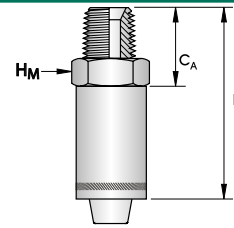

PART NO.	HOSE SIZE		THREAD SIZE	TUBE SIZE	DASH SIZE	DIMENSIONS				SPANNER		
	DN	inch	inch			L		C <sub>A</sub>		D <sub>L</sub>	H <sub>F</sub>	H <sub>M</sub>
						inch	mm	inch	mm			mm
TG090-0202	4	1/8	1/8" -27		-0202	1.93	49	1.02	26			12

### NPT TG320N

NPT MALE SWIVEL  
60° SEAT

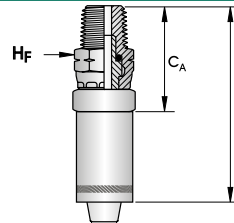

PART NO.	HOSE SIZE		THREAD SIZE	TUBE SIZE	DASH SIZE	DIMENSIONS				SPANNER		
	DN	inch	inch			L		C <sub>A</sub>		D <sub>L</sub>	H <sub>F</sub>	H <sub>M</sub>
						inch	mm	inch	mm		inch	
TG320N-0202	4	1/8	1/8" -27		-0202	1.81	46	0.91	23		11/16	

### NPSM TG020N

NPSM FEMALE  
60° SEAT

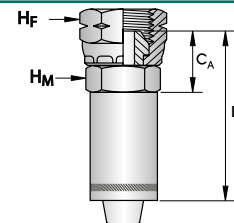

PART NO.	HOSE SIZE		THREAD SIZE	TUBE SIZE	DASH SIZE	DIMENSIONS				SPANNER			
	DN	inch	inch			L		C <sub>A</sub>		D <sub>L</sub>	H <sub>F</sub>	H <sub>M</sub>	
						inch	mm	inch	mm		inch	mm	
TG020N-0202	4	1/8	1/8" -27		-0202	1.89	48	0.98	25		9/16	7/16	11

INTRODUCTION

INDEXES

ONE-PIECE  
COUPLINGS

PUSH-ON SUCTION &  
RETURN COUPLINGS

FIELD ATTACHABLE  
COUPLINGS

HYDRAULIC FITTINGS  
ACCESSORIES

# ONE-PIECE COUPLINGS

## TG000 SERIES ONE-PIECE CRIMP COUPLINGS

**JIC**

**TG030**

JIC  
37° CONE MALE

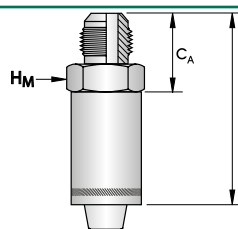

PART NO.	HOSE SIZE		THREAD SIZE	TUBE SIZE	DASH SIZE	DIMENSIONS				SPANNER			
	DN	inch	inch			L		CA		DL		HF	HM
TG030-0207	4	1/8	7/16" -20		-0207	2.01	51	1.10	28				1/2

**JSEAL™ / JIC**

**TG040**

JSEAL™ / JIC FEMALE  
CONVEX SEAT

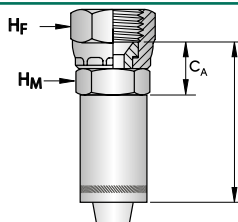

PART NO.	HOSE SIZE		THREAD SIZE	TUBE SIZE	DASH SIZE	DIMENSIONS				SPANNER			
	DN	inch	inch			L		CA		DL		HF	HM
TG040-0207	4	1/8	7/16" -20		-0207	1.77	45	0.87	22			9/16	7/16 11

**STANDPIPE**

**TG640**

METRIC STANDPIPE

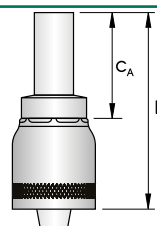

PART NO.	HOSE SIZE		THREAD SIZE	TUBE SIZE	DASH SIZE	DIMENSIONS				SPANNER			
	DN	inch		mm		L		CA		DL		HF	HM
TG640-0206	4	1/8		6	-0206	2.13	54	1.22	31				
TG640-0208	4	1/8		8	-0208	2.13	54	1.22	31				

## TW000 SERIES ONE-PIECE CRIMP COUPLINGS

### BSPP TW4027

BSPP FEMALE O RING  
60° CONE

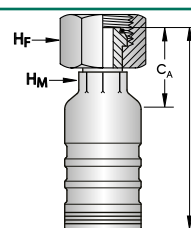

PART NO.	HOSE SIZE		THREAD SIZE	TUBE SIZE	DASH SIZE	DIMENSIONS				SPANNER					
	DN	inch	inch			L		C <sub>A</sub>		D <sub>L</sub>		H <sub>F</sub>		H <sub>M</sub>	
	DN	inch	inch			inch	mm	inch	mm			inch	mm	inch	mm
TW4027-0606	10	3/8	3/8" -19		-0606	3.07	78	1.10	28			7/8	22	11/16	
TW4027-0808	12	1/2	1/2" -14		-0808	3.31	84	1.14	29			1.1/16	27	11/16	
TW4027-1212	19	3/4	3/4" -14		-1212	3.58	91	1.26	32			1.1/4	32	1.1/16	27
TW4027-1616	25	1	1" -11		-1616	3.74	95	1.50	38			1.1/2	38	1.1/4	32

### NPTF TW4090

NPTF MALE  
60° SEAT

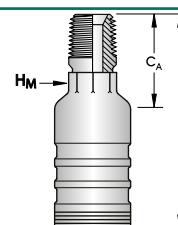

PART NO.	HOSE SIZE		THREAD SIZE	TUBE SIZE	DASH SIZE	DIMENSIONS				SPANNER					
	DN	inch	inch			L		C <sub>A</sub>		D <sub>L</sub>		H <sub>F</sub>		H <sub>M</sub>	
	DN	inch	inch			inch	mm	inch	mm			inch	mm	inch	mm
TW4090-0606	10	3/8	3/8" -18		-0606	3.58	91	1.61	41					11/16	
TW4090-0808	12	1/2	1/2" -14		-0808	4.02	102	1.85	47					7/8	22
TW4090-1212	19	3/4	3/4" -14		-1212	4.29	109	2.01	51					1.1/16	27
TW4090-1616	25	1	1" -11,5		-1616	4.57	116	2.32	59					1.3/8	35

### DKOS TW4711

DKOS FEMALE  
24° CONE

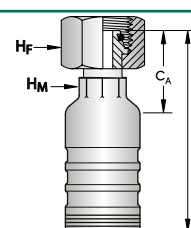

PART NO.	HOSE SIZE		THREAD SIZE	TUBE SIZE	DASH SIZE	DIMENSIONS				SPANNER					
	DN	inch	inch	mm		L		C <sub>A</sub>		D <sub>L</sub>		H <sub>F</sub>		H <sub>M</sub>	
	DN	inch	inch	mm		inch	mm	inch	mm			inch	mm	inch	mm
TW4711-0622	10	3/8	M 22X1,5	14	-0622	3.35	85	1.34	34			1.1/16	27	11/16	
TW4711-0624	10	3/8	M 24X1,5	16	-0624	3.35	85	1.38	35			1.1/4	32	11/16	
TW4711-0824	12	1/2	M 24X1,5	16	-0824	3.58	91	1.42	36			1.1/4	32	11/16	
TW4711-1236	19	3/4	M 36X2	25	-1236	4.06	103	1.77	45				46	1.1/16	27
TW4711-1642	25	1	M 42X2	30	-1642	4.13	105	1.89	48			2	50	1.1/4	32

# PUSH-ON & SUCTION & RETURN COUPLINGS

## 8000 SERIES PUSH-ON COUPLINGS

### HOSE COMPATIBILITY FOR 8000 SERIES

For Ryco Hose Series PL1D.

### BSPP

### 8111

BSPP O RING & RETAINING RING MALE

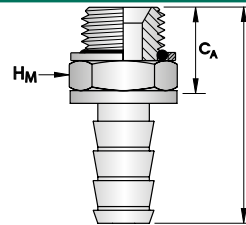

PART NO.	HOSE SIZE		THREAD SIZE	TUBE SIZE	DASH SIZE	DIMENSIONS				SPANNER					
	DN	inch	inch			L		CA		DL		HF		HM	
						inch	mm	inch	mm			inch	mm	inch	mm
8111-1008	16	5/8	1/2" -14		-1008	1.93	49	0.94	24					1.1/16	27

### BSPP

### 8020

BSPP FEMALE  
60° CONE

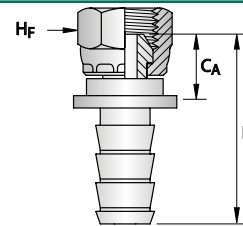

PART NO.	HOSE SIZE		THREAD SIZE	TUBE SIZE	DASH SIZE	DIMENSIONS				SPANNER					
	DN	inch	inch			L		CA		DL		HF		HM	
						inch	mm	inch	mm			inch	mm		
8020-0402	6	1/4	1/8" -28		-0402	1.34	34	0.59	15				14		
8020-0404	6	1/4	1/4" -19		-0404	1.38	35	0.59	15			3/4	19		
8020-0406	6	1/4	3/8" -19		-0406	1.46	37	0.67	17			7/8	22		
8020-0502	8	5/16	1/8" -28		-0502	1.34	34	0.59	15				14		
8020-0504	8	5/16	1/4" -19		-0504	1.38	35	0.59	15			3/4	19		
8020-0606	10	3/8	3/8" -19		-0606	1.54	39	0.67	17			7/8	22		
8020-0608	10	3/8	1/2" -14		-0608	1.61	41	0.75	19			1.1/16	27		
8020-0808	12	1/2	1/2" -14		-0808	1.73	44	0.75	19			1.1/16	27		
8020-1008	16	5/8	1/2" -14		-1008	1.73	44	0.75	19			1.1/16	27		
8020-1212	19	3/4	3/4" -14		-1212	2.17	55	0.75	19			1.1/4	32		

### BSPP

### 8060

BSPP FEMALE  
60° CONE  
45° ELBOW

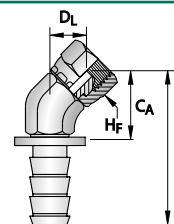

PART NO.	HOSE SIZE		THREAD SIZE	TUBE SIZE	DASH SIZE	DIMENSIONS				SPANNER					
	DN	inch	inch			L		CA		DL		HF		HM	
						inch	mm	inch	mm	inch	mm	inch	mm	inch	mm
8060-1212	19	3/4	3/4" -14		-1212	2.60	66	1.18	30	0.79	20	1.1/4	32	1.1/16	27

## 8000 SERIES PUSH-ON COUPLINGS

### BSPP

### 8050

BSPP FEMALE  
60° CONE  
90° ELBOW

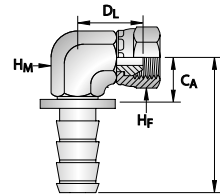

PART NO.	HOSE SIZE		THREAD SIZE	TUBE SIZE	DASH SIZE	DIMENSIONS						SPANNER			
	DN	inch	inch			L		C <sub>A</sub>		D <sub>L</sub>		H <sub>F</sub>		H <sub>M</sub>	
	DN	inch	inch			inch	mm	inch	mm	inch	mm	inch	mm	inch	mm
8050-0404	6	1/4	1/4"-19		-0404	1.30	33	0.51	13	0.94	24	3/4	19	9/16	
8050-0504	8	5/16	1/4"-19		-0504	1.30	33	0.51	13	0.94	24	3/4	19	9/16	
8050-0606	10	3/8	3/8"-19		-0606	1.54	39	0.67	17	1.14	29	7/8	22	3/4	19
8050-0808	12	1/2	1/2"-14		-0808	1.77	45	0.75	19	1.22	31	1.1/16	27	7/8	22
8050-1008	16	5/8	1/2"-14		-1008	1.85	47	0.83	21	1.38	35	1.1/16	27	1.1/16	27
8050-1212	19	3/4	3/4"-14		-1212	2.28	58	0.87	22	1.42	36	1.1/4	32	1.1/16	27

### BSPT

### 8010

BSPT MALE  
60° SEAT

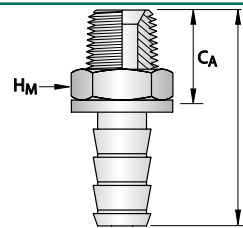

PART NO.	HOSE SIZE		THREAD SIZE	TUBE SIZE	DASH SIZE	DIMENSIONS						SPANNER			
	DN	inch	inch			L		C <sub>A</sub>		D <sub>L</sub>		H <sub>F</sub>		H <sub>M</sub>	
	DN	inch	inch			inch	mm	inch	mm					inch	mm
8010-0402	6	1/4	1/8"-28		-0402	1.46	37	0.71	18						12
8010-0404	6	1/4	1/4"-19		-0404	1.65	42	0.87	22						14
8010-0406	6	1/4	3/8"-19		-0406	1.65	42	0.87	22					3/4	19
8010-0502	8	5/16	1/8"-28		-0502	1.46	37	0.71	18						12
8010-0504	8	5/16	1/4"-19		-0504	1.65	42	0.87	22						14
8010-0506	8	5/16	3/8"-19		-0506	1.65	42	0.87	22					3/4	19
8010-0604	10	3/8	1/4"-19		-0604	1.73	44	0.87	22						14
8010-0606	10	3/8	3/8"-19		-0606	1.73	44	0.87	22					3/4	19
8010-0608	10	3/8	1/2"-14		-0608	2.01	51	1.14	29					7/8	22
8010-0806	12	1/2	3/8"-19		-0806	1.89	48	0.87	22					3/4	19
8010-0808	12	1/2	1/2"-14		-0808	2.13	54	1.14	29					7/8	22
8010-0812	12	1/2	3/4"-14		-0812	2.13	54	1.14	29					1.1/16	27
8010-1008	16	5/8	1/2"-14		-1008	2.13	54	1.14	29					7/8	22
8010-1208	19	3/4	1/2"-14		-1208	2.56	65	1.14	29					15/16	24
8010-1212	19	3/4	3/4"-14		-1212	2.56	65	1.14	29					1.1/16	27

INTRODUCTION

INDEXES

ONE-PIECE COUPLINGS

PUSH-ON SUCTION & RETURN COUPLINGS

FIELD ATTACHABLE COUPLINGS

HYDRAULIC FITTINGS ACCESSORIES

# PUSH-ON & SUCTION & RETURN COUPLINGS

## 8000 SERIES PUSH-ON COUPLINGS

**NPTF**

**8090**

NPTF MALE  
60° SEAT

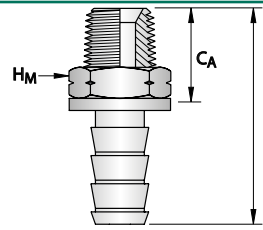

PART NO.	HOSE SIZE		THREAD SIZE	TUBE SIZE	DASH SIZE	DIMENSIONS				SPANNER			
	DN	inch	inch			L		CA		DL	HF	HM	
						inch	mm	inch	mm			inch	mm
8090-0402	6	1/4	1/8" -27		-0402	1.46	37	0.71	18			1/2	
8090-0404	6	1/4	1/4" -18		-0404	1.65	42	0.87	22			9/16	
8090-0502	8	5/16	1/8" -27		-0502	1.46	37	0.71	18			1/2	
8090-0504	8	5/16	1/4" -18		-0504	1.65	42	0.87	22			9/16	
8090-0604	10	3/8	1/4" -18		-0604	1.73	44	0.87	22			9/16	
8090-0606	10	3/8	3/8" -18		-0606	1.73	44	0.87	22			11/16	
8090-0806	12	1/2	3/8" -18		-0806	1.89	48	0.87	22			11/16	
8090-0808	12	1/2	1/2" -14		-0808	2.13	54	1.14	29			7/8	22
8090-1212	19	3/4	3/4" -14		-1212	2.60	66	1.18	30			1.1/16	27

**JIC**

**8030**

JIC  
37° CONE MALE

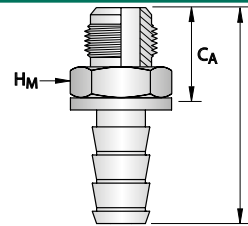

PART NO.	HOSE SIZE		THREAD SIZE	TUBE SIZE	DASH SIZE	DIMENSIONS				SPANNER			
	DN	inch	inch			L		CA		DL	HF	HM	
						inch	mm	inch	mm			inch	mm
8030-0407	6	1/4	7/16" -20		-0407	1.61	41	0.87	22			1/2	
8030-0408	6	1/4	1/2" -20		-0408	1.61	41	0.87	22			1/2	
8030-0508	8	5/16	1/2" -20		-0508	1.61	41	0.87	22			1/2	
8030-0609	10	3/8	9/16" -18		-0609	1.73	44	0.87	22			5/8	16
8030-0612	10	3/8	3/4" -16		-0612	1.81	46	0.94	24			3/4	19
8030-0812	12	1/2	3/4" -16		-0812	1.97	50	0.94	24			3/4	19
8030-0814	12	1/2	7/8" -14		-0814	2.13	54	1.10	28			7/8	22
8030-1014	16	5/8	7/8" -14		-1014	2.13	54	1.10	28			7/8	22
8030-1217	19	3/4	1.1/16" -12		-1217	2.64	67	1.22	31			1.1/8	

## 8000 SERIES PUSH-ON COUPLINGS

### JSEAL™ / JIC

### 8040

JSEAL™ / JIC FEMALE  
CONVEX SEAT

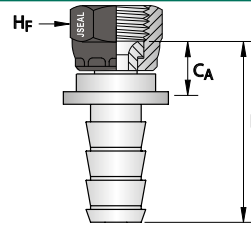

PART NO.	HOSE SIZE		THREAD SIZE	TUBE SIZE	DASH SIZE	DIMENSIONS						SPANNER		
	DN	inch	inch			L		C <sub>A</sub>		D <sub>L</sub>		H <sub>F</sub>		H <sub>M</sub>
						inch	mm	inch	mm			inch	mm	
8040-0407	6	1/4	7/16" -20		-0407	1.30	33	0.51	13			9/16		
8040-0408	6	1/4	1/2" - 20		-0408	1.30	33	0.51	13			5/8	16	
8040-0409	6	1/4	9/16" -18		-0409	1.30	33	0.55	14			11/16		
8040-0508	8	5/16	1/2" - 20		-0508	1.30	33	0.51	13			5/8	16	
8040-0509	8	5/16	9/16" -18		-0509	1.30	33	0.55	14			11/16		
8040-0609	10	3/8	9/16" -18		-0609	1.42	36	0.55	14			11/16		
8040-0612	10	3/8	3/4" -16		-0612	1.46	37	0.59	15			7/8	22	
8040-0812	12	1/2	3/4" -16		-0812	1.61	41	0.59	15			7/8	22	
8040-0814	12	1/2	7/8" -14		-0814	1.73	44	0.75	19			1		
8040-1014	16	5/8	7/8" -14		-1014	1.73	44	0.75	19			1		
8040-1217	19	3/4	1.1/16" -12		-1217	2.20	56	0.79	20			1.1/4	32	

### JSEAL™ / JIC

### 8070

JSEAL™ / JIC FEMALE  
CONVEX SEAT  
90° ELBOW

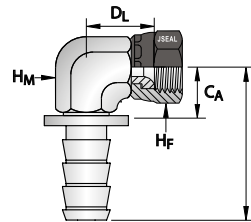

PART NO.	HOSE SIZE		THREAD SIZE	TUBE SIZE	DASH SIZE	DIMENSIONS						SPANNER			
	DN	inch	inch			L		C <sub>A</sub>		D <sub>L</sub>		H <sub>F</sub>		H <sub>M</sub>	
						inch	mm	inch	mm	inch	mm	inch	mm	inch	mm
8070-0407	6	1/4	7/16" -20		-0407	1.38	35	0.59	15	0.71	18	9/16		9/16	
8070-0408	6	1/4	1/2" - 20		-0408	1.30	33	0.51	13	0.67	17	5/8	16	9/16	
8070-0609	10	3/8	9/16" -18		-0609	1.54	39	0.67	17	0.91	23	11/16		3/4	19
8070-0612	10	3/8	3/4" -16		-0612	1.54	39	0.67	17	0.94	24	7/8	22	3/4	19
8070-0812	12	1/2	3/4" -16		-0812	1.77	45	0.75	19	1.06	27	7/8	22	7/8	22
8070-0814	12	1/2	7/8" -14		-0814	1.77	45	0.75	19	1.22	31	1		7/8	22
8070-1217	19	3/4	1.1/16" -12		-1217	2.28	58	0.87	22	1.26	32	1.1/4	32	1.1/16	27

# PUSH-ON & SUCTION & RETURN COUPLINGS

## 8000 SERIES PUSH-ON COUPLINGS

JSEAL™ / JIC

8240

JSEAL™ / JIC FEMALE  
CONVEX SEAT  
90° TUBE BEND

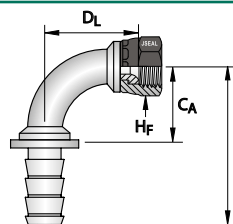

PART NO.	HOSE SIZE		THREAD SIZE	TUBE SIZE	DASH SIZE	DIMENSIONS						SPANNER			
	DN	inch	inch			L		CA		DL		HF		HM	
	DN	inch	inch			inch	mm	inch	mm	inch	mm	inch	mm	inch	mm
8240-0609	10	3/8	9/16" -18		-0609	2.05	52	1.18	30	1.50	38	11/16			
8240-0812	12	1/2	3/4" -16		-0812	2.52	64	1.50	38	1.61	41	7/8	22		
8240-1014	16	5/8	7/8" -14		-1014	2.72	69	1.69	43	1.89	48	1			

JOINER

8900

JOINER

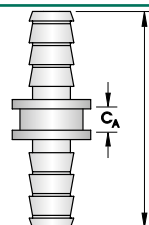

PART NO.	HOSE SIZE		THREAD SIZE	TUBE SIZE	DASH SIZE	DIMENSIONS						SPANNER			
	DN	inch	inch			L		CA		DL		HF		HM	
	DN	inch	inch			inch	mm	inch	mm						
8900-0404	6	1/4			-0404	1.89	48	0.31	8						
8900-0505	8	5/16			-0505	1.89	48	0.31	8						
8900-0606	10	3/8			-0606	2.09	53	0.31	8						
8900-0808	12	1/2			-0808	2.40	61	0.35	9						
8900-1010	16	5/8			-1010	2.24	57	0.20	5						
8900-1212	19	3/4			-1212	3.23	82	0.35	9						

SAE

8530

SAE MALE  
45° CONE

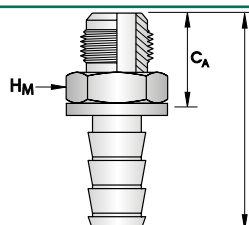

PART NO.	HOSE SIZE		THREAD SIZE	TUBE SIZE	DASH SIZE	DIMENSIONS						SPANNER			
	DN	inch	inch			L		CA		DL		HF		HM	
	DN	inch	inch			inch	mm	inch	mm					inch	mm
8530-0510	8	5/16	5/8" -18		-0510	1.69	43	0.91	23					5/8	16
8530-0610	10	3/8	5/8" -18		-0610	1.77	45	0.91	23					5/8	16
8530-1217	19	3/4	1.1/16" -12		-1217	2.80	71	1.38	35					1.1/16	27

## 8000 SERIES PUSH-ON COUPLINGS

### SAE 8540

SAE FEMALE  
45° FLARE

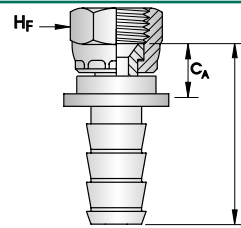

PART NO.	HOSE SIZE		THREAD SIZE	TUBE SIZE	DASH SIZE	DIMENSIONS						SPANNER			
	DN	inch	inch			L		C <sub>A</sub>		D <sub>L</sub>		H <sub>F</sub>		H <sub>M</sub>	
						inch	mm	inch	mm			inch	mm		
8540-0510	8	5/16	5/8" -18		-0510	1.30	33	0.55	14			3/4	19		
8540-0610	10	3/8	5/8" -18		-0610	1.42	36	0.55	14			3/4	19		
8540-1017	16	5/8	1.1/16" -12		-1017	1.69	43	0.67	17			1.1/4	32		
8540-1217	19	3/4	1.1/16" -12		-1217	2.09	53	0.67	17			1.1/4	32		

### SAE 8570

SAE FEMALE  
45° FLARE  
90° ELBOW

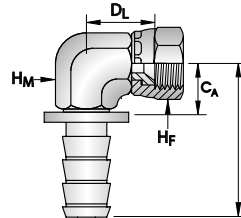

PART NO.	HOSE SIZE		THREAD SIZE	TUBE SIZE	DASH SIZE	DIMENSIONS						SPANNER			
	DN	inch	inch			L		C <sub>A</sub>		D <sub>L</sub>		H <sub>F</sub>		H <sub>M</sub>	
						inch	mm	inch	mm	inch	mm	inch	mm	inch	mm
8570-0610	10	3/8	5/8" -18		-0610	1.54	39	0.67	17	0.91	23	3/4	19	3/4	19

### SAE 8740

SAE INVERTED FLARE  
MALE

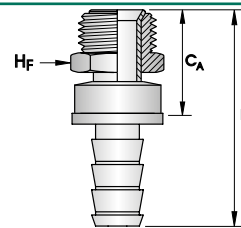

PART NO.	HOSE SIZE		THREAD SIZE	TUBE SIZE	DASH SIZE	DIMENSIONS						SPANNER			
	DN	inch	inch			L		C <sub>A</sub>		D <sub>L</sub>		H <sub>F</sub>		H <sub>M</sub>	
						inch	mm	inch	mm			inch	mm		
8740-0407	6	1/4	7/16" -20		-0407	1.65	42	0.87	22			7/16	11		
8740-0408	6	1/4	1/2" -20		-0408	1.73	44	0.94	24			1/2			
8740-0508	8	5/16	1/2" -20		-0508	1.73	44	0.94	24			1/2			
8740-0510	8	5/16	5/8" -18		-0510	1.85	47	1.06	27			5/8	16		
8740-0610	10	3/8	5/8" -18		-0610	1.93	49	1.06	27			5/8	16		

INTRODUCTION

INDEXES

ONE-PIECE  
COUPLINGS

PUSH-ON SUCTION &  
RETURN COUPLINGS

FIELD ATTACHABLE  
COUPLINGS

HYDRAULIC FITTINGS  
ACCESSORIES

# PUSH-ON & SUCTION & RETURN COUPLINGS

## 8000 SERIES PUSH-ON COUPLINGS

### SALVAGE

### 8230

SALVAGE (LIFESAVER)

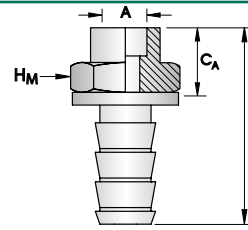

PART NO.	HOSE SIZE		THREAD SIZE	TUBE SIZE	DASH SIZE	DIMENSIONS				SPANNER			
	DN	inch				inch	inch	inch	mm	inch	mm	inch	mm
8230-0406	6	1/4		3/8	-0406	1.34	34	0.55	14			5/8	16
8230-0604	10	3/8		1/4	-0604	1.42	36	0.55	14			1/2	
8230-0606	10	3/8		3/8	-0606	1.42	36	0.55	14			11/16	
8230-0808	12	1/2		1/2	-0808	1.57	40	0.55	14			3/4	19
8230-0810	12	1/2		5/8	-0810	1.65	42	0.63	16			7/8	22
8230-1010	16	5/8		5/8	-1010	1.65	42	0.63	16			7/8	22
8230-1212	19	3/4		3/4	-1212	2.05	52	0.63	16			1.1/16	27

### STANDPIPE

### 8180

IMPERIAL STANDPIPE

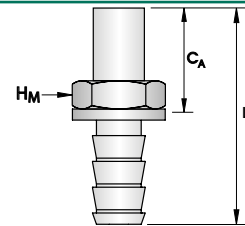

PART NO.	HOSE SIZE		THREAD SIZE	TUBE SIZE	DASH SIZE	DIMENSIONS				SPANNER			
	DN	inch				inch	inch	inch	mm	inch	mm	inch	mm
8180-0404	6	1/4		1/4	-0404	1.93	49	1.18	30			1/2	
8180-0405	6	1/4		5/16	-0405	1.93	49	1.18	30			1/2	
8180-0406	6	1/4		3/8	-0406	1.97	50	1.22	31			1/2	
8180-0606	10	3/8		3/8	-0606	2.09	53	1.22	31			9/16	
8180-0608	10	3/8		1/2	-0608	2.09	53	1.22	31			9/16	
8180-0808	12	1/2		1/2	-0808	2.20	56	1.22	31			11/16	
8180-1212	19	3/4		3/4	-1212	3.19	81	1.77	45			1.1/16	27

### UNO

### 8200

UN O RING MALE  
(O RING BOSS)

O RING SUPPLIED

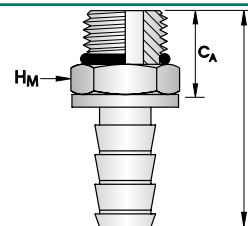

PART NO.	HOSE SIZE		THREAD SIZE	TUBE SIZE	DASH SIZE	DIMENSIONS				SPANNER			
	DN	inch				inch	inch	inch	mm	inch	mm	inch	mm
8200-0812	12	1/2	3/4" -14		-0812	1.81	46	0.79	20			7/8	22

## 8000 SERIES PUSH-ON COUPLINGS

### 200 COUPLING NIPPLE

### 8100

SPECIALS

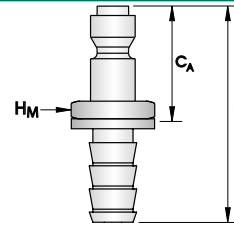

PART NO.	HOSE SIZE		THREAD SIZE	TUBE SIZE	DASH SIZE	DIMENSIONS				SPANNER					
	DN	inch				inch	mm	inch	mm	inch	mm	inch	mm	inch	mm
<b>8100-0404</b>	6	1/4			-0404	1.81	46	1.06	27						
<b>8100-0604</b>	10	3/8			-0604	1.93	49	1.06	27						

### STANDPIPE

### 8640

METRIC STANDPIPE

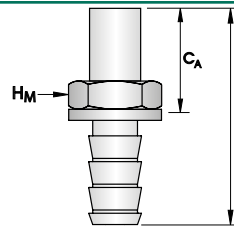

PART NO.	HOSE SIZE		THREAD SIZE	TUBE SIZE	DASH SIZE	DIMENSIONS				SPANNER					
	DN	inch				mm	inch	mm	inch	mm	inch	mm	inch	mm	
<b>8640-0406</b>	6	1/4	6		-0406	1.93	49	1.18	30					1/2	
<b>8640-0408</b>	6	1/4	8		-0408	1.93	49	1.18	30					1/2	
<b>8640-1220</b>	19	3/4	20		-1220	3.27	83	1.85	47					1.1/8	
<b>8640-1222</b>	19	3/4	22		-1222	2.95	75	1.54	39					1.1/8	

INTRODUCTION

INDEXES

ONE-PIECE COUPLINGS

PUSH-ON SUCTION & RETURN COUPLINGS

FIELD ATTACHABLE COUPLINGS

HYDRAULIC FITTINGS ACCESSORIES

# PUSH-ON & SUCTION & RETURN COUPLINGS

## 33000 SERIES SUCTION AND RETURN COUPLINGS

### HOSE COMPATIBILITY FOR 33000 SERIES

For Ryco Hose Series SRX/HT and SRF/P all sizes.  
**33000** Series require a suitable clamp around the outside of the hose.

HOSE DASH SIZE	CLAMP PART NO	CLAMP ADJUSTMENT RANGE	RECOMMENDED TIGHTENING TORQUE	
			Nm	ft. lbs
		d mm		
-12	RSC-3134	31 to 34	20	15
-16	RSC-3740*	37 to 40	20	15
	RSC-4043*	40 to 43	20	15
-20	RSC-4347*	43 to 47	20	15
	RSC-4751*	47 to 51	20	15
-24	RSC-5155	51 to 55	20	15
-32	RSC-6368	63 to 68	25	18
-40	RSC-7379	73 to 79	25	18
-48	RSC-8591	85 to 91	25	18

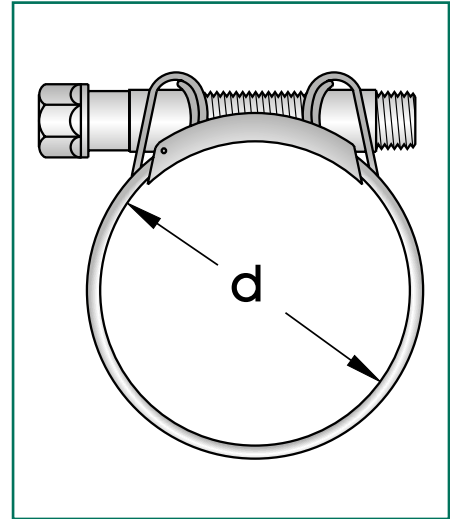

\* Due to the manufacturing tolerance on outside diameter of the hose and the range of adjustment of the clamp, it is necessary to confirm correct clamp at time of assembly.

### BSPP

### 33111

BSPP  
 O RING & RETAINING RING MALE

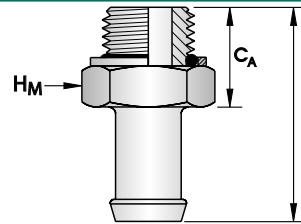

PART NO.	HOSE SIZE		THREAD SIZE	TUBE SIZE	DASH SIZE	DIMENSIONS				SPANNER		
	DN	inch				L	C <sub>A</sub>	D <sub>L</sub>	H <sub>F</sub>	H <sub>M</sub>		
		inch	inch			inch	mm	inch	mm		inch	mm
33111-1612	25	1	3/4" -14		-1612	2.40	61	1.02	26			36
33111-1616	25	1	1" -11		-1616	2.56	65	1.18	30		1.5/8	41
33111-2012	31	1.1/4	3/4" -14		-2012	2.40	61	1.02	26		1.1/2	38
33111-2016	31	1.1/4	1" -11		-2016	2.56	65	1.18	30		1.5/8	41
33111-2020	31	1.1/4	1.1/4" -11		-2020	2.64	67	1.26	32		2	50
33111-2416	38	1.1/2	1" -11		-2416	2.56	65	1.18	30		1.5/8	41
33111-2420	38	1.1/2	1.1/4" -11		-2420	2.64	67	1.26	32		2	50

## 33000 SERIES SUCTION AND RETURN COUPLINGS

**BSPP**

**33410**

**BSPP O RING & RETAINING RING MALE  
90° ELBOW**

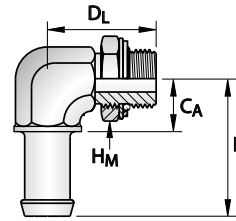

PART NO.	HOSE SIZE		THREAD SIZE	TUBE SIZE	DASH SIZE	DIMENSIONS						SPANNER			
	DN	inch	inch			L		C <sub>A</sub>		D <sub>L</sub>		H <sub>F</sub>		H <sub>M</sub>	
						inch	mm	inch	mm	inch	mm	inch	mm	inch	mm
<b>33410-1608</b>	25	1	1/2" -14		-1608	2.36	60	0.98	25	1.81	46	1		1.1/16	27
<b>33410-1612</b>	25	1	3/4" -14		-1612	2.36	60	0.98	25	1.85	47	1.1/4	32	1.1/16	27
<b>33410-2012</b>	31	1.1/4	3/4" -14		-2012	2.56	65	1.18	30	1.97	50	1.1/4	32	1.5/16	
<b>33410-2016</b>	31	1.1/4	1" -11		-2016	2.56	65	1.18	30	2.05	52	1.1/2	38	1.5/16	
<b>33410-2020</b>	31	1.1/4	1.1/4" -11		-2020	2.80	71	1.42	36	2.24	57	1.43/50		1.5/8	41
<b>33410-2416</b>	38	1.1/2	1" -11		-2416	2.80	71	1.42	36	2.24	57	1.1/2	38	1.5/8	41
<b>33410-2420</b>	38	1.1/2	1.1/4" -11		-2420	2.80	71	1.42	36	2.24	57	1.43/50		1.5/8	41

**BSPP**

**33020**

**BSPP FEMALE  
60° CONE**

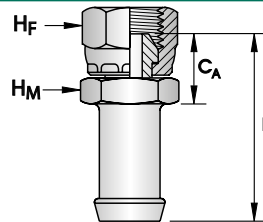

PART NO.	HOSE SIZE		THREAD SIZE	TUBE SIZE	DASH SIZE	DIMENSIONS						SPANNER			
	DN	inch	inch			L		C <sub>A</sub>		D <sub>L</sub>		H <sub>F</sub>		H <sub>M</sub>	
						inch	mm	inch	mm			inch	mm	inch	mm
<b>33020-1212</b>	19	3/4	3/4" -14		-1212	2.32	59	0.94	24			1.1/4	32	1.1/8	
<b>33020-1616</b>	25	1	1" -11		-1616	2.44	62	1.06	27			1.1/2	38	1.3/8	35
<b>33020-2020</b>	31	1.1/4	1.1/4" -11		-2020	2.60	66	1.22	31			2	50	1.3/4	
<b>33020-2424</b>	38	1.1/2	1.1/2" -11		-2424	2.64	67	1.26	32			2.3/16	55	2	50

INTRODUCTION

INDEXES

ONE-PIECE  
COUPLINGS

PUSH-ON SUCTION &  
RETURN COUPLINGS

FIELD ATTACHABLE  
COUPLINGS

HYDRAULIC FITTINGS  
ACCESSORIES

# PUSH-ON & SUCTION & RETURN COUPLINGS

## 33000 SERIES SUCTION AND RETURN COUPLINGS

### BSPP

### 33024

BSPP FEMALE  
FLAT FACE

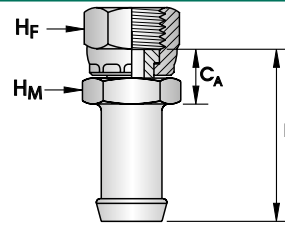

PART NO.	HOSE SIZE		THREAD SIZE	TUBE SIZE	DASH SIZE	DIMENSIONS				SPANNER					
	DN	inch	inch			L		C <sub>A</sub>		D <sub>L</sub>		H <sub>F</sub>		H <sub>M</sub>	
						inch	mm	inch	mm			inch	mm	inch	mm
33024-1212	19	3/4	3/4" -14		-1212	2.32	57	0.84	21				32		
33024-1616	25	1	1" -11		-1616	2.36	60	0.94	24			1.1/2	38	1.3/8	35
33024-2020	31	1.1/4	1.1/4" -11		-2020	2.60	58	0.91	23				50		

### BSPT

### 33010

BSPT MALE  
60° SEAT

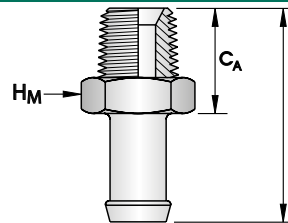

PART NO.	HOSE SIZE		THREAD SIZE	TUBE SIZE	DASH SIZE	DIMENSIONS				SPANNER					
	DN	inch	inch			L		C <sub>A</sub>		D <sub>L</sub>		H <sub>F</sub>		H <sub>M</sub>	
						inch	mm	inch	mm					inch	mm
33010-1206	19	3/4	3/8" -19		-1206	2.28	58	0.91	23					1.1/16	27
33010-1208	19	3/4	1/2" -14		-1208	2.48	63	1.10	28					1.1/16	27
33010-1212	19	3/4	3/4" -14		-1212	2.48	63	1.10	28					1.1/16	27
33010-1216	19	3/4	1" -11		-1216	2.80	71	1.42	36						36
33010-1612	25	1	3/4" -14		-1612	2.52	64	1.14	29					1.1/16	27
33010-1616	25	1	1" -11		-1616	2.80	71	1.42	36						36
33010-1620	25	1	1.1/4" -11		-1620	2.87	73	1.50	38						46
33010-2012	31	1.1/4	3/4" -14		-2012	2.60	66	1.22	31						36
33010-2016	31	1.1/4	1" -11		-2016	2.80	71	1.42	36						36
33010-2020	31	1.1/4	1.1/4" -11		-2020	2.87	73	1.50	38						46
33010-2024	31	1.1/4	1.1/2" -11		-2024	2.91	74	1.54	39					2	50
33010-2416	38	1.1/2	1" -11		-2416	2.80	71	1.42	36					1.5/8	41
33010-2420	38	1.1/2	1.1/4" -11		-2420	2.87	73	1.50	38						46
33010-2424	38	1.1/2	1.1/2" -11		-2424	2.91	74	1.54	39					2	50
33010-3216	51	2	1" -11		-3216	2.91	74	1.54	39					2.3/16	55
33010-3224	51	2	1.1/2" -11		-3224	2.95	75	1.57	40					2.3/16	55
33010-3232	51	2	2" -11		-3232	3.15	80	1.73	44						65

## 33000 SERIES SUCTION AND RETURN COUPLINGS

**BSPT**

**33400**

BSPT MALE  
60° SEAT  
90° ELBOW

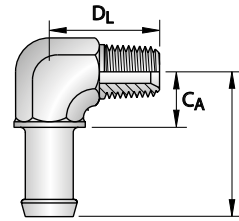

PART NO.	HOSE SIZE		THREAD SIZE	TUBE SIZE	DASH SIZE	DIMENSIONS						SPANNER		
	DN	inch	inch			L		CA		DL		HF	HM	
						inch	mm	inch	mm	inch	mm		inch	mm
33400-1208	19	3/4	1/2" -14		-1208	2.24	57	0.87	22	1.46	37		7/8	22
33400-1212	19	3/4	3/4" -14		-1212	2.36	60	0.98	25	1.57	40		1.1/16	27
33400-1608	25	1	1/2" -14		-1608	2.36	60	0.98	25	1.69	43		1.1/16	27
33400-1612	25	1	3/4" -14		-1612	2.36	60	0.98	25	1.57	40		1.1/16	27
33400-1616	25	1	1" -11		-1616	2.56	65	1.18	30	1.97	50		1.5/16	
33400-1620	25	1	1.1/4" -11		-1620	2.80	71	1.42	36	2.40	61		1.5/8	41
33400-2012	31	1.1/4	3/4" -14		-2012	2.56	65	1.18	30	1.77	45		1.5/16	
33400-2016	31	1.1/4	1" -11		-2016	2.56	65	1.18	30	1.97	50		1.5/16	
33400-2020	31	1.1/4	1.1/4" -11		-2020	2.80	71	1.42	36	2.40	61		1.5/8	41
33400-2024	31	1.1/4	1.1/2" -11		-2024	2.99	76	1.61	41	2.64	67		1.7/8	
33400-2416	38	1.1/2	1" -11		-2416	2.80	71	1.42	36	2.36	60		1.5/8	41
33400-2420	38	1.1/2	1.1/4" -11		-2420	2.80	71	1.42	36	2.36	60		1.5/8	41
33400-2424	38	1.1/2	1.1/2" -11		-2424	2.99	76	1.61	41	2.64	67		1.7/8	
33400-3220	51	2	1.1/4" -11		-3220	3.46	88	2.09	53	2.95	75		2.1/2	
33400-3224	51	2	1.1/2" -11		-3224	3.46	88	2.09	53	2.95	75		2.1/2	

**NPTF**

**33090**

NPTF MALE  
60° SEAT

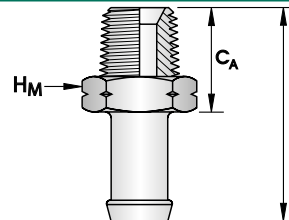

PART NO.	HOSE SIZE		THREAD SIZE	TUBE SIZE	DASH SIZE	DIMENSIONS						SPANNER	
	DN	inch	inch			L		CA		DL	HF	HM	
						inch	mm	inch	mm			inch	mm
33090-1612	25	1	3/4" -14		-1612	2.52	64	1.14	29			1.1/8	
33090-1616	25	1	1" -11,5		-1616	2.80	71	1.42	36			1.3/8	35
33090-2012	31	1.1/4	3/4" -14		-2012	2.60	66	1.22	31			1.3/8	35
33090-2020	31	1.1/4	1.1/4" -11,5		-2020	2.87	73	1.50	38			1.3/4	
33090-2424	38	1.1/2	1.1/2" -11,5		-2424	2.91	74	1.54	39			2	50

# PUSH-ON & SUCTION & RETURN COUPLINGS

## 33000 SERIES SUCTION AND RETURN COUPLINGS

**NPTF**

**33400N**

NPTF MALE  
90° ELBOW

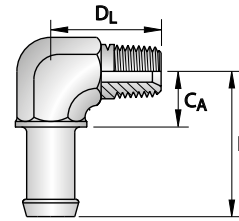

PART NO.	HOSE SIZE		THREAD SIZE	TUBE SIZE	DASH SIZE	DIMENSIONS						SPANNER			
	DN	inch	inch			L		C <sub>A</sub>		D <sub>L</sub>		H <sub>F</sub>		H <sub>M</sub>	
	DN	inch	inch			inch	mm	inch	mm	inch	mm	inch	mm	inch	mm
<b>33400N-1208</b>	19	3/4	1/2" -14		-1208	2.24	57	0.87	22	1.46	37			7/8	22
<b>33400N-1616</b>	25	1	1" -11,5		-1616	2.56	65	1.18	30	1.97	50			1.5/16	

**JSEAL™ / JIC**

**33040**

JSEAL™ / JIC FEMALE  
CONVEX SEAT

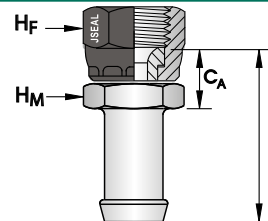

PART NO.	HOSE SIZE		THREAD SIZE	TUBE SIZE	DASH SIZE	DIMENSIONS						SPANNER			
	DN	inch	inch			L		C <sub>A</sub>		D <sub>L</sub>		H <sub>F</sub>		H <sub>M</sub>	
	DN	inch	inch			inch	mm	inch	mm	inch	mm	inch	mm	inch	mm
<b>33040-1617</b>	25	1	1.1/16" -12		-1617	2.36	60	0.94	24			1.1/4	32	1.1/4	32
<b>33040-2026</b>	31	1.1/4	1.5/8" -12		-2026	2.56	65	1.18	30			2	50	1.3/4	

## 33000 SERIES SUCTION AND RETURN COUPLINGS

### DIMENSIONS FOR SAE CODE 61 AND CODE 62 FLANGES, AND RYCO CODE 62C FLANGES

NOMINAL FLANGE	CODE 61				CODE 62				CODE 62C			
	B		T		B		T		B		T	
inch	inch	mm	inch	mm	inch	mm	inch	mm	inch	mm	inch	mm
1/2	30,2	1.19	6,73	0.265	31,8	1.25	7,75	0.305				
5/8	34,0	1.34	6,73	0.265								
3/4	38,1	1.50	6,73	0.265	41,3	1.63	8,76	0.345	41,3	1.63	14,20	0.559
1	44,5	1.75	8,00	0.315	47,6	1.88	9,53	0.375	47,6	1.88	14,20	0.559
1.1/4	50,8	2.00	8,00	0.315	54,0	2.12	10,29	0.405	54,0	2.12	14,20	0.559
1.1/2	60,3	2.38	<b>8,00</b>	<b>0.315</b>	63,5	2.50	12,57	0.495	63,5	2.50	14,20	0.559
2	71,4	2.81	9,53	0.375	79,4	3.13	12,57	0.495	79,4	3.13	14,20	0.559
2.1/2	84,1	3.31	9,53	0.375								
3	101,6	4.00	9,53	0.375								

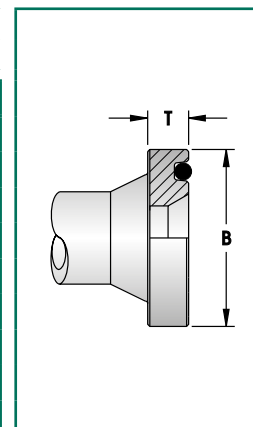

**NOTE:** Ryco Code 62C fittings conform to the flange OD and bolt hole patterns of SAE Code 62 but require special flange clamps. Ryco Code 62C flange heads are thicker than SAE Code 62 and measure T = 14,2 mm (0.559 inch) in all sizes.

### SAE FLANGE

### 33130

#### SAE CODE 61 FLANGE

CLAMPS - SEE PAGES 274 & 282  
O RING NOT SUPPLIED

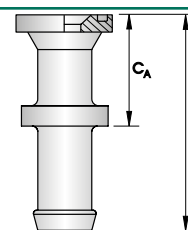

PART NO.	HOSE SIZE		THREAD SIZE	TUBE SIZE	DASH SIZE	DIMENSIONS				SPANNER			
	DN	inch				L		C <sub>A</sub>		D <sub>L</sub>		H <sub>F</sub>	
						inch	mm	inch	mm				
<b>33130-1616</b>	25	1			-1616	3.35	85	1.97	50				
<b>33130-1620</b>	25	1			-1620	3.35	85	1.97	50				
<b>33130-2020</b>	31	1.1/4			-2020	3.31	84	1.93	49				
<b>33130-2024</b>	31	1.1/4			-2024	4.33	110	2.95	75				
<b>33130-2420</b>	38	1.1/2			-2420	3.31	84	1.93	49				
<b>33130-2424</b>	38	1.1/2			-2424	4.33	110	2.95	75				
<b>33130-2432</b>	38	1.1/2			-2432	3.78	96	2.40	61				
<b>33130-3232</b>	51	2			-3232	3.78	96	2.40	61				
<b>33130-3240</b>	51	2			-3240	4.92	125	3.54	90				
<b>33130-4032</b>	63	2.1/2			-4032	4.80	122	2.05	52				

# PUSH-ON & SUCTION & RETURN COUPLINGS

## 33000 SERIES SUCTION AND RETURN COUPLINGS

### SAE FLANGE

### 33150

SAE CODE 61 FLANGE  
45° TUBE BEND

CLAMPS - SEE PAGES 274 & 282  
O RING NOT SUPPLIED

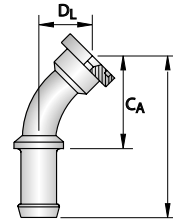

PART NO.	HOSE SIZE		THREAD SIZE	TUBE SIZE	DASH SIZE	DIMENSIONS						SPANNER	
	DN	inch				L		C <sub>A</sub>		D <sub>L</sub>		H <sub>F</sub>	H <sub>M</sub>
						inch	mm	inch	mm	inch	mm		
33150-1616	25	1			-1616	4.37	111	2.99	76	1.34	34		
33150-1620	25	1			-1620	4.37	111	2.99	76	1.34	34		
33150-2020	31	1.1/4			-2020	4.61	117	3.23	82	1.42	36		
33150-2024	31	1.1/4			-2024	4.61	117	3.23	82	1.42	36		
33150-2424	38	1.1/2			-2424	5.00	127	3.62	92	1.50	38		
33150-2432	38	1.1/2			-2432	5.04	128	3.66	93	1.54	39		
33150-3232	51	2			-3232	4.57	116	3.19	81	1.50	38		
33150-3240	51	2			-3240	4.57	116	3.19	81	1.50	38		
33150-4032	63	2.1/2			-4032	6.10	155	3.35	85	1.50	38		

### SAE FLANGE

### 33170

SAE CODE 61 FLANGE  
90° TUBE BEND

CLAMPS - SEE PAGES 274 & 282  
O RING NOT SUPPLIED

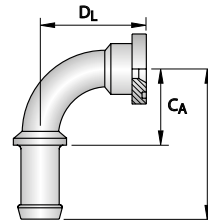

PART NO.	HOSE SIZE		THREAD SIZE	TUBE SIZE	DASH SIZE	DIMENSIONS						SPANNER	
	DN	inch				L		C <sub>A</sub>		D <sub>L</sub>		H <sub>F</sub>	H <sub>M</sub>
						inch	mm	inch	mm	inch	mm		
33170-1616	25	1			-1616	3.90	99	2.52	64	2.76	70		
33170-1620	25	1			-1620	4.61	117	3.23	82	3.66	93		
33170-2016	31	1.1/4			-2016	4.21	107	2.83	72	3.23	82		
33170-2020	31	1.1/4			-2020	4.21	107	2.83	72	3.23	82		
33170-2024	31	1.1/4			-2024	4.21	107	2.83	72	3.23	82		
33170-2424	38	1.1/2			-2424	4.88	124	3.50	89	3.90	99		
33170-2432	38	1.1/2			-2432	4.88	124	3.50	89	3.98	101		
33170-3232	51	2			-3232	5.43	138	4.06	103	4.53	115		
33170-3240	51	2			-3240	5.43	138	4.06	103	4.53	115		
33170-4032	63	2.1/2			-4032	7.01	178	4.25	108	4.53	115		

## 33000 SERIES SUCTION AND RETURN COUPLINGS

<b>UNO</b>	<b>33200</b>
------------	--------------

**UN O RING MALE  
(O RING BOSS)**

O RING SUPPLIED

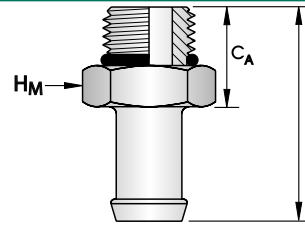

PART NO.	HOSE SIZE		THREAD SIZE	TUBE SIZE	DASH SIZE	DIMENSIONS						SPANNER			
	DN	inch	inch			L		CA		DL		HF		HM	
	DN	inch	inch			inch	mm	inch	mm	inch	mm	inch	mm	inch	mm
<b>33200-1214</b>	19	3/4	7/8" -14		-1214	2.20	56	0.83	21					1	
<b>33200-1217</b>	19	3/4	1.1/16" -12		-1217	2.36	60	0.98	25					1.1/4	32
<b>33200-1221</b>	19	3/4	1.5/16" -12		-1221	1.06	27	2.44	62					1.1/2	38
<b>33200-1617</b>	25	1	1.1/16" -12		-1617	2.36	60	0.98	25					1.1/4	32
<b>33200-1621</b>	25	1	1.5/16" -12		-1621	2.44	62	1.06	27					1.1/2	38
<b>33200-2014</b>	31	1.1/4	7/8" -14		-2014	2.32	59	0.94	24					1.3/8	35
<b>33200-2017</b>	31	1.1/4	1.1/16" -12		-2017	2.44	62	1.06	27					1.3/8	35
<b>33200-2019</b>	31	1.1/4	1.3/16" -12		-2019	2.44	62	1.06	27					1.3/8	35
<b>33200-2021</b>	31	1.1/4	1.5/16" -12		-2021	2.44	62	1.06	27					1.1/2	38
<b>33200-2026</b>	31	1.1/4	1.5/8" -12		-2026	2.48	63	1.10	28					1.43/50	
<b>33200-2417</b>	38	1.1/2	1.1/16" -12		-2417	2.44	62	1.06	27					1.5/8	41
<b>33200-2421</b>	38	1.1/2	1.5/16" -12		-2421	2.44	62	1.06	27					1.5/8	41
<b>33200-2426</b>	38	1.1/2	1.5/8" -12		-2426	2.48	63	1.10	28					1.43/50	
<b>33200-2430</b>	38	1.1/2	1.7/8" -12		-2430	2.56	65	1.18	30					2.1/4	57
<b>33200-3230</b>	51	2	1.7/8" -12		-3230	2.56	65	1.18	30					2.1/4	57

<b>UNO</b>	<b>33420</b>
------------	--------------

**UN O RING MALE  
90° ELBOW**

O RING SUPPLIED

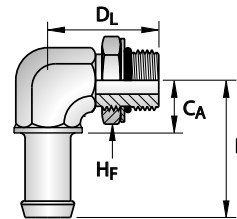

PART NO.	HOSE SIZE		THREAD SIZE	TUBE SIZE	DASH SIZE	DIMENSIONS						SPANNER			
	DN	inch	inch			L		CA		DL		HF		HM	
	DN	inch	inch			inch	mm	inch	mm	inch	mm	inch	mm	inch	mm
<b>33420-1214</b>	19	3/4	7/8" -14		-1214	2.36	60	0.98	25	1.81	46	1		1.1/16	27
<b>33420-1217</b>	19	3/4	1.1/16" -12		-1217	2.56	65	1.18	30	2.05	52	1.1/4	32	1.5/16	
<b>33420-1221</b>	19	3/4	1.5/16" -12		-1221	2.56	65	1.18	30	2.05	52	1.1/2	38	1.5/16	
<b>33420-1617</b>	25	1	1.1/16" -12		-1617	2.56	65	1.18	30	2.05	52	1.1/4	32	1.5/16	
<b>33420-1621</b>	25	1	1.5/16" -12		-1621	2.56	65	1.18	30	2.05	52	1.1/2	38	1.5/16	
<b>33420-2017</b>	31	1.1/4	1.1/16" -12		-2017	2.56	65	1.18	30	2.05	52	1.1/4	32	1.5/16	
<b>33420-2019</b>	31	1.1/4	1.3/16" -12		-2019	2.56	65	1.18	30	2.01	51	1.3/8	35	1.5/16	
<b>33420-2021</b>	31	1.1/4	1.5/16" -12		-2021	2.56	65	1.18	30	2.05	52	1.1/2	38	1.5/16	
<b>33420-2026</b>	31	1.1/4	1.5/8" -12		-2026	2.80	71	1.42	36	2.24	57	1.43/50		1.5/8	41
<b>33420-2421</b>	38	1.1/2	1.5/16" -12		-2421	2.80	71	1.42	36	2.24	57	1.1/2	38	1.5/8	41
<b>33420-2426</b>	38	1.1/2	1.5/8" -12		-2426	2.80	71	1.42	36	2.24	57	1.43/50		1.5/8	41

# FIELD ATTACHABLE COUPLINGS

## V000 SERIES FIELD ATTACHABLE COUPLINGS

### HOSE COMPATIBILITY FOR V000 SERIES

#### FOR RYCO SURVIVOR SURVIVOR/R5 AND TRUCKER T5 HOSE SERIES

Ryco V000 Series Ferrules follow the dash size of **SURVIVOR SURVIVOR/R5** and **TRUCKER T5** series hose. **SURVIVOR/R5** and **T5** Series are SAE 100R5 specification hose, and, accordingly the dash size is the corresponding tube size. SAE 100R5 hose internal diameters (nominal bores), unlike SAE 100R1, R2, etc, are smaller than their dash sizes. For example, **T58** has nominal tube size of 1/2" and internal diameter of 13/32", whereas **T18** and **T28** have nominal bore size of 1/2" and internal diameter of 1/2". The reason for this difference is that T5 Series hoses are often used in applications where hose is connected to steel or copper tubing. The hose is sized so that its flow diameter is approximately the same as the flow diameter of the same nominal size tubing. Hence, the hose size relates to the nominal tube size.

**Ryco V000** Series Ferrules are designed to match with **Ryco 6000** Series Inserts.

**Ryco 6000** Series Inserts have the same nominal sizing as their corresponding **T1** and **T2** Series Hose. Therefore, V000 Series Ferrules and matching 6000 Series Inserts have different "dash" sizes. When matched together, V000 Series Couplings have the same dash size as the 6000 Series Inserts. See table below.

The chart below shows the relationship of Part Numbers for Ferrules, Inserts and Couplings for each size.

SURVIVOR SURVIVOR/R5	TRUCKER T5	HOSE (TUBE) DASH SIZE	HOSE ID INCH	V000 SERIES FERRULE	FERRULE DASH SIZE	6000 SERIES INSERTS	INSERT DASH SIZE	V000 SERIES COUPLINGS	COUPLING DASH SIZE
SURVIVOR/R54	T54	-04	3/16	V000-04	-04	6xxx-03	-03	Vxxx-03	-03
SURVIVOR/R55	T55	-05	1/4	V000-05	-05	6xxx-04	-04	Vxxx-04	-04
SURVIVOR/R56	T56	-06	5/16	V000-06	-06	6xxx-05	-05	Vxxx-05	-05
SURVIVOR/R58	T58	-08	13/32	V000-08	-08	6xxx-06	-06	Vxxx-06	-06
SURVIVOR/R510	T510	-10	1/2	V000-10	-10	6xxx-08	-08	Vxxx-08	-08
SURVIVOR/R512	T512	-12	5/8	V000-12	-12	6xxx-10	-10	Vxxx-10	-10
SURVIVOR/R516	T516	-16	7/8	V000-16	-16	6xxx-14	-14	Vxxx-14	-14
SURVIVOR/R520	T520	-20	1.1/8	V000-20	-20	6xxx-18	-18	Vxxx-18	-18
SURVIVOR/R524	T524	-24	1.3/8	V000-24	-24	6xxx-22	-22	Vxxx-22	-22
SURVIVOR/R532	T532	-32	1.13/16	V000-32	-32	6xxx-29	-29	Vxxx-29	-29

### ADDITIONAL COUPLING END STYLES

Pages 78 to 99 show the T4000 Series Coupling End Styles that are also used with **SURVIVOR/R5** and **T5** hose.

As **Ryco V000** Series Ferrules match with **Ryco 6000** Series Inserts it is possible to use any **Ryco 6000** Insert from -03 to -10 listed in the **6000** Series Field Attachable Inserts with the matching Series Ferrule.

Refer to Ryco for the availability of other **6000** Series Field Attachable Inserts.

### CUT-OFF ALLOWANCE (CA) DIMENSIONS FOR FIELD ATTACHABLES

Due to differences in Ferrule design, many Cut-Off Allowance (CA) dimensions vary between each Ferrule Series for the same matched Insert/Hose size.

The Cut-Off Allowance (CA) dimensions published in "V Series Field Attachable Inserts" section allow for the Ferrule being eased back 5/8 of a turn after the hose has bottomed in the ferrule, as per "Field Attachable Assembly Instructions" (ease back between 1/2 and 3/4 of a turn).

The Cut-Off Allowance (CA) values for **6000** Series Inserts, published in the tables on pages 100 to 130 are for **6000** Series Inserts used with **V000** Series Ferrules. If using V000 Series Ferrules with other matched **6000** Series Inserts listed on pages 218 to 273, contact Ryco Hydraulics Technical Department for the correct Cut-Off Allowance (CA).

If the hose assembly length is critical, when calculating the Cut Length of hose, you must also allow for an increase in length of hose when the coupling is attached, due to compression within the coupling; see page 239.

**NOTE:** Hose Compatibility for the **V000** series can be found on page 238.

## V000 SERIES FIELD ATTACHABLE COUPLINGS

### HOW TO ORDER

**EXAMPLE** To order 1/2" NPT male insert and ferrule for **T58** (13/32") hose.

(a) Individually Order ferrule **V000-08**.  
**V000 Series** ferrules are used on **T5** hose; see chart on page 218,  
 Ferrule Dash Size -08 is same as Dash Size of hose.

Order insert **6090-0608** (6000 Series).  
**T58** hose uses 6000-06 size inserts, see page 218.

(b) Complete Coupling Order **V090-0608**.  
 Simply replace the first character of the insert's part number with the  
 first character of the ferrule's part number.  
 (replace 6 with V): **6090-0608** » **V090-0608**

The **V000 Series** Couplings on pages 220 to page 278 clearly show the Insert, Ferrule and Complete Coupling part numbers for each size of hose.

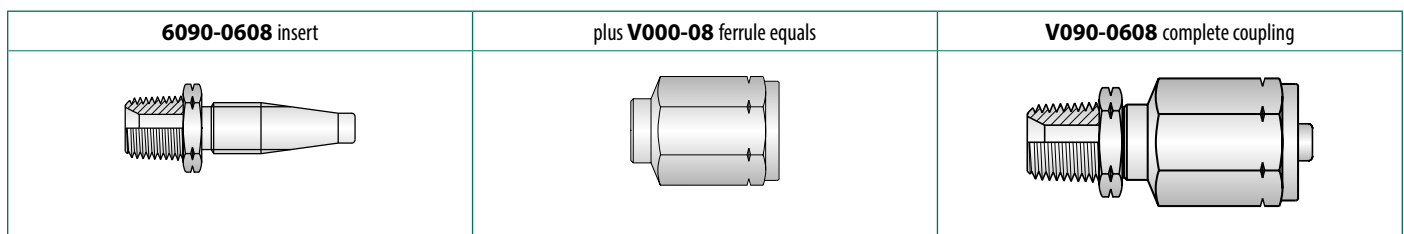

### HOSE BRANDING:

In common with industry practice, **Ryco SURVIVOR/R5** and **T5** hoses are branded with their Part Number, and their Actual Inside Diameter. For example:

<b>RYCO® TRUCKER T55 1/4" MAX WP 3050 PSI•210 BAR MALAYSIA</b> DOT RYCO MMY 1/4 AII • RYCO AIR BRAKE (METRIC SIZE 6.3) SAE J1402 AII
<b>RYCO® TRUCKER T56 5/16" MAX WP 2250 PSI•155 BAR MALAYSIA</b> DOT RYCO MMY 5/16 AII • RYCO AIR BRAKE (METRIC SIZE 8) SAE J1402 AII
<b>RYCO® SURVIVOR/R56 5/16" MAX WP 3050 PSI•210 BAR MALAYSIA</b> DOT RYCO MMY 5/16 AII • RYCO AIR BRAKE (METRIC SIZE 8) SAE J1402 AII
<b>RYCO® SURVIVOR/R56 5/16" MAX WP 3050 PSI•210 BAR MALAYSIA</b> DOT RYCO MMY 5/16 AII • RYCO AIR BRAKE (METRIC SIZE 8) SAE J1402 AII

When ordering hose, it is important to be clear about what size is being referred to.

For example **T55** is -05 or **5/16"** Nominal Dash Size, and **1/4"** Actual Inside Diameter.  
**T56** is -06 or **3/8"** Nominal Dash Size, and **5/16"** Actual Inside Diameter.

Both hoses can be referred to as **5/16"**, depending on whether Nominal or Actual Inside Diameter is being referred to.  
 Other sizes that crossover are:

**T54** and **T55**; **T58** and **T510**; and **T510** and **T512**.  
**SURVIVOR/R54** and **SURVIVOR/R5**; **SURVIVOR/R58** and **SURVIVOR/R510**; and **SURVIVOR/R510** and **SURVIVOR/R512**.

It is **NOT RECOMMENDED** to refer to the size of the hose only, or there may be confusion about whether it is Actual or Nominal Diameter.

It is **RECOMMENDED** to only refer to the Part Number of the hose. Example: **T56**.

If the size is mentioned, the Part Number of the hose must also be included to remove any confusion.

**EXAMPLE: 5/16" T56.**

# FIELD ATTACHABLE COUPLINGS

## V000 SERIES FIELD ATTACHABLE COUPLINGS

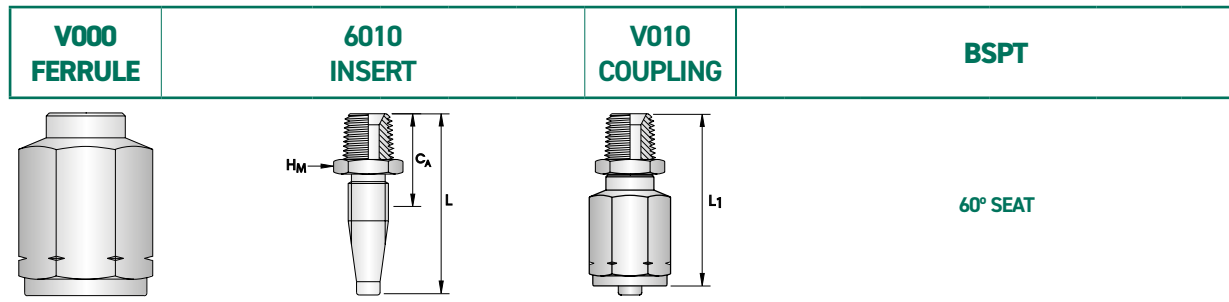

		BSPT MALE				HOSE SIZE ACTUAL ID		THRD SIZE	DASH SIZE	BACK UP AF		
PART NO	PART NO	CA		L		PART NO	DN	inch	inch		AF-SPANNER	
		inch	mm	inch	mm						inch	mm
V000-05	6010-0404	1.38	35	2.44	62	V010-0404	6	1/4	1/4" -19	-0404	5/8	16
V000-05	6010-0406	1.38	35	2.44	62	V010-0406	6	1/4	3/8" -19	-0406	11/16	
V000-06	6010-0504	1.30	33	2.36	60	V010-0504	8	5/16	1/4" -19	-0504	5/8	16
V000-06	6010-0506	1.30	33	2.36	60	V010-0506	8	5/16	3/8" -19	-0506	11/16	
V000-08	6010-0602	1.10	28	2.40	61	V010-0602	10	3/8	1/8" -28	-0602	11/16	
V000-08	6010-0604	1.26	32	2.60	66	V010-0606	10	3/8	1/4" -19	-0604	11/16	
V000-08	6010-0606	1.26	32	2.60	66	V010-0608	10	3/8	3/8" -19	-0606	11/16	
V000-08	6010-0608	1.50	38	2.83	72	V010-0608	10	3/8	1/2" -14	-0608	7/8	22
V000-10	6010-0804	1.46	37	2.76	70	V010-0804	12	1/2	1/4" -19	-0804	13/16	
V000-10	6010-0806	1.46	37	2.76	70	V010-0806	12	1/2	3/8" -19	-0806	13/16	
V000-10	6010-0808	1.65	42	2.91	74	V010-0808	12	1/2	1/2" -14	-0808	7/8	22
V000-12	6010-1008	1.77	45	3.19	81	V010-1008	16	5/8	1/2" -14	-1008	1.1/8	
V000-12	6010-1010	1.77	45	3.19	81	V010-1010	16	5/8	5/8" -14	-1010	1.1/8	
V000-12	6010-1012	1.77	45	3.19	81	V010-1012	16	5/8	3/4" -14	-1012	1.1/8	
	6010-1212	1.65	42	3.15	80	V010-1212	19	3/4	3/4" -14	-1212	1.1/16	27
	6010-1216	1.97	50	3.46	88	V010-1216	19	3/4	1" -11	-1216	1.3/8	35
	6010-1616	2.17	55	3.66	93	V010-1616	25	1	1" -11	-1616	1.3/8	35
V000-20	6010-1820	2.28	58	3.54	90	V010-1820	28	1.1/8	1.1/4" -11	-1820	1.43/50	
	6010-2020	2.36	60	4.49	114	V010-2020	31	1.1/4	1.1/4" -11	-2020	1.43/50	
	6010-2424	2.24	57	4.72	120	V010-2424	38	1.1/2	1.1/2" -11	-2424	2.1/4	57
	6010-3232	2.60	66	5.39	137	V010-3232	51	2	2" -11	-3232	2.1/2	

## V000 SERIES FIELD ATTACHABLE COUPLINGS

V000 FERRULE	6020 INSERT	V020 COUPLING	BSPP											
			60° SEAT											
BSPP FEMALE						HOSE SIZE ACTUAL ID	THRD SIZE	DASH SIZE	BACK UP AF	FEMALE HEX				
PART NO	PART NO	CA		L		PART NO	DN	inch	inch		AF-SPANNER		HF-SPANNER	
		inch	mm	inch	mm						inch	mm	inch	mm
V000-04	6020-0302	0.98	25	1.81	46	V020-0302	5	3/16	1/8" -28	-0302	5/8	16		14
V000-05	6020-0402	1.22	31	2.24	57	V020-0402	6	1/4	1/8" -28	-0402	5/8	16		14
V000-05	6020-0404	1.22	31	2.28	58	V020-0404	6	1/4	1/4" -19	-0404	11/16		3/4	19
V000-05	6020-0406	1.30	33	2.36	60	V020-0406	6	1/4	3/8" -19	-0406	11/16		7/8	22
V000-06	6020-0504	1.14	29	2.20	56	V020-0504	8	5/16	1/4" -19	-0504	5/8	16	3/4	19
V000-06	6020-0506	1.30	33	2.36	60	V020-0506	8	5/16	3/8" -19	-0506	11/16		7/8	22
V000-08	6020-0604	1.10	28	2.40	61	V020-0604	10	3/8	1/4" -19	-0604	11/16		3/4	19
V000-08	6020-0606	1.22	31	2.56	65	V020-0606	10	3/8	3/8" -19	-0606	13/16		7/8	22
V000-08	6020-0608	1.30	33	2.60	66	V020-0608	10	3/8	1/2" -14	-0608	7/8	22	1.1/16	27
V000-10	6020-0806	1.34	34	2.64	67	V020-0806	12	1/2	3/8" -19	-0806	13/16		7/8	22
V000-10	6020-0808	1.42	36	2.72	69	V020-0808	12	1/2	1/2" -14	-0808	1		1.1/16	27
	6020-0812	1.42	36	2.72	69	V020-0812	12	1/2	3/4" -14	-0812	1		1.1/4	32
V000-12	6020-1010	1.50	38	2.91	74	V020-1010	16	5/8	5/8" -14	-1010	1.1/8		1.3/16	30
V000-12	6020-1012	1.57	40	2.99	76	V020-1012	16	5/8	3/4" -14	-1012	1.1/8		1.1/4	32
	6020-1212	1.50	38	2.99	76	V020-1212	19	3/4	3/4" -14	-1212	1.1/4	32	1.1/4	32
	6020-1216	1.65	42	3.11	79	V020-1216	19	3/4	1" -11	-1216	1.1/2	38	1.1/2	38
	6020-1416	1.57	40	2.64	67	V020-1416	22	7/8	1" -11	-1416	1.1/2	38	1.1/2	38
	6020-1616	1.81	46	3.35	85	V020-1616	25	1	1" -11	-1616	1.1/2	38	1.1/2	38
V000-20	6020-1820	2.01	51	3.31	84	V020-1820	28	1.1/8	1.1/4" -11	-1820	1.43/50		2	50
	6020-2020	2.13	54	4.21	107	V020-2020	31	1.1/4	1.1/4" -11	-2020	1.43/50		2	50
	6020-2424	2.01	51	4.49	114	V020-2424	38	1.1/2	1.1/2" -11	-2424	2.1/4	57	2.3/16	55
	6020-3232	2.44	62	5.24	133	V020-3232	51	2	2" -11	-3232	2.3/4	70	2.3/4	70

INTRODUCTION

INDEXES

ONE-PIECE COUPLINGS

PUSH-ON SUCTION & RETURN COUPLINGS

FIELD ATTACHABLE COUPLINGS

HYDRAULIC FITTINGS ACCESSORIES

# FIELD ATTACHABLE COUPLINGS

## V000 SERIES FIELD ATTACHABLE COUPLINGS

<b>V000 FERRULE</b>	<b>6270 INSERT</b>	<b>V270 COUPLING</b>	<b>BSPP</b>
---------------------	--------------------	----------------------	-------------

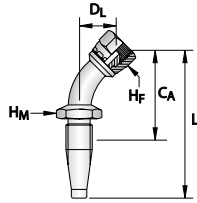
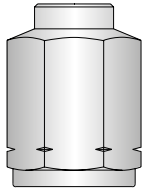

60° SEAT

		BSPP FEMALE 45° TUBE BEND						HOSE SIZE ACTUAL ID		THRD SIZE	DASH SIZE	BACK UP AF	FEMALE HEX			
PART NO	PART NO	CA		L		DL		PART NO	DN	inch	inch		AF-SPANNER		HF-SPANNER	
		inch	mm	inch	mm	inch	mm						inch	mm	inch	mm
V000-05	6270-0404	1.85	47	2.87	73	0.67	17	V270-0404	6	1/4	1/4" -19	-0404	5/8	16	3/4	19
V000-06	6270-0506	2.09	53	3.19	81	0.75	19	V270-0506	8	5/16	3/8" -19	-0506	5/8	16	7/8	22
V000-08	6270-0606	2.05	52	3.35	85	0.71	18	V270-0606	10	3/8	3/8" -19	-0606	11/16		7/8	22
V000-10	6270-0808	2.44	62	3.74	95	0.87	22	V270-0808	12	1/2	1/2" -14	-0808	13/16		1.1/16	27
V000-12	6270-1010	2.72	69	4.13	105	0.91	23	V270-1010	16	5/8	5/8" -14	-1010	1		1.3/16	30
	6270-1212	3.23	82	4.69	119	1.14	29	V270-1212	19	3/4	3/4" -14	-1212	1.1/16	27	1.1/4	32
	6270-1616	4.25	108	5.79	147	1.54	39	V270-1616	25	1	1" -11	-1616	1.3/8		1.1/2	38
	6270-2020	4.80	122	6.93	176	1.73	44	V270-2020	31	1.1/4	1.1/4" -11	-2020	1.3/4		2	50
	6270-2224	5.16	131	6.46	164	2.05	52	V270-2224	35	1.3/8	1.1/2" -11	-2224	2		2.3/16	55
	6270-3232	6.50	165	9.29	236	2.56	65	V270-3232	51	2	2" -11	-3232	2.1/2		2.3/4	70

<b>V000 FERRULE</b>	<b>6260 INSERT</b>	<b>V260 COUPLING</b>	<b>BSPP</b>
---------------------	--------------------	----------------------	-------------

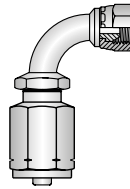
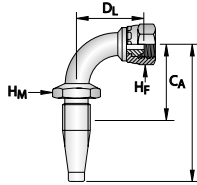
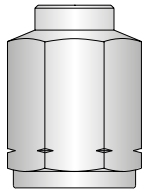

60° SEAT

		BSPP FEMALE 90° TUBE BEND						HOSE SIZE ACTUAL ID		THRD SIZE	DASH SIZE	BACK UP AF	FEMALE HEX			
PART NO	PART NO	CA		L		DL		PART NO	DN	inch	inch		AF-SPANNER		HF-SPANNER	
		inch	mm	inch	mm	inch	mm						inch	mm	inch	mm
V000-05	6260-0404	1.54	39	2.60	66	1.14	29	V260-0404	6	1/4	1/4" -19	-0404	5/8	16	3/4	19
V000-06	6260-0506	1.73	44	2.80	71	1.34	34	V260-0506	8	5/16	3/8" -19	-0506	5/8	16	7/8	22
V000-08	6260-0606	1.73	44	3.03	77	1.30	33	V260-0606	10	3/8	3/8" -19	-0606	11/16		7/8	22
V000-08	6260-0608	1.73	44	3.03	77	1.30	33	V260-0608	10	3/8	1/2" -14	-0608	3/4	19	1.1/16	27
V000-10	6260-0808	2.09	53	3.39	86	1.69	43	V260-0808	12	1/2	1/2" -14	-0808	13/16		1.1/16	27
V000-10	6260-0810	2.13	54	3.43	87	1.89	48	V260-0810	12	1/2	5/8" -14	-0810	13/16		1.3/16	30
V000-12	6260-1010	2.48	63	3.90	99	2.01	51	V260-1010	16	5/8	5/8" -14	-1010	1		1.3/16	30
	6260-1212	2.68	68	4.13	105	2.28	58	V260-1212	19	3/4	3/4" -14	-1212	1.1/16	27	1.1/4	32
	6260-1616	3.27	83	4.80	122	2.87	73	V260-1616	25	1	1" -11	-1616	1.3/8		1.1/2	38
	6260-2020	4.17	106	6.30	160	3.46	88	V260-2020	31	1.1/4	1.1/4" -11	-2020	1.3/4		2	50
V000-24	6260-2224	4.45	113	5.75	146	4.17	106	V260-2224	35	1.3/8	1.1/2" -11	-2224	2		2.3/16	55
	6260-3232	5.98	152	8.74	222	5.20	132	V260-3232	51	2	2" -11	-3232	2.1/2		2.3/4	70

## V000 SERIES FIELD ATTACHABLE COUPLINGS

V000 FERRULE	6090 INSERT	V090 COUPLING	NPT
--------------	-------------	---------------	-----

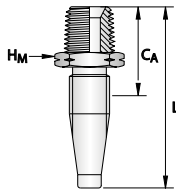
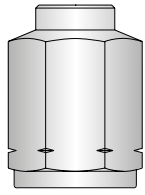

60° SEAT

PART NO	PART NO	NPT MALE		L	PART NO	HOSE SIZE ACTUAL ID		THRD SIZE	DASH SIZE	BACK UP AF	AF-SPANNER	
		inch	mm			inch	mm				DN	inch
V000-04	6090-0302	0.98	25	1.81	46	V090-0302	5	3/16	1/8" -27	-0302	7/16	11
V000-04	6090-0304	1.18	30	1.97	50	V090-0304	5	3/16	1/4" -18	-0304	5/8	16
V000-05	6090-0402	1.22	31	2.24	57	V090-0402	6	1/4	1/8" -27	-0402	7/16	11
V000-05	6090-0404	1.38	35	2.44	62	V090-0404	6	1/4	1/4" -18	-0404	5/8	16
V000-05	6090-0406	1.38	35	2.44	62	V090-0406	6	1/4	3/8" -18	-0406	11/16	
V000-06	6090-0504	1.30	33	2.36	60	V090-0504	8	5/16	1/4" -18	-0504	5/8	16
V000-06	6090-0506	1.38	35	2.44	62	V090-0506	8	5/16	3/8" -18	-0506	11/16	
V000-08	6090-0604	1.26	32	2.60	66	V090-0604	10	3/8	1/4" -18	-0604	11/16	
V000-08	6090-0606	1.26	32	2.60	66	V090-0606	10	3/8	3/8" -18	-0606	11/16	
V000-08	6090-0608	1.50	38	2.83	72	V090-0608	10	3/8	1/2" -14	-0608	7/8	22
V000-10	6090-0806	1.46	37	2.76	70	V090-0806	12	1/2	3/8" -18	-0806	7/8	22
V000-10	6090-0808	1.65	42	2.91	74	V090-0808	12	1/2	1/2" -14	-0808	7/8	22
V000-12	6090-1008	1.77	45	3.19	81	V090-1008	16	5/8	1/2" -14	-1008	1.1/8	
V000-12	6090-1012	1.77	45	3.19	81	V090-1012	16	5/8	3/4" -14	-1012	1.1/8	
	6090-1208	1.65	42	3.15	80	V090-1208	19	3/4	1/2" -14	-1208	1.1/8	
	6090-1212	1.65	42	3.15	80	V090-1212	19	3/4	3/4" -14	-1212	1.1/16	27
	6090-1416	1.89	48	2.99	76	V090-1416	22	7/8	1" -11,5	-1416	1.3/8	35
	6090-1616	2.17	55	3.66	93	V090-1616	25	1	1" -11,5	-1616	1.3/8	35
	6090-1820	2.28	58	3.54	90	V090-1820	28	1.1/8	1.1/4" -11,5	-1820	1.43/50	
	6090-2020	2.36	60	4.49	114	V090-2020	31	1.1/4	1.1/4" -11,5	-2020	1.43/50	
V000-24	6090-2224	2.01	51	3.35	85	V090-2224	35	1.3/8	1.1/2" -11,5	-2224	2	50
	6090-2424	2.24	57	4.72	120	V090-2424	38	1.1/2	1.1/2" -11,5	-2424	2.1/4	57
	6090-3232	2.60	66	5.39	137	V090-3232	51	2	2" -11,5	-3232	2.1/2	

INTRODUCTION

INDEXES

ONE-PIECE COUPLINGS

PUSH-ON SUCTION & RETURN COUPLINGS

FIELD ATTACHABLE COUPLINGS

HYDRAULIC FITTINGS ACCESSORIES

# FIELD ATTACHABLE COUPLINGS

## V000 SERIES FIELD ATTACHABLE COUPLINGS

<b>V000 FERRULE</b>	<b>6030 INSERT</b>	<b>V030 COUPLING</b>	<b>JIC - MALE</b>
---------------------	--------------------	----------------------	-------------------

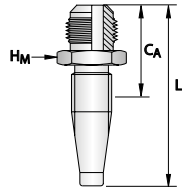
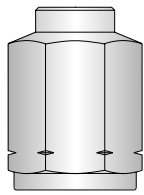

37° FLARE

PART NO	PART NO	JIC MALE				PART NO	HOSE SIZE ACTUAL ID		THRD SIZE	DASH SIZE	BACK UP AF	
		CA	L		DN		inch	inch			inch	mm
V000-04	6030-0307	1.14	29	1.97	50	V030-0307	5	3/16	7/16" -20	-0307	5/8	16
V000-05	6030-0407	1.38	35	2.40	61	V030-0407	6	1/4	7/16" -20	-0407	5/8	16
V000-05	6030-0408	1.38	35	2.40	61	V030-0408	6	1/4	1/2" -20	-0408	5/8	16
V000-05	6030-0409	1.38	35	2.44	62	V030-0409	6	1/4	9/16" -18	-0409	5/8	16
V000-05	6030-0412	1.54	39	2.60	66	V030-0412	6	1/4	3/4" -16	-0412	13/16	
V000-08	6030-0609	1.26	32	2.56	65	V030-0609	10	3/8	9/16" -18	-0609	11/16	
V000-08	6030-0612	1.42	36	2.72	69	V030-0612	10	3/8	3/4" -16	-0612	13/16	
V000-08	6030-0614	1.50	38	2.83	72	V030-0614	10	3/8	7/8" -14	-0614	1	
V000-10	6030-0812	1.54	39	2.83	72	V030-0812	12	1/2	3/4" -16	-0812	13/16	
V000-10	6030-0814	1.61	41	2.91	74	V030-0814	12	1/2	7/8" -14	-0814	15/16	24
V000-10	6030-0817	1.81	46	3.07	78	V030-0817	12	1/2	1.1/16" -12	-0817	1.1/8	
V000-12	6030-1014	1.77	45	3.19	81	V030-1014	16	5/8	7/8" -14	-1014	1.1/8	
V000-12	6030-1017	1.89	48	3.31	84	V030-1017	16	5/8	1.1/16" -12	-1017	1.1/8	
	6030-1217	1.81	46	3.31	84	V030-1217	19	3/4	1.1/16" -12	-1217	1.1/8	
	6030-1219	1.85	47	3.31	84	V030-1219	19	3/4	1.3/16" -12	-1219	1.1/4	32
	6030-1221	1.93	49	3.43	87	V030-1221	19	3/4	1.5/16" -12	-1221	1.3/8	35
	6030-1617	2.05	52	3.58	91	V030-1617	25	1	1.1/16" -12	-1617	1.3/8	35
	6030-1621	2.09	53	3.62	92	V030-1621	25	1	1.5/16" -12	-1621	1.3/8	35
	6030-2026	2.36	60	4.49	114	V030-2026	31	1.1/4	1.5/8" -12	-2026	1.43/50	

## V000 SERIES FIELD ATTACHABLE COUPLINGS

V000 FERRULE	6040 INSERT	V040 COUPLING	JSEAL™ / JIC
--------------	-------------	---------------	--------------

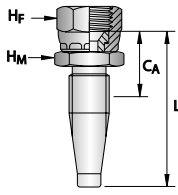
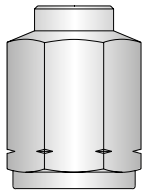

CONVEX SEAT

		JSEAL™ / JIC FEMALE				HOSE SIZE ACTUAL ID		THRD SIZE	DASH SIZE	BACK UP Af	FEMALE HEX			
PART NO	PART NO	CA		L		PART NO	DN	inch	inch	AF-SPANNER	HF-SPANNER			
		inch	mm	inch	mm						inch	mm		
V000-04	6040-0307	0.91	23	1.73	44	V040-0307	5	3/16	7/16" -20	-0307	9/16	9/16		
V000-04	6040-0406	1.26	32	2.28	58	V040-0406	6	1/4	3/8" - 24	-0406	1/2	1/2		
V000-05	6040-0407	1.14	29	2.17	55	V040-0407	6	1/4	7/16" -20	-0407	5/8	16	9/16	
V000-05	6040-0408	1.14	29	2.20	56	V040-0408	6	1/4	1/2" - 20	-0408	5/8	16	5/8	16
V000-05	6040-0409	1.14	29	2.20	56	V040-0409	6	1/4	9/16" -18	-0409	11/16		11/16	
V000-05	6040-0412	1.22	31	2.24	57	V040-0412	6	1/4	3/4" -16	-0412	3/4	19	7/8	22
V000-06	6040-0509	1.06	27	2.13	54	V040-0509	8	5/16	9/16" -18	-0509	11/16		11/16	
V000-08	6040-0607	1.02	26	2.32	59	V040-0607	10	3/8	7/16" -20	-0607	11/16		9/16	
V000-08	6040-0608	1.02	26	2.32	59	V040-0608	10	3/8	1/2" - 20	-0608	11/16		5/8	16
V000-08	6040-0609	0.87	22	2.17	55	V040-0609	10	3/8	9/16" -18	-0609	11/16		11/16	
V000-08	6040-0612	1.14	29	2.44	62	V040-0612	10	3/8	3/4" -16	-0612	7/8	22	7/8	22
V000-08	6040-0614	1.30	33	2.60	66	V040-0614	10	3/8	7/8" -14	-0614	1		1.1/16	27
V000-10	6040-0809	1.22	31	2.52	64	V040-0809	12	1/2	9/16" -18	-0809	13/16		11/16	
V000-10	6040-0812	1.26	32	2.56	65	V040-0812	12	1/2	3/4" -16	-0812	7/8	22	7/8	22
V000-12	6040-0814	1.54	39	2.80	71	V040-0814	12	1/2	7/8" -14	-0814	1		1.1/16	27
V000-10	6040-0817	1.50	38	2.80	71	V040-0817	12	1/2	1.1/16" -12	-0817	1.1/8		1.1/4	32
V000-12	6040-1014	1.50	38	2.91	74	V040-1014	16	5/8	7/8" -14	-1014	1		1.1/16	27
V000-12	6040-1017	1.57	40	2.99	76	V040-1017	16	5/8	1.1/16" -12	-1017	1.1/4	32	1.1/4	32
	6040-1214	1.50	38	2.95	75	V040-1214	19	3/4	7/8" -14	-1214	1.1/16	27	1.1/16	27
	6040-1217	1.54	39	2.99	76	V040-1217	19	3/4	1.1/16" -12	-1217	1.1/4	32	1.1/4	32
	6040-1219	1.50	38	2.99	76	V040-1219	19	3/4	1.3/16" -12	-1219	1.3/8	35	1.3/8	
	6040-1221	1.65	42	3.11	79	V040-1221	19	3/4	1.5/16" -12	-1221	1.1/2	38	1.1/2	38
V000-16	6040-1421	1.57	40	2.64	67	V040-1421	22	7/8	1.5/16" -12	-1421	1.1/2	38	1.1/2	38
	6040-1617	1.77	45	3.31	84	V040-1617	25	1	1.1/16" -12	-1617	1.3/8	35	1.1/4	32
	6040-1621	1.81	46	3.35	85	V040-1621	25	1	1.5/16" -12	-1621	1.1/2	38	1.1/2	38
	6040-1626	1.85	47	3.39	86	V040-1626	25	1	1.5/8" -12	-1626	1.5/8	41	2	50
V000-20	6040-1826	2.13	54	3.39	86	V040-1826	28	1.1/8	1.5/8" -12	-1826	1.43/50		2	50
	6040-2026	2.05	52	4.17	106	V040-2026	31	1.1/4	1.5/8" -12	-2026	1.43/50		2	50
V000-24	6040-2230	1.77	45	3.07	78	V040-2230	35	1.3/8	1.7/8" -12	-2230	2	50	2.1/4	57.15
	6040-2430	2.01	51	4.45	113	V040-2430	38	1.1/2	1.7/8" -12	-2430	2.1/4	57	2.1/4	57.15
V000-32	6040-2940	2.13	54	3.90	99	V040-2940	46	1.13/16	2.1/2" -12	-2940	2.3/4	70	2.7/8	73
	6040-3240	2.44	62	5.24	133	V040-3240	51	2	2.1/2" -12	-3240	2.3/4	70	2.7/8	73

**NOTE:** Hose Compatibility for the V000 series can be found on page 238.

# FIELD ATTACHABLE COUPLINGS

## V000 SERIES FIELD ATTACHABLE COUPLINGS

V000 FERRULE	6070 INSERT	V070 COUPLING	JSEAL™ / JIC
--------------	-------------	---------------	--------------

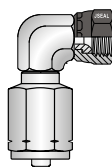
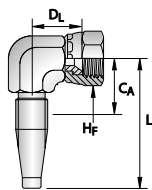
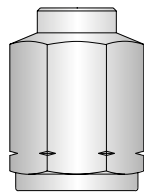

CONVEX SEAT

		JSEAL™ / JIC FEMALE 90° ELBOW						HOSE SIZE ACTUAL ID		THRD SIZE	DASH SIZE	FEMALE HEX		
PART NO	PART NO	CA		L		DL		DN	inch	inch		HF-SPANNER		
		inch	mm	inch	mm	inch	mm					inch	mm	
V000-05	6070-0407	1.02	26	2.09	53	0.71	18	V070-0407	6	1/4	7/16" -20	-0407	9/16	
V000-05	6070-0408	1.02	26	2.09	53	0.67	17	V070-0408	6	1/4	1/2" - 20	-0408	5/8	16
V000-05	6070-0409	1.02	26	2.09	53	0.87	22	V070-0409	6	1/4	9/16" -18	-0409	11/16	
V000-08	6070-0607	0.98	25	2.28	58	0.91	23	V070-0607	10	3/8	7/16" -20	-0607	9/16	
V000-08	6070-0609	0.98	25	2.28	58	0.91	23	V070-0609	10	3/8	9/16" -18	-0609	11/16	
V000-08	6070-0612	0.98	25	2.28	58	0.94	24	V070-0612	10	3/8	3/4" -16	-0612	7/8	22
V000-10	6070-0812	1.26	32	2.56	65	1.06	27	V070-0812	12	1/2	3/4" -16	-0812	7/8	22
V000-10	6070-0814	1.26	32	2.56	65	1.10	28	V070-0814	12	1/2	7/8" -14	-0814	1.1/16	27
V000-10	6070-0817	1.26	32	2.56	65	1.22	31	V070-0817	12	1/2	1.1/16" -12	-0817	1.1/4	32
V000-12	6070-1014	1.34	34	2.80	71	1.26	32	V070-1014	16	5/8	7/8" -14	-1014	1.1/16	27
V000-12	6070-1017	1.30	33	2.72	69	1.26	32	V070-1017	16	5/8	1.1/16" -12	-1017	1.1/4	32
	6070-1217	1.26	32	2.72	69	1.26	32	V070-1217	19	3/4	1.1/16" -12	-1217	1.1/4	32
	6070-1219	1.46	37	2.91	74	1.38	35	V070-1219	19	3/4	1.3/16" -12	-1219	1.3/8	
	6070-1621	1.61	41	3.15	80	1.50	38	V070-1621	25	1	1.5/16" -12	-1621	1.1/2	38
	6070-2026	2.36	60	4.49	114	1.85	47	V070-2026	31	1.1/4	1.5/8" -12	-2026	2	50

**NOTE:** Hose Compatibility for the V000 series can be found on page 238.

## V000 SERIES FIELD ATTACHABLE COUPLINGS

<b>V000 FERRULE</b>	<b>6250 INSERT</b>	<b>V250 COUPLING</b>	<b>JSEAL™ / JIC</b>
---------------------	--------------------	----------------------	---------------------

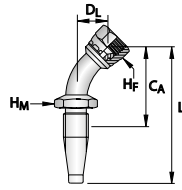
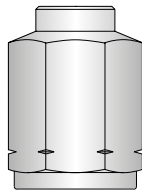

CONVEX SEAT

		JSEAL™ / JIC FEMALE 45° TUBE BEND						HOSE SIZE ACTUAL ID		THRD SIZE	DASH SIZE	BACK UP A <sub>F</sub>	FEMALE HEX			
PART NO	PART NO	CA		L		DL		DN	inch	inch		A <sub>F</sub> -SPANNER		H <sub>F</sub> -SPANNER		
		inch	mm	inch	mm	inch	mm					inch	mm	inch	mm	
V000-04	6250-0307	1.61	41	2.44	62	0.59	15	V250-0307	5	3/16	7/16" -20	-0307	5/8	16	9/16	
V000-05	6250-0407	1.77	45	2.83	72	0.59	15	V250-0407	6	1/4	7/16" -20	-0407	5/8	16	9/16	
V000-05	6250-0408	1.77	45	2.83	72	0.59	15	V250-0408	6	1/4	1/2" -20	-0408	5/8	16	5/8	16
V000-05	6250-0409	1.77	45	2.83	72	0.59	15	V250-0409	6	1/4	9/16" -18	-0409	5/8	16	11/16	
V000-06	6250-0509	1.85	47	2.95	75	0.55	14	V250-0509	8	5/16	9/16" -18	-0509	5/8	16	11/16	
V000-08	6250-0609	1.85	47	3.15	80	0.55	14	V250-0609	10	3/8	9/16" -18	-0609	11/16		11/16	
V000-08	6250-0612	1.89	48	3.19	81	0.67	17	V250-0612	10	3/8	3/4" -16	-0612	11/16		7/8	22
V000-10	6250-0812	2.32	59	3.62	92	0.83	21	V250-0812	12	1/2	3/4" -16	-0812	13/16		7/8	22
V000-10	6250-0814	2.40	61	3.70	94	0.87	22	V250-0814	12	1/2	7/8" -14	-0814	13/16		1	
V000-12	6250-1014	2.68	68	4.09	104	0.94	24	V250-1017	16	5/8	7/8" -14	-1014	1		1	
V000-16	6250-1017	2.68	68	4.09	104	0.94	24	V250-1421	16	5/8	1.1/16" -12	-1017	1		1.1/4	32
V000-24	6250-1217	3.27	83	4.72	120	1.10	28	V250-2230	19	3/4	1.1/16" -12	-1217	1.1/16	27	1.1/4	32
	6250-1219	2.99	76	4.49	114	0.94	24		19	3/4	1.3/16" -12	-1219			1.3/8	35
	6250-1221	3.31	84	4.76	121	1.26	32		19	3/4	1.5/16" -12	-1221	1.1/4	32	1.1/2	38
	6250-1421	3.70	94	4.76	121	1.38	35		22	7/8	1.5/16" -12	-1421	1.3/8	35	1.1/2	38
	6250-1621	3.94	100	5.47	139	1.38	35		25	1	1.5/16" -12	-1621	1.3/8	35	1.1/2	38
	6250-2026	4.69	119	6.81	173	1.54	39		31	1.1/4	1.5/8" -12	-2026	1.3/4		2	50
	6250-2230	5.16	131	6.46	164	1.97	50		35	1.3/8	1.7/8" -12	-2230	2	50	2.1/4	57

INTRODUCTION

INDEXES

ONE-PIECE  
COUPLINGS

PUSH-ON SUCTION &  
RETURN COUPLINGS

FIELD ATTACHABLE  
COUPLINGS

HYDRAULIC FITTINGS  
ACCESSORIES

# FIELD ATTACHABLE COUPLINGS

## V000 SERIES FIELD ATTACHABLE COUPLINGS

V000 FERRULE	6240 INSERT	V240 COUPLING	JSEAL™ / JIC
--------------	-------------	---------------	--------------

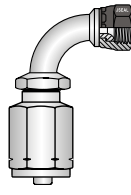
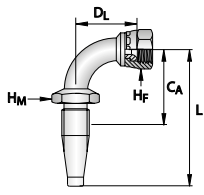
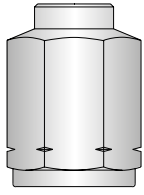

CONVEX SEAT

		JSEAL™ / JIC FEMALE 90° TUBE BEND						HOSE SIZE ACTUAL ID		THRD SIZE	DASH SIZE	BACK UP AF	FEMALE HEX			
PART NO	PART NO	CA		L		DL		PART NO	DN	inch	inch		AF-SPANNER		HF-SPANNER	
		inch	mm	inch	mm	inch	mm						inch	mm	inch	mm
V000-04	6240-0307	1.30	33	2.09	53	1.26	32	V240-0307	5	3/16	7/16" -20	-0307	5/8	16	9/16	
V000-05	6240-0407	1.50	38	2.56	65	1.06	27	V240-0407	6	1/4	7/16" -20	-0407	5/8	16	9/16	
V000-05	6240-0408	1.54	39	2.60	66	1.14	29	V240-0408	6	1/4	1/2" -20	-0408	5/8	16	5/8	16
V000-05	6240-0409	1.42	36	2.48	63	1.14	29	V240-0409	6	1/4	9/16" -18	-0409	5/8	16	11/16	
V000-06	6240-0509	1.77	45	2.83	72	1.18	30	V240-0509	8	5/16	9/16" -18	-0509	5/8	16	11/16	
V000-08	6240-0609	1.73	44	3.03	77	0.98	25	V240-0609	10	3/8	9/16" -18	-0609	11/16		11/16	
V000-08	6240-0612	1.73	44	3.03	77	1.18	30	V240-0612	10	3/8	3/4" -16	-0612	11/16		7/8	22
V000-10	6240-0812	2.13	54	3.43	87	1.50	38	V240-0812	12	1/2	3/4" -16	-0812	13/16		7/8	22
V000-10	6240-0814	2.13	54	3.43	87	1.85	47	V240-0814	12	1/2	7/8" -14	-0814	13/16		1	
V000-12	6240-1014	2.36	60	3.78	96	1.89	48	V240-1014	16	5/8	7/8" -14	-1014	1		1	
V000-12	6240-1017	2.44	62	3.86	98	1.93	49	V240-1017	16	5/8	1.1/16" -12	-1017	1		1.1/4	32
	6240-1217	2.52	64	3.98	101	2.24	57	V240-1217	19	3/4	1.1/16" -12	-1217	1.1/16	27	1.1/4	32
	6240-1221	2.76	70	4.21	107	2.80	71	V240-1221	19	3/4	1.5/16" -12	-1221	1.1/4	32	1.1/2	38
	6240-1421	3.03	77	4.09	104	2.83	72	V240-1421	22	7/8	1.5/16" -12	-1421	1.3/8	35	1.1/2	38
	6240-1617	3.03	77	4.57	116	2.28	58	V240-1617	25	1	1.1/16" -12	-1617	1.3/8	35	1.1/4	32
	6240-1621	3.31	84	4.84	123	2.83	72	V240-1621	25	1	1.5/16" -12	-1621	1.3/8	35	1.1/2	38
	6240-1826	4.06	103	5.31	135	3.19	81	V240-1826	28	1.1/8	1.5/8" -12	-1826	1.3/4		2	50
V000-22	6240-2026	4.21	107	6.34	161	3.23	82	V240-2026	31	1.1/4	1.5/8" -12	-2026	1.3/4		2	50
V000-24	6240-2230	4.45	113	5.75	146	4.09	104	V240-2230	35	1.3/8	1.7/8" -12	-2230	2	50	2.1/4	57

## V000 SERIES FIELD ATTACHABLE COUPLINGS

<b>V000 FERRULE</b>	<b>6280 INSERT</b>	<b>V280 COUPLING</b>	<b>JSEAL™ / JIC</b>
---------------------	--------------------	----------------------	---------------------

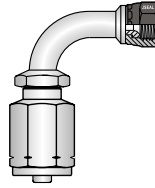
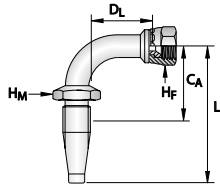
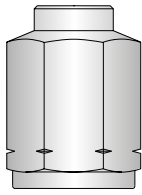

CONVEX SEAT

		JSEAL™ / JIC FEMALE 90° LONG TUBE BEND						HOSE SIZE ACTUAL ID		THRDS SIZE	DASH SIZE	BACK UP AF	FEMALE HEX			
PART NO	PART NO	CA		L		DL		PART NO	DN	inch	inch		AF-SPANNER		HF-SPANNER	
		inch	mm	inch	mm	inch	mm						inch	mm	inch	mm
V000-05	6280-0407	1.69	43	2.76	70	1.85	47	V280-0407	6	1/4	7/16" -20	-0407	5/8	16	9/16	
V000-05	6280-0408	1.54	39	2.60	66	1.85	47	V280-0408	6	1/4	1/2" - 20	-0408	5/8	16	5/8	16
V000-05	6280-0409	1.54	39	2.60	66	2.13	54	V280-0409	6	1/4	9/16" -18	-0409	5/8	16	11/16	
V000-06	6280-0509	1.89	48	2.95	75	2.17	55	V280-0509	8	5/16	9/16" -18	-0509	5/8	16	11/16	
V000-08	6280-0609	1.61	41	2.91	74	2.17	55	V280-0609	10	3/8	9/16" -18	-0609	11/16		11/16	
V000-08	6280-0612	1.73	44	3.03	77	2.52	64	V280-0612	10	3/8	3/4" -16	-0612	11/16		7/8	22
V000-10	6280-0812	2.09	53	3.39	86	2.36	60	V280-0812	12	1/2	3/4" -16	-0812	13/16		7/8	22
V000-10	6280-0814	2.09	53	3.39	86	2.76	70	V280-0814	12	1/2	7/8" -14	-0814	13/16		1	
V000-12	6280-1014	2.44	62	3.86	98	2.76	70	V280-1014	16	5/8	7/8" -14	-1014	1		1	
V000-12	6280-1017	2.44	62	3.86	98	3.78	96	V280-1017	16	5/8	1.1/16" -12	-1017	1		1.1/4	32
	6280-1217	2.68	68	4.13	105	3.78	96	V280-1217	19	3/4	1.1/16" -12	-1217	1.1/16	27	1.1/4	32
	6280-1621	3.58	91	5.12	130	4.49	114	V280-1621	25	1	1.5/16" -12	-1621	1.3/8	35	1.1/2	38
	6280-2026	4.13	105	6.26	159	5.08	129	V280-2026	31	1.1/4	1.5/8" -12	-2026	1.3/4		2	50
	6280-2430	4.76	121	7.24	184	5.55	141	V280-2430	38	1.1/2	1.7/8" -12	-2430	2.1/4	57	2.1/4	57

INTRODUCTION

INDEXES

ONE-PIECE COUPLINGS

PUSH-ON SUCTION & RETURN COUPLINGS

FIELD ATTACHABLE COUPLINGS

HYDRAULIC FITTINGS ACCESSORIES

**NOTE:** Hose Compatibility for the V000 series can be found on page 238.

# FIELD ATTACHABLE COUPLINGS

## V000 SERIES FIELD ATTACHABLE COUPLINGS

V000 FERRULE	6800 INSERT	V800 COUPLING	ORFS
--------------	-------------	---------------	------

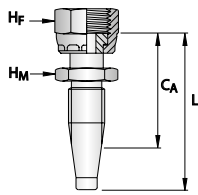
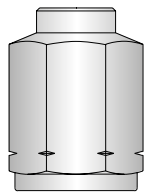

O RING FACE SEAL

PART NO	ORFS FEMALE					PART NO	HOSE SIZE		THRD SIZE	DASH SIZE	BACK UP Af	FEMALE HEX		
	CA	L		DN	inch		inch	Af-SPANNER				Hf-SPANNER		
	inch	mm	inch	mm							inch	mm	inch	mm
V000-04	6800-0309	1.26	32	2.09	53	V800-0309	5	3/16	9/16" - 18	-0309	5/8	16	11/16	
V000-05	6800-0409	1.50	38	2.52	64	V800-0409	6	1/4	9/16" - 18	-0409	5/8	16	11/16	
V000-05	6800-0411	1.57	40	2.60	66	V800-0411	6	1/4	11/16" -16	-0411	11/16		13/16	
V000-06	6800-0511	1.46	37	2.56	65	V800-0511	8	5/16	11/16" -16	-0511	5/8	16	13/16	
V000-08	6800-0611	1.42	36	2.76	70	V800-0611	10	3/8	11/16" -16	-0611	11/16		13/16	
V000-08	6800-0613	1.54	39	2.87	73	V800-0613	10	3/8	13/16" - 16	-0613	13/16		15/16	24
V000-10	6800-0813	1.61	41	2.91	74	V800-0813	12	1/2	13/16" - 16	-0813	13/16		15/16	24
V000-10	6800-0816	1.85	47	3.11	79	V800-0816	12	1/2	1" - 14	-0816	15/16	24	1.1/8	
V000-12	6800-1016	1.93	49	3.35	85	V800-1016	16	5/8	1" - 14	-1016	1.1/8		1.1/8	
V000-12	6800-1019	2.05	52	3.46	88	V800-1019	16	5/8	1.3/16" - 12	-1019	1.1/8		1.3/8	35
	6800-1219	1.97	50	3.46	88	V800-1219	19	3/4	1.3/16" - 12	-1219	1.1/8		1.3/8	35
	6800-1223	2.40	61	3.86	98	V800-1223	19	3/4	1.7/16" - 12	-1223	1.3/8	35	1.5/8	41
	6800-1423	2.32	59	3.39	86	V800-1423	22	7/8	1.7/16" - 12	-1423	1.3/8	35	1.5/8	41
	6800-1623	2.56	65	4.09	104	V800-1623	25	1	1.7/16" - 12	-1623	1.3/8	35	1.5/8	41
	6800-2027	2.83	72	4.96	126	V800-2027	31	1.1/4	1.11/16" - 12	-2027	1.43/50		1.7/8	

**NOTE:** Hose Compatibility for the V000 series can be found on page 238.

## V000 SERIES FIELD ATTACHABLE COUPLINGS

V000 FERRULE	6810 INSERT	V810 COUPLING	ORFS
--------------	-------------	---------------	------

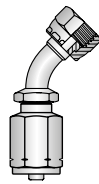
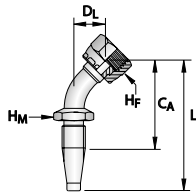
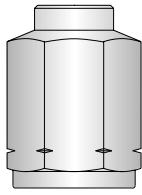

O RING FACE SEAL

		ORFS FEMALE 45° TUBE BEND				HOSE SIZE ACTUAL ID		THRD SIZE	DASH SIZE	BACK UP Af	FEMALE HEX			
PART NO	PART NO	CA		L		PART NO	DN	inch	inch		AF-SPANNER		HF-SPANNER	
		inch	mm	inch	mm						inch	mm	inch	mm
V000-04	6810-0309	1.81	46	2.60	66	V810-0309	5	3/16	9/16" - 18	-0309	5/8	16	11/16	
V000-05	6810-0409	2.01	51	3.07	78	V810-0409	6	1/4	9/16" - 18	-0409	5/8	16	11/16	
V000-05	6810-0411	2.01	51	3.07	78	V810-0411	6	1/4	11/16" - 16	-0411	5/8	16	7/8	22
V000-06	6810-0511	2.13	54	3.23	82	V810-0511	8	5/16	11/16" - 16	-0511	5/8	16	7/8	22
V000-08	6810-0611	2.09	53	3.43	87	V810-0611	10	3/8	11/16" - 16	-0611	11/16		7/8	22
V000-08	6810-0613	1.93	49	3.23	82	V810-0613	10	3/8	13/16" - 16	-0613	3/4	19	15/16	24
V000-10	6810-0813	2.36	60	3.66	93	V810-0813	12	1/2	13/16" - 16	-0813	13/16		15/16	24
V000-10	6810-0816	2.48	63	3.78	96	V810-0816	12	1/2	1" - 14	-0816	15/16	24	1.1/8	
V000-12	6810-1016	2.87	73	4.29	109	V810-1016	16	5/8	1" - 14	-1016	1		1.1/8	
V000-12	6810-1019	2.99	76	4.41	112	V810-1019	16	5/8	1.3/16" - 12	-1019	1.1/8		1.3/8	
	6810-1219	2.99	76	4.49	114	V810-1219	19	3/4	1.3/16" - 12	-1219	1.1/8		1.3/8	
	6810-1223	3.03	77	4.53	115	V810-1223	19	3/4	1.7/16" - 12	-1223	1.3/8	35	1.5/8	41
	6810-1423	3.74	95	4.80	122	V810-1423	22	7/8	1.7/16" - 12	-1423	1.3/8	35	1.5/8	41
	6810-1623	3.98	101	5.51	140	V810-1623	25	1	1.7/16" - 12	-1623	1.3/8	35	1.5/8	41

V000 FERRULE	6820 INSERT	V820 COUPLING	ORFS
--------------	-------------	---------------	------

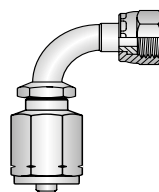
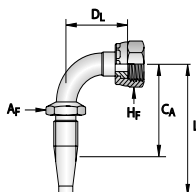
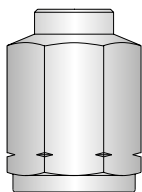

O RING FACE SEAL

		ORFS FEMALE 90° TUBE BEND				HOSE SIZE ACTUAL ID		THRD SIZE	DASH SIZE	BACK UP Af	FEMALE HEX			
PART NO	PART NO	CA		L		PART NO	DN	inch	inch		AF-SPANNER		HF-SPANNER	
		inch	mm	inch	mm						inch	mm	inch	mm
V000-04	6820-0309	1.38	35	2.17	55	V820-0309	5	3/16	9/16" - 18	-0309	5/8	16	11/16	
V000-05	6820-0409	1.57	40	2.64	67	V820-0409	6	1/4	9/16" - 18	-0409	5/8	16	11/16	
V000-05	6820-0411	1.57	40	2.64	67	V820-0411	6	1/4	11/16" - 16	-0411	5/8	16	13/16	
V000-06	6820-0511	1.73	44	2.80	71	V820-0511	8	5/16	11/16" - 16	-0511	5/8	16	13/16	
V000-08	6820-0611	1.69	43	2.99	76	V820-0611	10	3/8	11/16" - 16	-0611	11/16		13/16	
V000-08	6820-0613	1.69	43	2.99	76	V820-0613	10	3/8	13/16" - 16	-0613	3/4	19	15/16	24
V000-10	6820-0813	2.05	52	3.35	85	V820-0813	12	1/2	13/16" - 16	-0813	13/16		15/16	24
V000-10	6820-0816	2.17	55	3.46	88	V820-0816	12	1/2	1" - 14	-0816	15/16	24	1.1/8	
V000-12	6820-1016	2.40	61	3.82	97	V820-1016	16	5/8	1" - 14	-1016	1		1.1/8	
V000-12	6820-1019	2.52	64	3.94	100	V820-1019	16	5/8	1.3/16" - 12	-1019	1.1/8		1.3/8	35
	6820-1219	2.60	66	4.06	103	V820-1219	19	3/4	1.3/16" - 12	-1219	1.1/8		1.3/8	35
	6820-1223	2.80	71	4.25	108	V820-1223	19	3/4	1.7/16" - 12	-1223	1.3/8	35	1.5/8	41
	6820-1423	3.11	79	4.17	106	V820-1423	22	7/8	1.7/16" - 12	-1423	1.3/8	35	1.5/8	41
	6820-1623	3.35	85	4.88	124	V820-1623	25	1	1.7/16" - 12	-1623	1.3/8	35	1.5/8	41
	6820-2027	4.17	106	6.30	160		31	1.1/4	1.11/16" - 12	-2027	1.3/4		1.7/8	

# FIELD ATTACHABLE COUPLINGS

## V000 SERIES FIELD ATTACHABLE COUPLINGS

V000 FERRULE	6830 INSERT	V830 COUPLING	ORFS
--------------	-------------	---------------	------

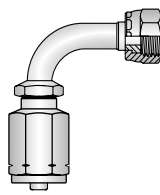
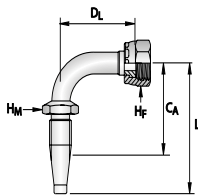
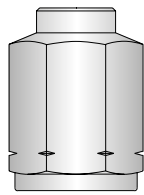

O RING FACE SEAL

PART NO	ORFS FEMALE 90° LONG TUBE BEND					PART NO	HOSE SIZE ACTUAL ID		THRD SIZE	DASH SIZE	BACK UP Af	FEMALE HEX		
	CA	L		DN	inch		inch	Af-SPANNER				Hf-SPANNER		
	inch	mm	inch	mm							inch	mm	inch	mm
V000-04	6830-0309	1.38	35	2.20	56	V830-0309	5	3/16	9/16" - 18	-0309	5/8	16	11/16	
V000-05	6830-0409	1.61	41	2.64	67	V830-0409	6	1/4	9/16" - 18	-0409	5/8	16	11/16	
V000-05	6830-0411	1.57	40	2.64	67	V830-0411	6	1/4	11/16" - 16	-0411	5/8	16	13/16	
V000-06	6830-0511	1.61	41	2.72	69	V830-0511	8	5/16	11/16" - 16	-0511	5/8	16	13/16	
V000-08	6830-0611	1.61	41	2.91	74	V830-0611	10	3/8	11/16" - 16	-0611	11/16		13/16	
V000-08	6830-0613	1.61	41	2.91	74	V830-0613	10	3/8	13/16" - 16	-0613	3/4	19	15/16	24
V000-10	6830-0813	2.09	53	3.39	86	V830-0813	12	1/2	13/16" - 16	-0813	13/16		15/16	24
V000-10	6830-0816	2.28	58	3.58	91	V830-0816	12	1/2	1" - 14	-0816	15/16	24	1.1/8	
V000-12	6830-1016	2.56	65	3.98	101	V830-1016	16	5/8	1" - 14	-1016	1		1.1/8	
V000-12	6830-1019	2.48	63	3.90	99	V830-1019	16	5/8	1.3/16" - 12	-1019	1.1/8		1.3/8	35
	6830-1219	2.80	71	4.25	108	V830-1219	19	3/4	1.3/16" - 12	-1219	1.1/8		1.3/8	35
	6830-1223	2.76	70	4.21	107	V830-1223	19	3/4	1.7/16" - 12	-1223	1.3/8	35	1.5/8	41
	6830-1423	3.43	87	4.49	114	V830-1423	22	7/8	1.7/16" - 12	-1423	1.3/8	35	1.5/8	41
	6830-1623	3.66	93	5.20	132	V830-1623	25	1	1.7/16" - 12	-1623	1.3/8	35	1.5/8	41
	6830-2027	4.17	106	6.30	160	V830-2027	31	1.1/4	1.11/16" - 12	-2027	1.3/4		1.7/8	

## V000 SERIES FIELD ATTACHABLE COUPLINGS

<b>V000 FERRULE</b>	<b>6530 INSERT</b>	<b>V530 COUPLING</b>	<b>SAE</b>
---------------------	--------------------	----------------------	------------

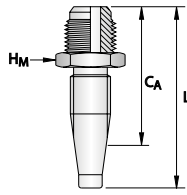
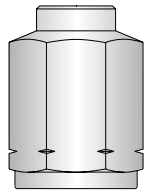

45° FLARE

		SAE MALE				HOSE SIZE ACTUAL ID		THRD SIZE	DASH SIZE	BACK UP Af	FEMALE HEX			
PART NO	PART NO	CA		L		PART NO	DN	inch	inch		Af-SPANNER		Hf-SPANNER	
		inch	mm	inch	mm						inch	mm	inch	mm
V000-05	6530-0410	1.46	37	2.48	63	V530-0410	6	1/4	5/8" -18	-0410	11/16		0	0
V000-06	6530-0510	1.34	34	2.40	61	V530-0510	8	5/16	5/8" -18	-0510	5/8	16	0	0
V000-08	6530-0608	1.26	32	2.56	65	V530-0608	10	3/8	1/2" -20	-0608	5/8	16	0	0
V000-08	6530-0610	1.30	33	2.60	66	V530-0610	10	3/8	5/8" -18	-0610	3/4	19	0	0

<b>V000 FERRULE</b>	<b>6540 INSERT</b>	<b>V540 COUPLING</b>	<b>SAE</b>
---------------------	--------------------	----------------------	------------

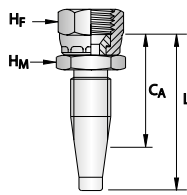
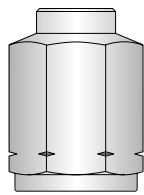

45° FLARE

		SAE FEMALE				HOSE SIZE ACTUAL ID		THRD SIZE	DASH SIZE	BACK UP Af	FEMALE HEX			
PART NO	PART NO	CA		L		PART NO	DN	inch	inch		Af-SPANNER		Hf-SPANNER	
		inch	mm	inch	mm						inch	mm	inch	mm
V000-04	6540-0307	0.91	23	1.73	44	V540-0307	5	3/16	7/16" - 20	-0307	5/8	16	9/16	
V000-05	6540-0407	1.14	29	2.17	55	V540-0407	6	1/4	7/16" - 20	-0407	11/16		9/16	
V000-05	6540-0408	1.14	29	2.17	55	V540-0408	6	1/4	1/2" -20	-0408	11/16		5/8	16
V000-05	6540-0410	1.14	29	2.20	56	V540-0410	6	1/4	5/8" -18	-0410	11/16		3/4	19
V000-06	6540-0510	1.06	27	2.13	54	V540-0510	8	5/16	5/8" -18	-0510	11/16		3/4	19
V000-08	6540-0608	1.02	26	2.32	59	V540-0608	10	3/8	1/2" -20	-0608	11/16		5/8	16
V000-08	6540-0610	1.02	26	2.36	60	V540-0610	10	3/8	5/8" -18	-0610	3/4	19	3/4	19
V000-08	6540-0612	1.14	29	2.44	62	V540-0612	10	3/8	3/4" -16	-0612	7/8	22	7/8	22
V000-10	6540-0812	1.26	32	2.56	65	V540-0812	12	1/2	3/4" -16	-0812	7/8	22	7/8	22
V000-10	6540-0814	1.30	33	2.60	66	V540-0814	12	1/2	7/8" -14	-0814	1		1.1/16	27
	6540-1017	1.50	38	2.91	74	V540-1017	16	5/8	1.1/16" -12	-1017	1.1/8		1.1/4	32
	6540-1217	1.42	36	2.91	74	V540-1217	19	3/4	1.1/16" -12	-1217	1.1/8		1.1/4	32

**NOTE:** Hose Compatibility for the V000 series can be found on page 238.

# FIELD ATTACHABLE COUPLINGS

## V000 SERIES FIELD ATTACHABLE COUPLINGS

<b>V000 FERRULE</b>	<b>6550 INSERT</b>	<b>V550 COUPLING</b>	<b>SAE</b>
---------------------	--------------------	----------------------	------------

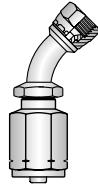
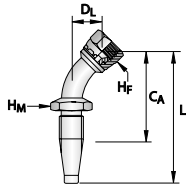
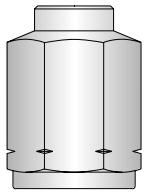

45° FLARE

		SAE FEMALE 45° TUBE BEND				HOSE SIZE ACTUAL ID		THRD SIZE	DASH SIZE	BACK UP Af	FEMALE HEX			
PART NO	PART NO	Ca		L		PART NO	DN	inch	inch		Af-SPANNER		Hf-SPANNER	
		inch	mm	inch	mm						inch	mm	inch	mm
V000-04	6550-0307	1.57	40	2.36	60	V550-0307	5	3/16	7/16" - 20	-0307	5/8	16	9/16	
V000-06	6550-0510	2.01	51	3.07	78	V550-0510	8	5/16	5/8" - 18	-0510	5/8	16	3/4	19
V000-08	6550-0608	1.89	48	3.23	82	V550-0608	10	3/8	1/2" - 20	-0608	11/16		5/8	16
V000-08	6550-0610	1.97	50	3.27	83	V550-0610	10	3/8	5/8" - 18	-0610	11/16		3/4	19

<b>V000 FERRULE</b>	<b>6560 INSERT</b>	<b>V560 COUPLING</b>	<b>SAE</b>
---------------------	--------------------	----------------------	------------

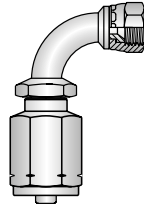
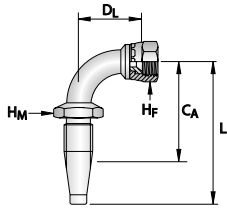
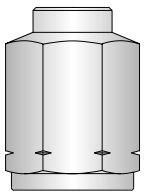

45° FLARE

		SAE FEMALE 90° TUBE BEND				HOSE SIZE ACTUAL ID		THRD SIZE	DASH SIZE	BACK UP Af	FEMALE HEX			
PART NO	PART NO	Ca		L		PART NO	DN	inch	inch		Af-SPANNER		Hf-SPANNER	
		inch	mm	inch	mm						inch	mm	inch	mm
V000-04	6560-0307	1.30	33	2.13	54	V560-0307	5	3/16	7/16" - 20	-0307	5/8	16	9/16	
V000-06	6560-0510	1.73	44	2.80	71	V560-0510	8	5/16	5/8" - 18	-0510	5/8	16	3/4	19
V000-08	6560-0610	1.69	43	2.99	76	V560-0610	10	3/8	5/8" - 18	-0610	11/16		3/4	19

<b>V000 FERRULE</b>	<b>6740 INSERT</b>	<b>V740 COUPLING</b>	<b>SAE</b>
---------------------	--------------------	----------------------	------------

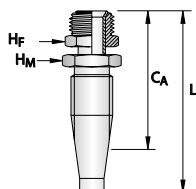
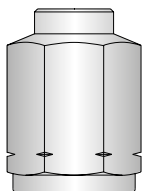

INVERTED MALE FLARE

		SAE INVERTED MALE FLARE				HOSE SIZE ACTUAL ID		THRD SIZE	DASH SIZE	BACK UP Af	FEMALE HEX			
PART NO	PART NO	Ca		L		PART NO	DN	inch	inch		Af-SPANNER		Hf-SPANNER	
		inch	mm	inch	mm						inch	mm	inch	mm
V000-05	6740-0407	1.97	50	3.03	77	V740-0407	6	1/4	7/16" - 20	-0407	5/8	16	7/16	11
V000-06	6740-0510	1.89	48	2.95	75	V740-0510	8	5/16	5/8" - 18	-0510	5/8	16	5/8	16
V000-08	6740-0610	1.85	47	3.15	80	V740-0610	10	3/8	5/8" - 18	-0610	11/16		5/8	16
V000-08	6740-0611	1.97	50	3.31	84	V740-0611	10	3/8	11/16" - 16	-0611	11/16		11/16	

**NOTE:** Hose Compatibility for the V000 series can be found on page 238.

## V000 SERIES FIELD ATTACHABLE COUPLINGS

<b>V000 FERRULE</b>	<b>6750 INSERT</b>	<b>V750 COUPLING</b>	<b>SAE</b>
---------------------	--------------------	----------------------	------------

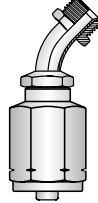
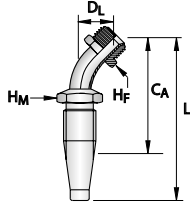
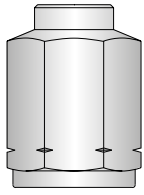

**INVERTED MALE FLARE**

	<b>SAE INVERTED MALE FLARE 45° TUBE BEND</b>					<b>HOSE SIZE ACTUAL ID</b>	<b>THRD SIZE</b>	<b>DASH SIZE</b>	<b>BACK UP AF</b>	<b>FEMALE HEX</b>
--	--	--	--	--	--	----------------------------	------------------	------------------	-------------------	-------------------

PART NO	PART NO	C <sub>A</sub>		L		PART NO	DN	inch	inch		A <sub>F</sub> -SPANNER		H <sub>F</sub> -SPANNER	
		inch	mm	inch	mm						inch	mm	inch	mm
<b>V000-06</b>	<b>6750-0510</b>	3.15	80	4.21	107	<b>V750-0510</b>	8	5/16	5/8" -18	-0510	5/8	16	5/8	16
<b>V000-08</b>	<b>6750-0610</b>	3.11	79	4.45	113	<b>V750-0610</b>	10	3/8	5/8" -18	-0610	11/16		5/8	16

<b>V000 FERRULE</b>	<b>6770 INSERT</b>	<b>V770 COUPLING</b>	<b>SAE</b>
---------------------	--------------------	----------------------	------------

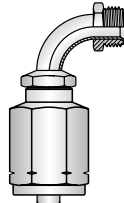
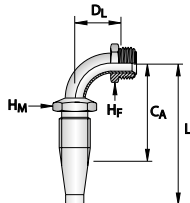
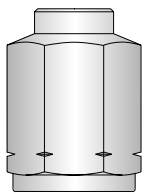

**INVERTED MALE FLARE**

	<b>SAE INVERTED MALE FLARE 90° TUBE BEND</b>					<b>HOSE SIZE ACTUAL ID</b>	<b>THRD SIZE</b>	<b>DASH SIZE</b>	<b>BACK UP AF</b>	<b>FEMALE HEX</b>
--	--	--	--	--	--	----------------------------	------------------	------------------	-------------------	-------------------

PART NO	PART NO	C <sub>A</sub>		L		PART NO	DN	inch	inch		A <sub>F</sub> -SPANNER		H <sub>F</sub> -SPANNER	
		inch	mm	inch	mm						inch	mm	inch	mm
<b>V000-05</b>	<b>6770-0407</b>	2.05	52	3.07	78	<b>V770-0407</b>	6	1/4	7/16" - 20	-0407	5/8	16	7/16	11
<b>V000-06</b>	<b>6770-0510</b>	2.44	62	3.50	89	<b>V770-0510</b>	8	5/16	5/8" -18	-0510	5/8	16	5/8	16
<b>V000-08</b>	<b>6770-0610</b>	2.40	61	3.70	94	<b>V770-0610</b>	10	3/8	5/8" -18	-0610	11/16		5/8	16

**NOTE:** Hose Compatibility for the **V000** series can be found on page 238.

# FIELD ATTACHABLE COUPLINGS

## V000 SERIES FIELD ATTACHABLE COUPLINGS

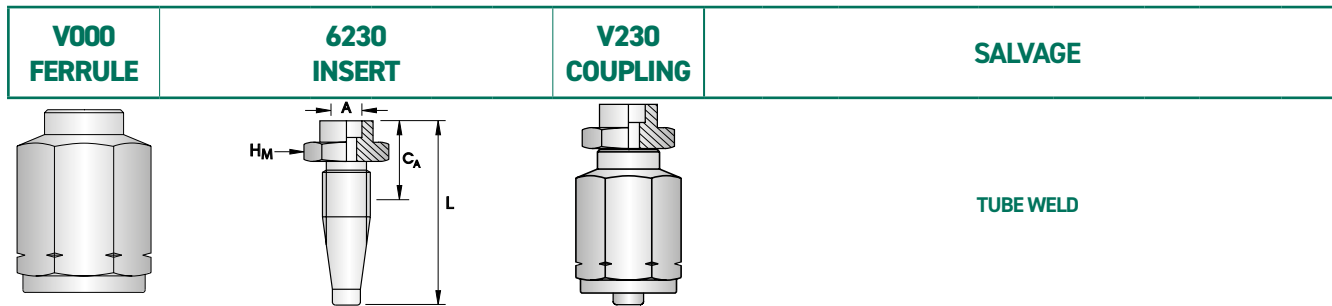

		SALVAGE (LIFESAVER)				HOSE SIZE ACTUAL ID		TUBE SIZE	DASH SIZE	BACK UP Af	FEMALE HEX			
PART NO	PART NO	CA		L		PART NO	DN	inch	inch		Af-SPANNER		Hf-SPANNER	
		inch	mm	inch	mm						inch	mm	inch	mm
V000-04	6230-0304	0.87	22	1.69	43	V230-0304	5	3/16	1/4	-0304	5/8	16		
V000-05	6230-0404	1.10	28	2.13	54	V230-0404	6	1/4	1/4	-0404	5/8	16		
V000-05	6230-0406	1.10	28	2.13	54	V230-0406	6	1/4	3/8	-0406	5/8	16		
V000-06	6230-0506	0.98	25	2.09	53	V230-0506	8	5/16	3/8	-0506	5/8	16		
V000-08	6230-0606	0.94	24	2.28	58	V230-0606	10	3/8	3/8	-0606	11/16			
V000-08	6230-0608	0.94	24	2.28	58	V230-0608	10	3/8	1/2	-0608	11/16			
V000-10	6230-0808	1.14	29	2.44	62	V230-0808	12	1/2	1/2	-0808	13/16			
V000-10	6230-0810	1.14	29	2.44	62	V230-0810	12	1/2	5/8	-0810	7/8	22		
V000-10	6230-0812	1.14	29	2.44	62	V230-0812	12	1/2	3/4	-0812	1.1/16	27		
V000-12	6230-1010	1.22	31	2.64	67	V230-1010	16	5/8	5/8	-1010	1			
V000-12	6230-1012	1.22	31	2.64	67	V230-1012	16	5/8	3/4	-1012	1			
	6230-1212	1.18	30	2.64	67	V230-1212	19	3/4	3/4	-1212	1.1/16	27		
	6230-1216	1.34	34	2.83	72	V230-1216	19	3/4	1	-1216	1.3/8	35		
V000-16	6230-1416	1.26	32	2.36	60	V230-1416	22	7/8	1	-1416	1.3/8	35		
	6230-1612	1.46	37	2.99	76	V230-1612	25	1	3/4	-1612	1.3/8	35		
	6230-1616	1.54	39	3.07	78	V230-1616	25	1	1	-1616	1.3/8	35		
	6230-1620	1.57	40	3.11	79	V230-1620	25	1	1.1/4	-1620	1.3/4			
V000-20	6230-1820	1.61	41	2.91	74	V230-1820	28	1.1/8	1.1/4	-1820	1.43/50			
	6230-2020	1.73	44	3.86	98	V230-2020	31	1.1/4	1.1/4	-2020	1.3/4			
V000-24	6230-2224	1.34	34	2.64	67	V230-2224	35	1.3/8	1.1/2	-2224	2	50		
	6230-2424	1.57	40	4.06	103	V230-2424	38	1.1/2	1.1/2	-2424	2.1/4	57		
	6230-3232	1.97	50	4.76	121	V230-3232	51	2	2	-3232	2.1/2			

**NOTE:** Hose Compatibility for the V000 series can be found on page 238.

## V000 SERIES FIELD ATTACHABLE COUPLINGS

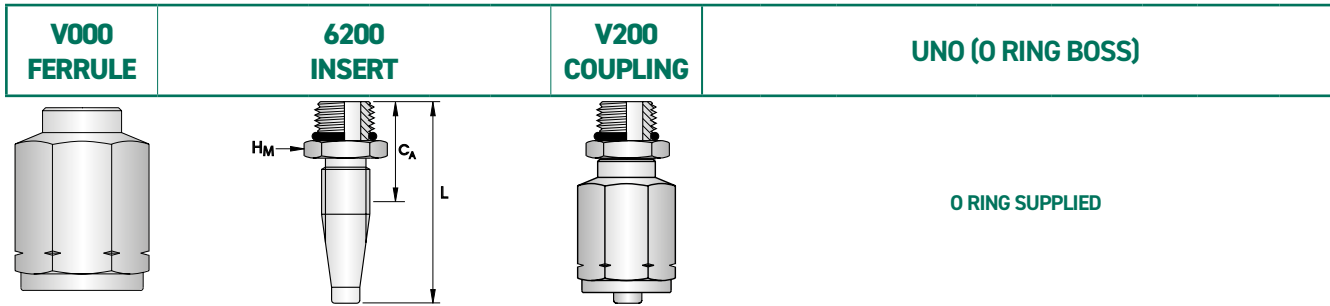

		UN O RING MALE (O RING BOSS)				HOSE SIZE ACTUAL ID		THRD SIZE	DASH SIZE	BACK UP AF	FEMALE HEX			
PART NO	PART NO	CA		L		PART NO	DN	inch	inch		AF-SPANNER		HF-SPANNER	
		inch	mm	inch	mm						inch	mm	inch	mm
V000-05	6200-0409	1.22	31	2.24	57	V200-0409	6	1/4	9/16" -18	-0409	11/16			
V000-08	6200-0609	1.06	27	2.40	61	V200-0609	10	3/8	9/16" -18	-0609	3/4	19		
V000-08	6200-0612	1.18	30	2.52	64	V200-0612	10	3/8	3/4" -14	-0612	7/8	22		
V000-08	6200-0614	1.26	32	2.56	65	V200-0614	10	3/8	7/8" -14	-0614	1			
V000-10	6200-0812	1.30	33	2.60	66	V200-0812	12	1/2	3/4" -14	-0812	7/8	22		
V000-10	6200-0814	1.38	35	2.68	68	V200-0814	12	1/2	7/8" -14	-0814	1			
V000-10	6200-0817	1.54	39	2.83	72	V200-0817	12	1/2	1.1/16" -12	-0817	1.1/4	32		
V000-12	6200-1014	1.69	43	3.11	79	V200-1014	16	5/8	7/8" -14	-1014	1.1/8			
V000-12	6200-1017	1.61	41	3.03	77	V200-1017	16	5/8	1.1/16" -12	-1017	1.1/4	32		
V000-12	6200-1021	1.69	43	3.11	79	V200-1021	16	5/8	1.5/16" -12	-1021	1.1/2	38		
	6200-1217	1.54	39	3.03	77	V200-1217	19	3/4	1.1/16" -12	-1217	1.1/4	32		
	6200-1221	1.61	41	3.11	79	V200-1221	19	3/4	1.5/16" -12	-1221	1.1/2	38		
	6200-1617	1.97	50	3.50	89		25	1	1.1/16" -12	-1617	1.1/4	32		
	6200-1619	1.77	45	3.31	84		25	1	1.3/16" -12	-1619	1.3/8	35		
	6200-1621	1.77	45	3.31	84		25	1	1.5/16" -12	-1621	1.1/2	38		

**NOTE:** Hose Compatibility for the **V000** series can be found on page 238.

# FIELD ATTACHABLE COUPLINGS

## 6000 SERIES FIELD ATTACHABLE INSERTS

### HOSE COMPATIBILITY FOR 6000 SERIES

#### FIELD ATTACHABLE FERRULES FOR 6000 SERIES INSERTS

The Ryco Field Attachable system consists of five ferrule styles, each specific to a hose type, and one common insert.

Field attachable inserts and ferrules can be ordered individually, or as a complete coupling for specific hose types.

Field Attachable Inserts for Ryco Hose Series T1D, T2D, TXA2D, SURVIVOR/1, SURVIVOR/2, SURVIVOR/R5, T1F, M2, M2G, BT1, E1, E2, T5.

For **V000** Series for SURVIVOR/R5 and T5 Hose Series, see pages 343 to 354.

**6000** Series Inserts are used with NON-SKIVE Ferrules **K000**, **L000**, **M000**, **P000** and **V000** Series.

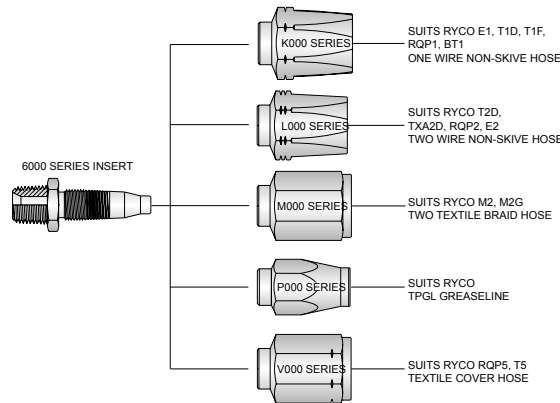

V000 Series Couplings for T5 Hose Series are shown on pages 343 to 354.

6000 Series Inserts, for use with **K000**, **L000**, **M000** and **P000** Series Ferrules, are shown on pages 357 to 387

FERRULES			K000	L000	M000	P000					
SUITS RYCO HOSE TYPE			ONE WIRE BRAID NON-SKIVE	TWO WIRE BRAID NON-SKIVE	TWO TEXTILE BRAID	GREASILINE					
SUITS RYCO HOSE SERIES			RYCO T1D, T1F, SURVIVOR/1, BT1	RYCO T2D, TXA2D, SURVIVOR/2, E2	RYCO M2, M2G	RYCO TPGL					
HOSE SIZE	USE INSERT		CA ADJ	CA ADJ	CA ADJ	CA ADJ					
DN	inch	Dash	Series	Part No	mm	Part No	mm	Part No	mm	Part No	mm
	1/8	-02	<b>6000-02</b>							<b>P000-02</b>	0
5	3/16	-03	<b>6000-03</b>								
6	1/4	-04	<b>6000-04</b>	<b>K000-04</b>	0	<b>L000-04</b>	0	<b>M000-04</b>	0		
10	3/8	-06	<b>6000-06</b>	<b>K000-06</b>	0	<b>L000-06</b>	0	<b>M000-06</b>	0		
12	1/2	-08	<b>6000-08</b>	<b>K000-08</b>	+3	<b>L000-08</b>	0	<b>M000-08</b>	0		
16	5/8	-10	<b>6000-10</b>	<b>K000-10</b>	+1	<b>L000-10</b>	0				
19	3/4	-12	<b>6000-12</b>	<b>K000-12</b>	+2	<b>L000-12</b>	0	<b>M000-12</b>	0		
25	1	-16	<b>6000-16</b>	<b>K000-16</b>	0	<b>L000-16</b>	0	<b>M000-16</b>	-2		
31	1.1/4	-20	<b>6000-20</b>			<b>L000-20</b>	0				
38	1.1/2	-24	<b>6000-24</b>								
51	2	-32	<b>6000-32</b>								

**NOTE:** For previous Part Number series, remove a zero from the end of the new series Part Number. Eg, **K000** series was previously **K00** series. Part Number **L000-04** was previously **L00-04**. The exception is **M000**, which was previously the **400** series.

## 6000 SERIES FIELD ATTACHABLE INSERTS

### ALL SERIES (EXCEPT V SERIES)

Field Attachable Inserts and Ferrules can be ordered individually, or as complete Couplings. Each Ferrule Series is specific to a hose type as detailed on the previous page. For all Series, except V Series\*, the following method is used:

- EXAMPLE 1** To order 1/2" NPT male Insert and Ferrule for 1/2" two wire non-skive hose (T2D).
- (a) Individually Order Insert **6090-0808** (6000 Series). See NPT 6000 Series Inserts on page 248.  
Order Ferrule **L000-08**.  
L000 Series Ferrules are used on T2D hose; see table on the previous page.  
Dash Size -08 part of **L000-08** comes from 1/2" hose =  $8/16" = -08$ ; or from the tables.
- (b) Complete Coupling Order **L090-0808**.  
Simply replace the first character of the Insert part number with the first character of the Ferrule part number.  
(replace 6 with L) = **6090-0808 »» L090-0808**

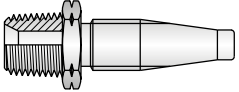
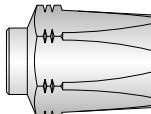
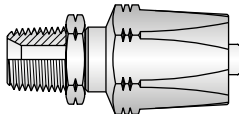
6090-0808 Insert	plus L000-08 Ferrule equals	L090-0808 complete Coupling
		

- EXAMPLE 2** To order 3/4"-16 JIC female Insert and Ferrule for 3/8" SURVIVOR/1 series hose.
- (a) Individually Order Insert **6040-0612** (6000 Series). See JIC 6000 Series Inserts on page 251.  
Order Ferrule **K000-06**.  
K000 Series Ferrules are used on SURVIVOR/1 hose; see table on previous page.  
Dash Size -06 part of **K000-06** comes from 3/8" hose =  $6/16" = -06$ ; or from the tables.
- (b) Complete Coupling Order **K040-0612**.  
Simply replace the first character of the Insert part number with the first character of the Ferrule part number. (replace 6 with K) = **6040-0612 »» K040-0612**

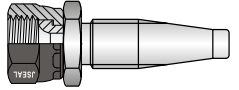
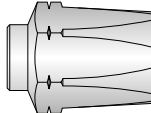
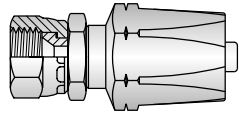
6040-0612 Insert	plus K000-06 Ferrule equals	K040-0612 complete Coupling
		

\* See page 342 for How To Order Ryco V000 Series Field Attachable Couplings for SURVIVOR/R5 and T5 Series Hose.

### CUT-OFF ALLOWANCE (CA) DIMENSIONS FOR FIELD ATTACHABLES

Due to differences in Ferrule design, many Cut-Off Allowance (CA) dimensions vary between each Ferrule Series for the same matched Insert/Hose size.

The Cut-Off Allowance (CA) dimensions published in "6000 Series Field Attachable Inserts" section allow for the Ferrule being eased back 5/8 of a turn after the hose has bottomed in the ferrule, as per "Field Attachable Assembly Instructions" (ease back between 1/2 and 3/4 of a turn).

The Cut-Off Allowance (CA) values for 6000 Series Inserts, published in the tables on pages 220 to 278 are:  
Up to and including -20 Size; the CA is for **L000** Series (the most popular series)

To determine the correct Cut-Off Allowance (CA) for other Ferrule Series, use the published figure from pages 220 to 278, and adjust by the CA Adjustment dimension listed in the table on the previous page.

- EXAMPLE:** Determine the Cut-Off Allowance (CA) for **K090-0808**.  
From table on page 108, Cut-Off Allowance (CA) for **6090-0808** (L090-0808) is 42 mm.  
From the table on the previous page, adjustment for **K000** Series in -08 size is "add 3 mm".  
**Cut-Off Allowance (CA) for K090-0808 = 42 mm + 3 mm = 45 mm.**

If the hose assembly length is critical, when calculating the Cut Length of hose, you must also allow for an increase in length of hose when the coupling is attached, due to compression within the coupling; see page 468.

For further information about Hose Assemblies and Cut-Off Allowances (CA), refer to the 2025 Ryco Hydraulic Hose catalogue.

# FIELD ATTACHABLE COUPLINGS

## 6000 SERIES FIELD ATTACHABLE FERRULES

### K000

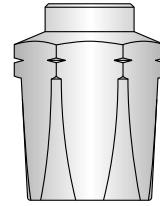

ONE WIRE BRAID  
NON-SKIVE FERRULE

PART NO.	HOSE SIZE		THREAD SIZE	TUBE SIZE	DASH SIZE	DIMENSIONS						SPANNER			
	DN	inch	inch	inch		L		C <sub>A</sub>		D <sub>L</sub>		H <sub>F</sub>		H <sub>M</sub>	
	DN	inch	inch	inch		inch	mm	inch	mm	inch	mm	inch	mm	inch	mm
K000-04	6	1/4			-04							3/4	19		
K000-06	10	3/8			-06							7/8	22		
K000-08	12	1/2			-08							1.1/16	27		
K000-10	16	5/8			-10							1.1/4	32		
K000-12	19	3/4			-12							1.3/8	35		
K000-16	25	1			-16							1.2/3			

### L000

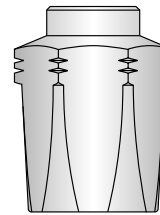

TWO WIRE BRAID  
NON-SKIVE FERRULE

PART NO.	HOSE SIZE		THREAD SIZE	TUBE SIZE	DASH SIZE	DIMENSIONS						SPANNER			
	DN	inch	inch	inch		L		C <sub>A</sub>		D <sub>L</sub>		H <sub>F</sub>		H <sub>M</sub>	
	DN	inch	inch	inch		inch	mm	inch	mm	inch	mm	inch	mm	inch	mm
L000-04	6	1/4			-04							3/4	19		
L000-06	10	3/8			-06							15/16	24		
L000-08	12	1/2			-08							1.1/8			
L000-10	16	5/8			-10							1.1/4	32		
L000-12	19	3/4			-12							1.3/8	35		
L000-16	25	1			-16							1.3/4			
L000-20	31	1.1/4			-20							2.1/4	57		

## 6000 SERIES FIELD ATTACHABLE FERRULES

### M000

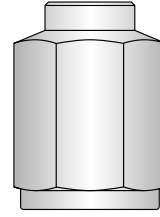

TWO TEXTILE BRAID  
FERRULE

PART NO.	HOSE SIZE		THREAD SIZE	TUBE SIZE	DASH SIZE	DIMENSIONS						SPANNER			
	DN	inch	inch	inch		L		C <sub>A</sub>		D <sub>L</sub>		H <sub>F</sub>		H <sub>M</sub>	
	DN	inch	inch	inch		inch	mm	inch	mm	inch	mm	inch	mm	inch	mm
M000-04	6	1/4			-04							3/4	19		
M000-06	10	3/8			-06							15/16	24		
M000-08	12	1/2			-08							1.1/8			
M000-12	19	3/4			-12							1.3/8	35		
M000-16	25	1			-16							1.3/4			

### P000

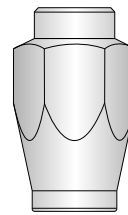

GREASELINE  
FERRULE

PART NO.	HOSE SIZE		THREAD SIZE	TUBE SIZE	DASH SIZE	DIMENSIONS						SPANNER			
	DN	inch	inch	inch		L		C <sub>A</sub>		D <sub>L</sub>		H <sub>F</sub>		H <sub>M</sub>	
	DN	inch	inch	inch		inch	mm	inch	mm	inch	mm	inch	mm	inch	mm
P000-02	4	1/8			-02								12		

### V000

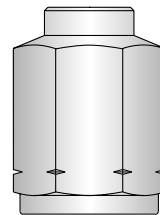

R5 FERRULE

PART NO.	HOSE SIZE		THREAD SIZE	TUBE SIZE	DASH SIZE	DIMENSIONS						SPANNER			
	DN	inch	inch	inch		L		C <sub>A</sub>		D <sub>L</sub>		H <sub>F</sub>		H <sub>M</sub>	
	DN	inch	inch	inch		inch	mm	inch	mm	inch	mm	inch	mm	inch	mm
V000-04	6	1/4			-04							5/8	16		
V000-05	8	5/16			-05							3/4	19		
V000-06	10	3/8			-06							13/16			
V000-08	12	1/2			-08							15/16	24		
V000-10	16	5/8			-10							1.1/8			
V000-12	19	3/4			-12							1.1/4	32		
V000-16	25	1			-16							1.1/2	38		
V000-20	31	1.1/4			-20							1.43/50			
V000-24	38	1.1/2			-24							2	50		
V000-32	51	2			-32							2.5/8			

# FIELD ATTACHABLE COUPLINGS

## 6000 SERIES FIELD ATTACHABLE INSERTS

BSPT

6010

BSPT MALE  
60° SEAT

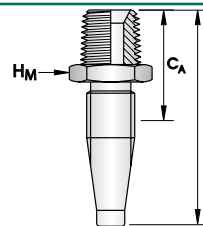

PART NO.	HOSE SIZE		THREAD SIZE	TUBE SIZE	DASH SIZE	DIMENSIONS						SPANNER			
	DN	inch	inch	inch		L		CA		DL		HF		HM	
						inch	mm	inch	mm	inch	mm	inch	mm	inch	mm
6010-0202	4	1/8	1/8"-28		-0202	1.65	42	1.02	26					7/16	11
6010-0402	6	1/4	1/8"-28		-0402	2.24	57	1.22	31					5/8	16
6010-0404	6	1/4	1/4"-19		-0404	2.44	62	1.38	35					5/8	16
6010-0406	6	1/4	3/8"-19		-0406	2.44	62	1.38	35					11/16	
6010-0504	8	5/16	1/4"-19		-0504	2.36	60	1.30	33					5/8	16
6010-0506	8	5/16	3/8"-19		-0506	2.36	60	1.30	33					11/16	
6010-0602	10	3/8	1/8"-28		-0602	2.40	61	1.10	28					11/16	
6010-0604	10	3/8	1/4"-19		-0604	2.60	66	1.26	32					11/16	
6010-0606	10	3/8	3/8"-19		-0606	2.60	66	1.26	32					11/16	
6010-0608	10	3/8	1/2"-14		-0608	2.83	72	1.50	38					7/8	22
6010-0804	12	1/2	1/4"-19		-0804	2.76	70	1.46	37					13/16	
6010-0806	12	1/2	3/8"-19		-0806	2.76	70	1.46	37					13/16	
6010-0808	12	1/2	1/2"-14		-0808	2.91	74	1.65	42					7/8	22
6010-1008	16	5/8	1/2"-14		-1008	3.19	81	1.77	45					1.1/8	
6010-1010	16	5/8	5/8"-14		-1010	3.19	81	1.77	45					1.1/8	
6010-1012	16	5/8	3/4"-14		-1012	3.19	81	1.77	45					1.1/8	
6010-1212	19	3/4	3/4"-14		-1212	3.15	80	1.65	42					1.1/16	27
6010-1216	19	3/4	1"-11		-1216	3.46	88	1.97	50					1.3/8	35
6010-1616	25	1	1"-11		-1616	3.66	93	2.17	55					1.3/8	35
6010-1820	28	1.1/8	1.1/4"-11		-1820	3.54	90	2.28	58					1.43/50	
6010-2020	31	1.1/4	1.1/4"-11		-2020	4.49	114	2.36	60					1.43/50	
6010-2424	38	1.1/2	1.1/2"-11		-2424	4.72	120	2.24	57					2.1/4	57
6010-3232	51	2	2"-11		-3232	5.39	137	2.60	66					2.1/2	

## 6000 SERIES FIELD ATTACHABLE INSERTS

**BSPP**

**6020**

**BSPP FEMALE  
60° CONE**

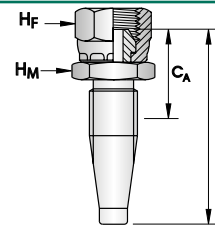

PART NO.	HOSE SIZE		THREAD SIZE	TUBE SIZE	DASH SIZE	DIMENSIONS						SPANNER			
	DN	inch	inch	inch		L		Ca		DL		Hf		Hm	
						inch	mm	inch	mm	inch	mm	inch	mm	inch	mm
6020-0202	4	1/8	1/8"-28		-0202	1.61	41	1.02	26				14	7/16	11
6020-0302	5	3/16	1/8"-28		-0302	1.81	46	0.98	25				14	5/8	16
6020-0402	6	1/4	1/8"-28		-0402	2.24	57	1.22	31				14	5/8	16
6020-0404	6	1/4	1/4"-19		-0404	2.28	58	1.22	31			3/4	19	11/16	
6020-0406	6	1/4	3/8"-19		-0406	2.36	60	1.30	33			7/8	22	11/16	
6020-0504	8	5/16	1/4"-19		-0504	2.20	56	1.14	29			3/4	19	5/8	16
6020-0506	8	5/16	3/8"-19		-0506	2.36	60	1.30	33			3/4	19	11/16	
6020-0604	10	3/8	1/4"-19		-0604	2.40	61	1.10	28			3/4	19	11/16	
6020-0606	10	3/8	3/8"-19		-0606	2.56	65	1.22	31			7/8	22	13/16	
6020-0608	10	3/8	1/2"-14		-0608	2.60	66	1.30	33			1.1/16	27	7/8	22
6020-0806	12	1/2	3/8"-19		-0806	2.64	67	1.34	34			7/8	22	13/16	
6020-0808	12	1/2	1/2"-14		-0808	2.72	69	1.42	36			1.1/16	27	1	
6020-0812	12	1/2	3/4"-14		-0812	2.72	69	1.42	36			1.1/4	32	1	
6020-1010	16	5/8	5/8"-14		-1010	2.91	74	1.50	38			1.3/16	30	1.1/8	
6020-1012	16	5/8	3/4"-14		-1012	2.99	76	1.57	40			1.1/4	32	1.1/8	
6020-1212	19	3/4	3/4"-14		-1212	2.99	76	1.50	38			1.1/4	32	1.1/4	32
6020-1216	19	3/4	1"-11		-1216	3.11	79	1.65	42			1.1/2	38	1.1/2	38
6020-1416	22	7/8	1"-11		-1416	2.64	67	1.57	40			1.1/2	38	1.1/2	38
6020-1616	25	1	1"-11		-1616	3.35	85	1.81	46			1.1/2	38	1.1/2	38
6020-1820	28	1.1/8	1.1/4"-11		-1820	3.31	84	2.01	51			2	50	1.43/50	
6020-2020	31	1.1/4	1.1/4"-11		-2020	4.21	107	2.13	54			2	50	1.43/50	
6020-2424	38	1.1/2	1.1/2"-11		-2424	4.49	114	2.01	51			2.3/16	55	2.1/4	57
6020-3232	51	2	2"-11		-3232	5.24	133	2.44	62			2.3/4	70	2.3/4	70

INTRODUCTION

INDEXES

ONE-PIECE  
COUPLINGS

PUSH-ON SUCTION &  
RETURN COUPLINGS

FIELD ATTACHABLE  
COUPLINGS

HYDRAULIC FITTINGS  
ACCESSORIES

# FIELD ATTACHABLE COUPLINGS

## 6000 SERIES FIELD ATTACHABLE INSERTS

### BSPT

### 6320

BSPT MALE SWIVEL  
160° SEAT

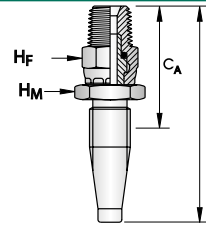

PART NO.	HOSE SIZE		THREAD SIZE	TUBE SIZE	DASH SIZE	DIMENSIONS						SPANNER			
	DN	inch	inch	inch		L		CA		DL		HF		HM	
	DN	inch	inch	inch		inch	mm	inch	mm	inch	mm	inch	mm	inch	mm
6320-0202	4	1/8	1/8" -28		-0202	1.81	46	1.18	30			1/2		1/2	
6320-0606	10	3/8	3/8" -19		-0606	3.35	85	2.01	51			7/8	22	7/8	22
6320-0608	10	3/8	1/2" -14		-0608	3.50	89	2.20	56			1		7/8	22
6320-0808	12	1/2	1/2" -14		-0808	3.62	92	2.32	59			1		7/8	22
6320-1212	19	3/4	3/4" -14		-1212	3.82	97	2.32	59			1.1/4	32	1.1/8	

### BSPT

### 6340

BSPT MALE SWIVEL  
90° ELBOW  
60° SEAT

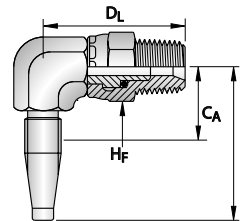

PART NO.	HOSE SIZE		THREAD SIZE	TUBE SIZE	DASH SIZE	DIMENSIONS						SPANNER			
	DN	inch	inch	inch		L		CA		DL		HF		HM	
	DN	inch	inch	inch		inch	mm	inch	mm	inch	mm	inch	mm	inch	mm
6340-0606	10	3/8	3/8" -19		-0606	2.28	58	0.98	25	1.77	45	7/8	22	3/4	19
6340-0608	10	3/8	1/2" -14		-0608	2.28	58	0.98	25	1.97	50	1		3/4	19
6340-0808	12	1/2	1/2" -14		-0808	2.56	65	1.26	32	2.05	52	1		7/8	22

### BSPP

### 6024

BSPP FEMALE  
FLAT FACE

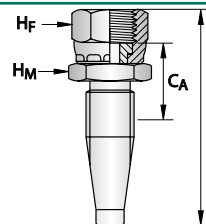

PART NO.	HOSE SIZE		THREAD SIZE	TUBE SIZE	DASH SIZE	DIMENSIONS						SPANNER			
	DN	inch	inch	inch		L		CA		DL		HF		HM	
	DN	inch	inch	inch		inch	mm	inch	mm	inch	mm	inch	mm	inch	mm
6024-0404	6	1/4	1/4" -19		-0404	2.20	56	1.14	29			3/4	19	11/16	
6024-0606	10	3/8	3/8" -19		-0606	2.44	62	1.14	29			7/8	22	13/16	
6024-0608	10	3/8	1/2" -14		-0608	2.44	62	1.14	29			1.1/16	27	7/8	22
6024-0808	12	1/2	1/2" -14		-0808	2.56	65	1.26	32			1.1/16	27	1	
6024-0812	12	1/2	3/4" -14		-0812	2.64	67	1.34	34			1.1/4	32	1	
6024-1212	19	3/4	3/4" -14		-1212	2.87	73	1.42	36			1.1/4	32	1.1/4	32

## 6000 SERIES FIELD ATTACHABLE INSERTS

<b>BSPP</b>	<b>6052</b>
-------------	-------------

**BSPP FEMALE FLAT FACE  
90° ELBOW**

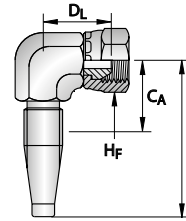

PART NO.	HOSE SIZE		THREAD SIZE	TUBE SIZE	DASH SIZE	DIMENSIONS						SPANNER			
	DN	inch	inch	inch		L		CA		DL		HF		HM	
	DN	inch	inch	inch		inch	mm	inch	mm	inch	mm	inch	mm	inch	mm
<b>6052-0608</b>	10	3/8	1/2" -14		-0608	2.32	59	1.02	26	0.94	24	1.1/16	27	7/8	22

<b>BSPP</b>	<b>6060</b>
-------------	-------------

**BSPP FEMALE  
60° CONE  
45° ELBOW**

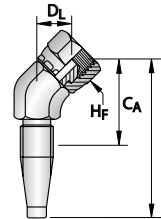

PART NO.	HOSE SIZE		THREAD SIZE	TUBE SIZE	DASH SIZE	DIMENSIONS						SPANNER			
	DN	inch	inch	inch		L		CA		DL		HF		HM	
	DN	inch	inch	inch		inch	mm	inch	mm	inch	mm	inch	mm	inch	mm
<b>6060-0404</b>	6	1/4	1/4" -19		-0404	2.68	68	1.61	41	0.59	15	3/4	19	9/16	
<b>6060-0606</b>	10	3/8	3/8" -19		-0606	2.95	75	1.65	42	0.67	17	7/8	22	3/4	19
<b>6060-0808</b>	12	1/2	1/2" -14		-0808	3.27	83	1.97	50	0.71	18	1.1/16	27	7/8	22
<b>6060-1010</b>	16	5/8	5/8" -14		-1010	3.39	86	1.97	50	0.67	17	1.3/16	30	1.1/16	27
<b>6060-1212</b>	19	3/4	3/4" -14		-1212	3.43	87	1.97	50	0.79	20	1.1/4	32	1.1/16	27
<b>6060-1616</b>	25	1	1" -11		-1616	3.90	99	2.36	60	0.83	21	1.1/2	38	1.5/16	
<b>6060-2020</b>	31	1.1/4	1.1/4" -11		-2020	4.69	119	2.56	65	0.98	25	2	50	1.7/8	

INTRODUCTION

INDEXES

ONE-PIECE COUPLINGS

PUSH-ON SUCTION & RETURN COUPLINGS

FIELD ATTACHABLE COUPLINGS

HYDRAULIC FITTINGS ACCESSORIES

# FIELD ATTACHABLE COUPLINGS

## 6000 SERIES FIELD ATTACHABLE INSERTS

**BSPP**

**6050**

BSPP FEMALE  
60° CONE  
90° ELBOW

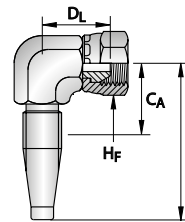

PART NO.	HOSE SIZE		THREAD SIZE	TUBE SIZE	DASH SIZE	DIMENSIONS						SPANNER			
	DN	inch	inch	inch		L		CA		DL		HF		HM	
	DN	inch	inch	inch		inch	mm	inch	mm	inch	mm	inch	mm	inch	mm
6050-0404	6	1/4	1/4" -19		-0404	2.09	53	1.02	26	0.94	24	3/4	19	9/16	
6050-0406	6	1/4	3/8" -19		-0406	2.13	54	1.06	27	1.10	28	7/8	22	3/4	19
6050-0606	10	3/8	3/8" -19		-0606	2.28	58	0.98	25	1.10	28	7/8	22	3/4	19
6050-0608	10	3/8	1/2" -14		-0608	2.32	59	1.02	26	1.22	31	1.1/16	27	7/8	22
6050-0808	12	1/2	1/2" -14		-0808	2.56	65	1.26	32	1.22	31	1.1/16	27	7/8	22
6050-1010	16	5/8	5/8" -14		-1010	2.80	71	1.34	34	1.18	30	1.3/16	30	1.1/16	27
6050-1212	19	3/4	3/4" -14		-1212	2.72	69	1.26	32	1.38	35	1.1/4	32	1.1/16	27
6050-1616	25	1	1" -11		-1616	3.15	80	1.61	41	1.57	40	1.1/2	38	1.5/16	
6050-2020	31	1.1/4	1.1/4" -11		-2020	4.49	114	2.36	60	1.85	47	2	50	1.5/8	41
6050-2424	38	1.1/2	1.1/2" -11		-2424	4.65	118	2.17	55	2.36	60	2.3/16	55	2.1/2	
6050-3232	51	2	2" -11		-3232	5.00	127	2.20	56	2.44	62	2.3/4	70	2.1/2	

**BSPP**

**6270**

BSPP FEMALE  
45° TUBE BEND  
60° SEAT

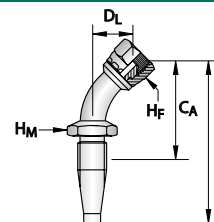

PART NO.	HOSE SIZE		THREAD SIZE	TUBE SIZE	DASH SIZE	DIMENSIONS						SPANNER			
	DN	inch	inch	inch		L		CA		DL		HF		HM	
	DN	inch	inch	inch		inch	mm	inch	mm	inch	mm	inch	mm	inch	mm
6270-0404	6	1/4	1/4" -19		-0404	2.87	73	1.85	47	0.67	17	3/4	19	5/8	16
6270-0506	8	5/16	3/8" -19		-0506	3.19	81	2.09	53	0.75	19	7/8	22	5/8	16
6270-0606	10	3/8	3/8" -19		-0606	3.35	85	2.05	52	0.71	18	7/8	22	11/16	
6270-0808	12	1/2	1/2" -14		-0808	3.74	95	2.44	62	0.87	22	1.1/16	27	13/16	
6270-1010	16	5/8	5/8" -14		-1010	4.13	105	2.72	69	0.91	23	1.3/16	30	1	
6270-1212	19	3/4	3/4" -14		-1212	4.69	119	3.23	82	1.14	29	1.1/4	32	1.1/16	27
6270-1616	25	1	1" -11		-1616	5.79	147	4.25	108	1.54	39	1.1/2	38	1.3/8	35
6270-2020	31	1.1/4	1.1/4" -11		-2020	6.93	176	4.80	122	1.73	44	2	50	1.3/4	
6270-2224	35	1.3/8	1.1/2" -11		-2224	6.46	164	5.16	131	2.05	52	2.3/16	55	2	50
6270-3232	51	2	2" -11		-3232	9.29	236	6.50	165	2.56	65	2.3/4	70	2.1/2	

## 6000 SERIES FIELD ATTACHABLE INSERTS

**BSPP**

**6260**

BSPP FEMALE  
60° CONE  
90° TUBE BEND

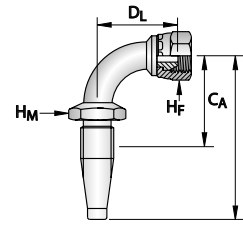

PART NO.	HOSE SIZE		THREAD SIZE	TUBE SIZE	DASH SIZE	DIMENSIONS						SPANNER			
	DN	inch	inch	inch		L		CA		DL		HF		HM	
	DN	inch	inch	inch		inch	mm	inch	mm	inch	mm	inch	mm	inch	mm
6260-0404	6	1/4	1/4" -19		-0404	2.60	66	1.54	39	1.14	29	3/4	19	5/8	16
6260-0506	8	5/16	3/8" -19		-0506	2.80	71	1.73	44	1.34	34	7/8	22	5/8	16
6260-0606	10	3/8	3/8" -19		-0606	3.03	77	1.73	44	1.30	33	7/8	22	11/16	
6260-0608	10	3/8	1/2" -14		-0608	3.03	77	1.73	44	1.30	33	1.1/16	27	3/4	19
6260-0808	12	1/2	1/2" -14		-0808	3.39	86	2.09	53	1.69	43	1.1/16	27	13/16	
6260-0810	12	1/2	5/8" -14		-0810	3.43	87	2.13	54	1.89	48	1.3/16	30	13/16	
6260-1010	16	5/8	5/8" -14		-1010	3.90	99	2.48	63	2.01	51	1.3/16	30	1	
6260-1212	19	3/4	3/4" -14		-1212	4.13	105	2.68	68	2.28	58	1.1/4	32	1.1/16	27
6260-1616	25	1	1" -11		-1616	4.80	122	3.27	83	2.87	73	1.1/2	38	1.3/8	35
6260-2020	31	1.1/4	1.1/4" -11		-2020	6.30	160	4.17	106	3.46	88	2	50	1.3/4	
6260-2224	35	1.3/8	1.1/2" -11		-2224	5.75	146	4.45	113	4.17	106	2.3/16	55	2	50
6260-3232	51	2	2" -11		-3232	8.74	222	5.98	152	5.20	132	2.3/4	70	2.1/2	

**BSPP**

**6210**

BSPP FEMALE  
60° CONE  
90° LONG TUBE BEND

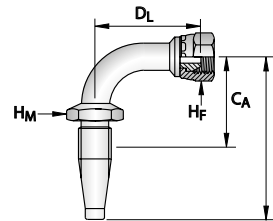

PART NO.	HOSE SIZE		THREAD SIZE	TUBE SIZE	DASH SIZE	DIMENSIONS						SPANNER			
	DN	inch	inch	inch		L		CA		DL		HF		HM	
	DN	inch	inch	inch		inch	mm	inch	mm	inch	mm	inch	mm	inch	mm
6210-0404	6	1/4	1/4" -19		-0404	2.60	66	1.54	39	1.85	47	3/4	19	5/8	16
6210-0606	10	3/8	3/8" -19		-0606	2.99	76	1.69	43	2.17	55	3/4	19	11/16	
6210-0808	12	1/2	1/2" -14		-0808	3.35	85	2.05	52	2.76	70	1.1/16	27	13/16	
6210-1010	16	5/8	5/8" -14		-1010	3.78	96	2.36	60	3.19	81	1.3/16	30	1	
6210-1212	19	3/4	3/4" -14		-1212	4.13	105	2.68	68	3.78	96	1.1/4	32	1.1/16	27
6210-1616	25	1	1" -11		-1616	4.80	122	3.27	83	4.29	109	1.1/2	38	1.3/8	35
6210-2020	31	1.1/4	1.1/4" -11		-2020	6.30	160	4.17	106	5.59	142	2	50	1.3/4	

# FIELD ATTACHABLE COUPLINGS

## 6000 SERIES FIELD ATTACHABLE INSERTS

**NPTF**

**6090**

NPTF MALE  
60° SEAT

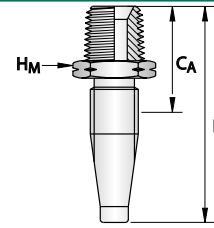

PART NO.	HOSE SIZE		THREAD SIZE	TUBE SIZE	DASH SIZE	DIMENSIONS						SPANNER			
	DN	inch	inch	inch		L		CA		DL		HF		HM	
	DN	inch	inch	inch		inch	mm	inch	mm	inch	mm	inch	mm	inch	mm
6090-0202	4	1/8	1/8" -27		-0202	1.65	42	1.02	26					5/8	16
6090-0302	5	3/16	1/8" -27		-0302	1.81	46	0.98	25					7/16	11
6090-0304	5	3/16	1/4" -18		-0304	1.97	50	1.18	30					5/8	16
6090-0402	6	1/4	1/8" -27		-0402	2.24	57	1.22	31					7/16	11
6090-0404	6	1/4	1/4" -18		-0404	2.44	62	1.38	35					5/8	16
6090-0406	6	1/4	3/8" -18		-0406	2.44	62	1.38	35					11/16	
6090-0504	8	5/16	1/4" -18		-0504	2.36	60	1.30	33					5/8	16
6090-0506	8	5/16	3/8" -18		-0506	2.44	62	1.38	35					11/16	
6090-0604	10	3/8	1/4" -18		-0604	2.60	66	1.26	32					11/16	
6090-0606	10	3/8	3/8" -18		-0606	2.60	66	1.26	32					11/16	
6090-0608	10	3/8	1/2" -14		-0608	2.83	72	1.50	38					7/8	22
6090-0806	12	1/2	3/8" -18		-0806	2.76	70	1.46	37					7/8	22
6090-0808	12	1/2	1/2" -14		-0808	2.91	74	1.65	42					7/8	22
6090-1008	16	5/8	1/2" -14		-1008	3.19	81	1.77	45					1.1/8	
6090-1012	16	5/8	3/4" -14		-1012	3.19	81	1.77	45					1.1/8	
6090-1208	19	3/4	1/2" -14		-1208	3.15	80	1.65	42					1.1/8	
6090-1212	19	3/4	3/4" -14		-1212	3.15	80	1.65	42					1.1/16	27
6090-1416	22	7/8	1" -11,5		-1416	2.99	76	1.89	48					1.3/8	35
6090-1616	25	1	1" -11,5		-1616	3.66	93	2.17	55					1.3/8	35
6090-1820	28	1.1/8	1.1/4" -11,5		-1820	3.54	90	2.28	58					1.43/50	
6090-2020	31	1.1/4	1.1/4" -11,5		-2020	4.49	114	2.36	60					1.43/50	
6090-2224	35	1.3/8	1.1/2" -11,5		-2224	3.35	85	2.01	51					2	50
6090-2424	38	1.1/2	1.1/2" -11,5		-2424	4.72	120	2.24	57					2.1/4	57
6090-3232	51	2	2" -11,5		-3232	5.39	137	2.60	66					2.1/2	

**NPTF**

**6091**

NPTF MALE EXTENDED  
60° SEAT

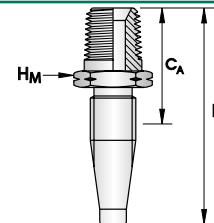

PART NO.	HOSE SIZE		THREAD SIZE	TUBE SIZE	DASH SIZE	DIMENSIONS						SPANNER			
	DN	inch	inch	inch		L		CA		DL		HF		HM	
	DN	inch	inch	inch		inch	mm	inch	mm	inch	mm	inch	mm	inch	mm
6091-0406	6	1/4	3/8" -18		-0406	2.76	70	1.69	43					3/4	19
6091-0606	10	3/8	3/8" -18		-0606	2.58	66	1.57	40						

## 6000 SERIES FIELD ATTACHABLE INSERTS

### NPSM

### 6960B

NPSM FEMALE  
LIVE SWIVEL  
60° SEAT

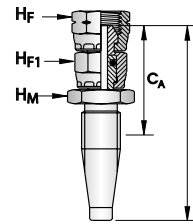

PART NO.	HOSE SIZE		THREAD SIZE	TUBE SIZE	DASH SIZE	DIMENSIONS						SPANNER			
	DN	inch	inch	inch		L		C <sub>A</sub>		D <sub>L</sub>		H <sub>F</sub>		H <sub>M</sub>	
						inch	mm	inch	mm	inch	mm	inch	mm	inch	mm
<b>6960B-0404</b>	6	1/4	1/4" -18	1/4	-0404	2.48	63	1.42	36			11/16		11/16	
<b>6960B-0604</b>	10	3/8	1/4" -18	1/4	-0604	2.60	66	1.30	33			11/16		11/16	

### GREASELINE NPTF

### 6320N

NPTF MALE SWIVEL  
60° SEAT

FOR TPGL HOSE

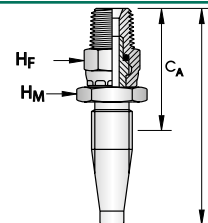

PART NO.	HOSE SIZE		THREAD SIZE	TUBE SIZE	DASH SIZE	DIMENSIONS						SPANNER			
	DN	inch	inch	inch		L		C <sub>A</sub>		D <sub>L</sub>		H <sub>F</sub>		H <sub>M</sub>	
						inch	mm	inch	mm	inch	mm	inch	mm	inch	mm
<b>6320N-0202</b>	4	1/8	1/8" -27		-0202	1.81	46	1.18	30			1/2		1/2	

INTRODUCTION

INDEXES

ONE-PIECE  
COUPLINGS

PUSH-ON SUCTION &  
RETURN COUPLINGS

FIELD ATTACHABLE  
COUPLINGS

HYDRAULIC FITTINGS  
ACCESSORIES

# FIELD ATTACHABLE COUPLINGS

## 6000 SERIES FIELD ATTACHABLE INSERTS

JIC - MALE

6030

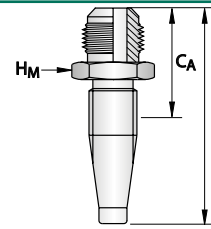

JIC  
37° CONE MALE

PART NO.	HOSE SIZE		THREAD SIZE	TUBE SIZE	DASH SIZE	DIMENSIONS						SPANNER			
	DN	inch	inch	inch		L		C <sub>A</sub>		D <sub>L</sub>		H <sub>F</sub>		H <sub>M</sub>	
						inch	mm	inch	mm	inch	mm	inch	mm	inch	mm
6030-0207	4	1/8	7/16" -20		-0207	1.89	48	1.26	32					1/2	
6030-0307	5	3/16	7/16" -20		-0307	1.97	50	1.14	29					5/8	16
6030-0407	6	1/4	7/16" -20		-0407	2.40	61	1.38	35					5/8	16
6030-0408	6	1/4	1/2" -20		-0408	2.40	61	1.38	35					5/8	16
6030-0409	6	1/4	9/16" -18		-0409	2.44	62	1.38	35					5/8	16
6030-0412	6	1/4	3/4" -16		-0412	2.60	66	1.54	39					13/16	
6030-0609	10	3/8	9/16" -18		-0609	2.56	65	1.26	32					11/16	
6030-0612	10	3/8	3/4" -16		-0612	2.72	69	1.42	36					13/16	
6030-0614	10	3/8	7/8" -14		-0614	2.83	72	1.50	38					1	
6030-0812	12	1/2	3/4" -16		-0812	2.83	72	1.54	39					13/16	
6030-0814	12	1/2	7/8" -14		-0814	2.91	74	1.61	41					15/16	24
6030-0817	12	1/2	1.1/16" -12		-0817	3.07	78	1.81	46					1.1/8	
6030-1014	16	5/8	7/8" -14		-1014	3.19	81	1.77	45					1.1/8	
6030-1017	16	5/8	1.1/16" -12		-1017	3.31	84	1.89	48					1.1/8	
6030-1217	19	3/4	1.1/16" -12		-1217	3.31	84	1.81	46					1.1/8	
6030-1219	19	3/4	1.3/16" -12		-1219	3.31	84	1.85	47					1.1/4	32
6030-1221	19	3/4	1.5/16" -12		-1221	3.43	87	1.93	49					1.3/8	35
6030-1617	25	1	1.1/16" -12		-1617	3.58	91	2.05	52					1.3/8	35
6030-1621	25	1	1.5/16" -12		-1621	3.62	92	2.09	53					1.3/8	35
6030-2026	31	1.1/4	1.5/8" -12		-2026	4.49	114	2.36	60					1.43/50	

## 6000 SERIES FIELD ATTACHABLE INSERTS

**JSEAL™ / JIC**

**6040**

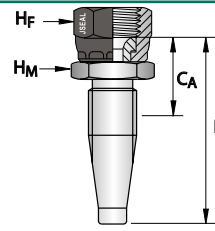

JSEAL™ / JIC FEMALE  
CONVEX SEAT

PART NO.	HOSE SIZE		THREAD SIZE	TUBE SIZE	DASH SIZE	DIMENSIONS						SPANNER			
	DN	inch	inch	inch		L		C <sub>A</sub>		D <sub>L</sub>		H <sub>F</sub>		H <sub>M</sub>	
	inch					inch	mm	inch	mm	inch	mm	inch	mm	inch	mm
6040-0207	4	1/8	7/16" -20		-0207	1.57	40	0.94	24			9/16		7/16	11
6040-0307	5	3/16	7/16" -20		-0307	1.73	44	0.91	23			9/16		9/16	
6040-0406	6	1/4	3/8" -24		-0406	2.28	58	1.26	32			1/2		1/2	
6040-0407	6	1/4	7/16" -20		-0407	2.17	55	1.14	29			9/16		5/8	16
6040-0408	6	1/4	1/2" -20		-0408	2.20	56	1.14	29			5/8	16	5/8	16
6040-0409	6	1/4	9/16" -18		-0409	2.20	56	1.14	29			11/16		11/16	
6040-0412	6	1/4	3/4" -16		-0412	2.24	57	1.22	31			7/8	22	3/4	19
6040-0509	8	5/16	9/16" -18		-0509	2.13	54	1.06	27			11/16		11/16	
6040-0607	10	3/8	7/16" -20		-0607	2.32	59	1.02	26			9/16		11/16	
6040-0608	10	3/8	1/2" -20		-0608	2.32	59	1.02	26			5/8	16	11/16	
6040-0609	10	3/8	9/16" -18		-0609	2.17	55	0.87	22			11/16		11/16	
6040-0612	10	3/8	3/4" -16		-0612	2.44	62	1.14	29			7/8	22	7/8	22
6040-0614	10	3/8	7/8" -14		-0614	2.60	66	1.30	33			1		1	
6040-0809	12	1/2	9/16" -18		-0809	2.52	64	1.22	31			11/16		13/16	
6040-0812	12	1/2	3/4" -16		-0812	2.56	65	1.26	32			7/8	22	7/8	22
6040-0814	12	1/2	7/8" -14		-0814	2.80	71	1.54	39			1		1	
6040-0817	12	1/2	1.1/16" -12		-0817	2.80	71	1.50	38			1.1/4	32	1.1/8	
6040-1014	16	5/8	7/8" -14		-1014	2.91	74	1.50	38			1		1	
6040-1017	16	5/8	1.1/16" -12		-1017	2.99	76	1.57	40			1.1/4	32	1.1/4	32
6040-1214	19	3/4	7/8" -14		-1214	2.95	75	1.50	38			1		1.1/16	27
6040-1217	19	3/4	1.1/16" -12		-1217	2.99	76	1.54	39			1.1/4	32	1.1/4	32
6040-1219	19	3/4	1.3/16" -12		-1219	2.99	76	1.50	38			1.3/8	35	1.3/8	35
6040-1221	19	3/4	1.5/16" -12		-1221	3.11	79	1.65	42			1.1/2	38	1.1/2	38
6040-1421	22	7/8	1.5/16" -12		-1421	2.64	67	1.57	40			1.1/2	38	1.1/2	38
6040-1617	25	1	1.1/16" -12		-1617	3.31	84	1.77	45			1.1/4	32	1.3/8	35
6040-1621	25	1	1.5/16" -12		-1621	3.35	85	1.81	46			1.1/2	38	1.1/2	38
6040-1626	25	1	1.5/8" -12		-1626	3.39	86	1.85	47			2	50	1.5/8	41
6040-1826	28	1.1/8	1.5/8" -12		-1826	3.39	86	2.13	54			2	50	1.43/50	
6040-2026	31	1.1/4	1.5/8" -12		-2026	4.17	106	2.05	52			2	50	1.43/50	
6040-2230	35	1.3/8	1.7/8" -12		-2230	3.07	78	1.77	45			2.1/4	57	2	50
6040-2430	38	1.1/2	1.7/8" -12		-2430	4.45	113	2.01	51			2.1/4	57	2.1/4	57
6040-2940	46	1.13/16	2.1/2" -12		-2940	3.90	99	2.13	54			2.7/8	73	2.3/4	70
6040-3240	51	2	2.1/2" -12		-3240	5.24	133	2.44	62			2.7/8	73	2.3/4	70

INTRODUCTION

INDEXES

ONE-PIECE  
COUPLINGS

PUSH-ON SUCTION &  
RETURN COUPLINGS

FIELD ATTACHABLE  
COUPLINGS

HYDRAULIC FITTINGS  
ACCESSORIES

# FIELD ATTACHABLE COUPLINGS

## 6000 SERIES FIELD ATTACHABLE INSERTS

### GREASE LINE

### 6861

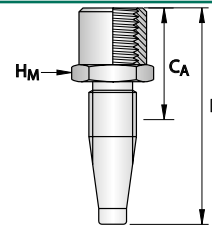

GREASE LINE FIXED FEMALE

PART NO.	HOSE SIZE		THREAD SIZE	TUBE SIZE	DASH SIZE	DIMENSIONS						SPANNER			
	DN	inch	inch	inch		L		CA		DL		HF		HM	
	DN	inch	inch	inch		inch	mm	inch	mm	inch	mm	inch	mm	inch	mm
6861-0408	6	1/4		5/16	-0408	2.32	59	1.26	32					11/16	
6861-0608	10	3/8		5/16	-0608	2.44	62	1.14	29					3/4	19

### GREASE LINE

### 6860

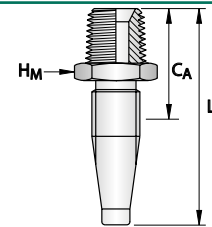

GREASE LINE MALE

PART NO.	HOSE SIZE		THREAD SIZE	TUBE SIZE	DASH SIZE	DIMENSIONS						SPANNER			
	DN	inch	inch	inch		L		CA		DL		HF		HM	
	DN	inch	inch	inch		inch	mm	inch	mm	inch	mm	inch	mm	inch	mm
6860-0408	6	1/4		5/16	-0408	2.44	62	1.38	35					11/16	

## 6000 SERIES FIELD ATTACHABLE INSERTS

### JSEAL™ / JIC

### 6080

JSEAL™ / JIC FEMALE  
CONVEX SEAT  
45° ELBOW

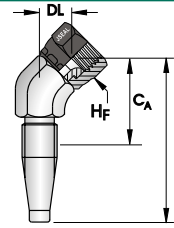

PART NO.	HOSE SIZE		THREAD SIZE	TUBE SIZE	DASH SIZE	DIMENSIONS						SPANNER			
	DN	inch	inch	mm		L		CA		DL		HF		HM	
						inch	mm	inch	mm	inch	mm	inch	mm	inch	mm
6080-0407	6	1/4	7/16" -20		-0407	2.52	64	1.46	37	0.43	11	9/16		9/16	
6080-0408	6	1/4	1/2" - 20		-0408	2.52	64	1.50	38	0.43	11	5/8	16	9/16	
6080-0409	6	1/4	9/16" -18		-0409	2.60	66	1.57	40	0.51	13	11/16		9/16	
6080-0609	10	3/8	9/16" -18		-0609	2.80	71	1.50	38	0.51	13	11/16		3/4	19
6080-0612	10	3/8	3/4" -16		-0612	2.87	73	1.57	40	0.59	15	7/8	22	3/4	19
6080-0812	12	1/2	3/4" -16		-0812	3.15	80	1.89	48	0.59	15	7/8	22	7/8	22
6080-0814	12	1/2	7/8" -14		-0814	3.23	82	1.93	49	0.67	17	1		7/8	22
6080-0817	12	1/2	1.1/16" -12		-0817	3.23	82	1.93	49	0.67	17	1.1/4	32	1.1/16	27
6080-1014	16	5/8	7/8" -14		-1014	3.35	85	1.93	49	0.63	16	1			
6080-1017	16	5/8	1.1/16" -12		-1017	3.35	85	1.93	49	0.67	17	1.1/4	32	1.1/16	27
6080-1217	19	3/4	1.1/16" -12		-1217	3.31	84	1.85	47	0.67	17	1.1/4	32	1.1/16	27
6080-1621	25	1	1.5/16" -12		-1621	3.90	99	2.36	60	0.83	21	1.1/2	38	1.5/16	
6080-2026	31	1.1/4	1.5/8" -12		-2026	4.72	120	2.60	66	0.98	25	2	50	1.5/8	41

### JSEAL™ / JIC

### 6070

JSEAL™ / JIC FEMALE  
CONVEX SEAT  
90° ELBOW

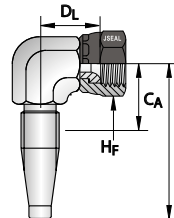

PART NO.	HOSE SIZE		THREAD SIZE	TUBE SIZE	DASH SIZE	DIMENSIONS						SPANNER			
	DN	inch	inch	mm		L		CA		DL		HF		HM	
						inch	mm	inch	mm	inch	mm	inch	mm	inch	mm
6070-0407	6	1/4	7/16" -20		-0407	2.09	53	1.02	26	0.71	18	9/16		9/16	
6070-0408	6	1/4	1/2" - 20		-0408	2.09	53	1.02	26	0.67	17	5/8	16	9/16	
6070-0409	6	1/4	9/16" -18		-0409	2.09	53	1.02	26	0.87	22	11/16		9/16	
6070-0607	10	3/8	7/16" -20		-0607	2.28	58	0.98	25	0.91	23	9/16		3/4	19
6070-0609	10	3/8	9/16" -18		-0609	2.28	58	0.98	25	0.91	23	11/16		3/4	19
6070-0612	10	3/8	3/4" -16		-0612	2.28	58	0.98	25	0.94	24	7/8	22	3/4	19
6070-0812	12	1/2	3/4" -16		-0812	2.56	65	1.26	32	1.06	27	7/8	22	7/8	22
6070-0814	12	1/2	7/8" -14		-0814	2.56	65	1.26	32	1.10	28	1		7/8	22
6070-0817	12	1/2	1.1/16" -12		-0817	2.56	65	1.26	32	1.22	31	1.1/4	32	1.1/16	27
6070-1014	16	5/8	7/8" -14		-1014	2.80	71	1.34	34	1.26	32	1		1.1/16	27
6070-1017	16	5/8	1.1/16" -12		-1017	2.72	69	1.30	33	1.26	32	1.1/4	32	1.1/16	27
6070-1217	19	3/4	1.1/16" -12		-1217	2.72	69	1.26	32	1.26	32	1.1/4	32	1.1/16	27
6070-1219	19	3/4	1.3/16" -12		-1219	2.91	74	1.46	37	1.38	35	1.3/8	35	1.5/16	
6070-1621	25	1	1.5/16" -12		-1621	3.15	80	1.61	41	1.50	38	1.1/2	38	1.5/16	
6070-2026	31	1.1/4	1.5/8" -12		-2026	4.49	114	2.36	60	1.85	47	2	50	1.5/8	41

# FIELD ATTACHABLE COUPLINGS

## 6000 SERIES FIELD ATTACHABLE INSERTS

JSEAL™ / JIC

6250

JSEAL™ / JIC FEMALE  
CONVEX SEAT  
45° TUBE BEND

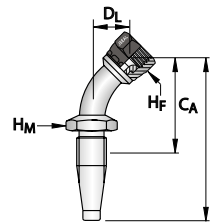

PART NO.	HOSE SIZE		THREAD SIZE	TUBE SIZE	DASH SIZE	DIMENSIONS						SPANNER			
	DN	inch	inch	mm		L		CA		DL		HF		HM	
						inch	mm	inch	mm	inch	mm	inch	mm	inch	mm
6250-0307	5	3/16	7/16" -20		-0307	2.44	62	1.61	41	0.59	15	9/16		5/8	16
6250-0407	6	1/4	7/16" -20		-0407	2.83	72	1.77	45	0.59	15	9/16		5/8	16
6250-0408	6	1/4	1/2" - 20		-0408	2.83	72	1.77	45	0.59	15	5/8	16	5/8	16
6250-0409	6	1/4	9/16" -18		-0409	2.83	72	1.77	45	0.59	15	11/16		5/8	16
6250-0509	8	5/16	9/16" -18		-0509	2.95	75	1.85	47	0.55	14	11/16		5/8	16
6250-0609	10	3/8	9/16" -18		-0609	3.15	80	1.85	47	0.55	14	11/16		11/16	
6250-0612	10	3/8	3/4" -16		-0612	3.19	81	1.89	48	0.67	17	7/8	22	11/16	
6250-0812	12	1/2	3/4" -16		-0812	3.62	92	2.32	59	0.83	21	7/8	22	13/16	
6250-0814	12	1/2	7/8" -14		-0814	3.70	94	2.40	61	0.87	22	1		13/16	
6250-1014	16	5/8	7/8" -14		-1014	4.09	104	2.68	68	0.94	24	1		1	
6250-1017	16	5/8	1.1/16" -12		-1017	4.09	104	2.68	68	0.94	24	1.1/4	32	1	
6250-1217	19	3/4	1.1/16" -12		-1217	4.72	120	3.27	83	1.10	28	1.1/4	32	1.1/16	27
6250-1219	19	3/4	1.3/16" -12		-1219	4.49	114	2.99	76	0.94	24	1.3/8	35		
6250-1221	19	3/4	1.5/16" -12		-1221	4.76	121	3.31	84	1.26	32	1.1/2	38	1.1/4	32
6250-1421	22	7/8	1.5/16" -12		-1421	4.76	121	3.70	94	1.38	35	1.1/2	38	1.3/8	35
6250-1621	25	1	1.5/16" -12		-1621	5.47	139	3.94	100	1.38	35	1.1/2	38	1.3/8	35
6250-2026	31	1.1/4	1.5/8" -12		-2026	6.81	173	4.69	119	1.54	39	2	50	1.3/4	
6250-2230	35	1.3/8	1.7/8" -12		-2230	6.46	164	5.16	131	1.97	50	2.1/4	57	2	50

## 6000 SERIES FIELD ATTACHABLE INSERTS

JSEAL™ / JIC

6240

JSEAL™ / JIC FEMALE  
CONVEX SEAT  
90° TUBE BEND

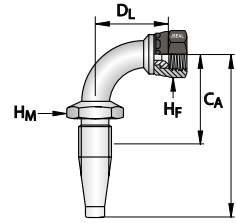

PART NO.	HOSE SIZE		THREAD SIZE	TUBE SIZE	DASH SIZE	DIMENSIONS						SPANNER			
	DN	inch	inch	mm		L		C <sub>A</sub>		D <sub>L</sub>		H <sub>F</sub>		H <sub>M</sub>	
						inch	mm	inch	mm	inch	mm	inch	mm	inch	mm
6240-0307	5	3/16	7/16" -20		-0307	2.09	53	1.30	33	1.26	32	9/16		5/8	16
6240-0407	6	1/4	7/16" -20		-0407	2.56	65	1.50	38	1.06	27	9/16		5/8	16
6240-0408	6	1/4	1/2" - 20		-0408	2.60	66	1.54	39	1.14	29	5/8	16	5/8	16
6240-0409	6	1/4	9/16" -18		-0409	2.48	63	1.42	36	1.14	29	11/16		5/8	16
6240-0509	8	5/16	9/16" -18		-0509	2.83	72	1.77	45	1.18	30	11/16		5/8	16
6240-0609	10	3/8	9/16" -18		-0609	3.03	77	1.73	44	0.98	25	11/16		11/16	
6240-0612	10	3/8	3/4" -16		-0612	3.03	77	1.73	44	1.18	30	7/8	22	11/16	
6240-0812	12	1/2	3/4" -16		-0812	3.43	87	2.13	54	1.50	38	7/8	22	13/16	
6240-0814	12	1/2	7/8" -14		-0814	3.43	87	2.13	54	1.85	47	1		13/16	
6240-1014	16	5/8	7/8" -14		-1014	3.78	96	2.36	60	1.89	48	1		1	
6240-1017	16	5/8	1.1/16" -12		-1017	3.86	98	2.44	62	1.93	49	1.1/4	32	1	
6240-1217	19	3/4	1.1/16" -12		-1217	3.98	101	2.52	64	2.24	57	1.1/4	32	1.1/16	27
6240-1221	19	3/4	1.5/16" -12		-1221	4.21	107	2.76	70	2.80	71	1.1/2	38	1.1/4	32
6240-1421	22	7/8	1.5/16" -12		-1421	4.09	104	3.03	77	2.83	72	1.1/2	38	1.3/8	35
6240-1617	25	1	1.1/16" -12		-1617	4.57	116	3.03	77	2.28	58	1.1/4	32	1.3/8	35
6240-1621	25	1	1.5/16" -12		-1621	4.84	123	3.31	84	2.83	72	1.1/2	38	1.3/8	35
6240-1826	28	1.1/8	1.5/8" -12		-1826	5.31	135	4.06	103	3.19	81	2	50	1.3/4	
6240-2026	31	1.1/4	1.5/8" -12		-2026	6.34	161	4.21	107	3.23	82	2	50	1.3/4	
6240-2230	35	1.3/8	1.7/8" -12		-2230	5.75	146	4.45	113	4.09	104	2.1/4	57	2	50

INTRODUCTION

INDEXES

ONE-PIECE COUPLINGS

PUSH-ON SUCTION & RETURN COUPLINGS

FIELD ATTACHABLE COUPLINGS

HYDRAULIC FITTINGS ACCESSORIES

# FIELD ATTACHABLE COUPLINGS

## 6000 SERIES FIELD ATTACHABLE INSERTS

JIC

6280

JSEAL™ / JIC FEMALE  
90° LONG TUBE BEND  
CONVEX SEAT

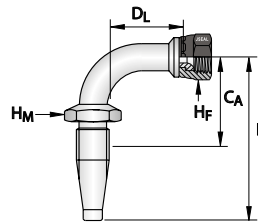

PART NO.	HOSE SIZE		THREAD SIZE	TUBE SIZE	DASH SIZE	DIMENSIONS						SPANNER			
	DN	inch	inch	mm		L		C <sub>A</sub>		D <sub>L</sub>		H <sub>F</sub>		H <sub>M</sub>	
	DN	inch	inch	mm		inch	mm	inch	mm	inch	mm	inch	mm	inch	mm
6280-0407	6	1/4	7/16" -20		-0407	2.76	70	1.69	43	1.85	47	9/16		5/8	16
6280-0408	6	1/4	1/2" - 20		-0408	2.60	66	1.54	39	1.85	47	5/8	16	5/8	16
6280-0409	6	1/4	9/16" -18		-0409	2.60	66	1.54	39	2.13	54	11/16		5/8	16
6280-0509	8	5/16	9/16" -18		-0509	2.95	75	1.89	48	2.17	55	11/16		5/8	16
6280-0609	10	3/8	9/16" -18		-0609	2.91	74	1.61	41	2.17	55	11/16		11/16	
6280-0612	10	3/8	3/4" -16		-0612	3.03	77	1.73	44	2.52	64	7/8	22	11/16	
6280-0812	12	1/2	3/4" -16		-0812	3.39	86	2.09	53	2.36	60	7/8	22	13/16	
6280-0814	12	1/2	7/8" -14		-0814	3.39	86	2.09	53	2.76	70	1		13/16	
6280-1014	16	5/8	7/8" -14		-1014	3.86	98	2.44	62	2.76	70	1		1	
6280-1017	16	5/8	1.1/16" -12		-1017	3.86	98	2.44	62	3.78	96	1.1/4	32	1	
6280-1217	19	3/4	1.1/16" -12		-1217	4.13	105	2.68	68	3.78	96	1.1/4	32	1.1/16	27
6280-1621	25	1	1.5/16" -12		-1621	5.12	130	3.58	91	4.49	114	1.1/2	38	1.3/8	35
6280-2026	31	1.1/4	1.5/8" -12		-2026	6.26	159	4.13	105	5.08	129	2	50	1.3/4	
6280-2430	38	1.1/2	1.7/8" -12		-2430	7.24	184	4.76	121	5.55	141	2.1/4	57	2.1/4	57

JIS - METRIC

6680

METRIC FEMALE  
60° CONCAVE SEAT (JIS)

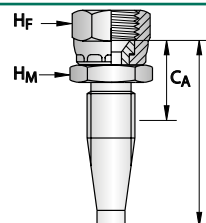

PART NO.	HOSE SIZE		THREAD SIZE	TUBE SIZE	DASH SIZE	DIMENSIONS						SPANNER			
	DN	inch	mm	mm		L		C <sub>A</sub>		D <sub>L</sub>		H <sub>F</sub>		H <sub>M</sub>	
	DN	inch	mm	mm		inch	mm	inch	mm	inch	mm	inch	mm	inch	mm
6680-0618	10	3/8	M 18X1,5		-0618	2.40	61	1.06	27			7/8	22	3/4	19

## 6000 SERIES FIELD ATTACHABLE INSERTS

### METRIC - DKL

### 6650

#### DKL MALE 24° SEAT

RYCO DKL FEMALE SWIVELS UP TO M26 SIZE HAVE MULTISEAL DKL 24° AND DKM 60° CONE. M30 AND OVER HAVE DKL 24° CONE ONLY.

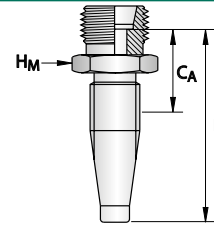

PART NO.	HOSE SIZE		THREAD SIZE	TUBE SIZE	DASH SIZE	DIMENSIONS				SPANNER					
	DN	inch	mm	mm		L		CA		DL		HF		HM	
						inch	mm	inch	mm	inch	mm	inch	mm	inch	mm
<b>6650-0412</b>	6	1/4	M 12X1,5	6	-0412	2.24	57	1.22	31						17
<b>6650-0414</b>	6	1/4	M 14X1,5	8	-0414	2.24	57	1.22	31						17
<b>6650-0616</b>	10	3/8	M 16X1,5	10	-0616	2.44	62	1.10	28					3/4	19
<b>6650-0618</b>	10	3/8	M 18X1,5	12	-0618	2.44	62	1.10	28					3/4	19
<b>6650-0818</b>	12	1/2	M 18X1,5	12	-0818	2.60	66	1.30	33					7/8	22
<b>6650-0822</b>	12	1/2	M 22X1,5	15	-0822	2.64	67	1.34	34					15/16	24
<b>6650-0826</b>	12	1/2	M 26X1,5	18	-0826	2.64	67	1.34	34					1.1/16	27
<b>6650-1026</b>	16	5/8	M 26X1,5	18	-1026	2.83	72	1.42	36					1.1/16	27
<b>6650-1230</b>	19	3/4	M 30X2	22	-1230	2.99	76	1.50	38					1.1/4	32
<b>6650-1636</b>	25	1	M 36X2	28	-1636	3.19	81	1.69	43					1.5/8	41

### METRIC - DKL

### 6600

#### DKL FEMALE 24° / 60° CONE

RYCO DKL FEMALE SWIVELS UP TO M26 SIZE HAVE MULTISEAL DKL 24° AND DKM 60° CONE. M30 AND OVER HAVE DKL 24° CONE ONLY.

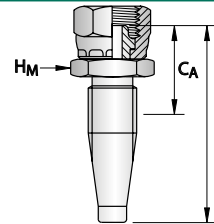

PART NO.	HOSE SIZE		THREAD SIZE	TUBE SIZE	DASH SIZE	DIMENSIONS				SPANNER					
	DN	inch	mm	mm		L		CA		DL		HF		HM	
						inch	mm	inch	mm	inch	mm	inch	mm	inch	mm
<b>6600-0412</b>	6	1/4	M 12X1,5	6	-0412	2.36	60	1.34	34				14		17
<b>6600-0414</b>	6	1/4	M 14X1,5	8	-0414	2.36	60	1.34	34				17		17
<b>6600-0416</b>	6	1/4	M 16X1,5	10	-0416	2.44	62	1.38	35			3/4	19		17
<b>6600-0616</b>	10	3/8	M 16X1,5	10	-0616	2.56	65	1.26	32			3/4	19	3/4	19
<b>6600-0618</b>	10	3/8	M 18X1,5	12	-0618	2.64	67	1.30	33			7/8	22	3/4	19
<b>6600-0822</b>	12	1/2	M 22X1,5	15	-0822	2.80	71	1.50	38			1.1/16	27	7/8	22
<b>6600-0826</b>	12	1/2	M 26X1,5	18	-0826	2.83	72	1.54	39			1.1/4	32	1.1/16	27
<b>6600-1026</b>	16	5/8	M 26X1,5	18	-1026	3.11	79	1.69	43			1.1/4	32	1.1/16	27
<b>6600-1230</b>	19	3/4	M 30X2	22	-1230	3.19	81	1.69	43				36	1.3/16	30
<b>6600-1636</b>	25	1	M 36X2	28	-1636	3.39	86	1.85	47			1.5/8	41		36

# FIELD ATTACHABLE COUPLINGS

## 6000 SERIES FIELD ATTACHABLE INSERTS

### METRIC - DKL

### 6660

DKL FEMALE  
24° / 60° CONE  
45° TUBE BEND

RYCO DKL FEMALE SWIVELS UP TO M26 SIZE HAVE MULTISEAL DKL 24° AND DKM 60° CONE. M30 AND OVER HAVE DKL 24° CONE ONLY.

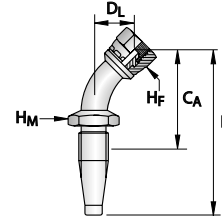

PART NO.	HOSE SIZE		THREAD SIZE	TUBE SIZE	DASH SIZE	DIMENSIONS						SPANNER			
	DN	inch	mm	mm		L		C <sub>A</sub>		D <sub>L</sub>		H <sub>F</sub>		H <sub>M</sub>	
						inch	mm	inch	mm	inch	mm	inch	mm	inch	mm
6660-0412	6	1/4	M 12X1,5	6	-0412	2.95	75	1.93	49	0.71	18		14		17
6660-0414	6	1/4	M 14X1,5	8	-0414	2.95	75	1.89	48	0.67	17		17		17
6660-0616	10	3/8	M 16X1,5	10	-0616	3.43	87	2.09	53	0.79	20	3/4	19	3/4	19
6660-0618	10	3/8	M 18X1,5	12	-0618	3.43	87	2.09	53	0.79	20	7/8	22	3/4	19
6660-0822	12	1/2	M 22X1,5	15	-0822	3.86	98	2.56	65	0.87	22	1.1/16	27	7/8	22
6660-0826	12	1/2	M 26X1,5	18	-0826	3.94	100	2.64	67	0.91	23	1.1/4	32	1.1/16	27
6660-1026	16	5/8	M 26X1,5	18	-1026	4.25	108	2.83	72	1.10	28	1.1/4	32	1.1/16	27
6660-1230	19	3/4	M 30X2	22	-1230	4.80	122	3.35	85	1.18	30		36	1.3/16	30
6660-1636	25	1	M 36X2	28	-1636	5.47	139	3.94	100	1.50	38	1.5/8	41		36

### METRIC - DKL

### 6670

DKL FEMALE  
24° / 60° CONE  
90° TUBE BEND

RYCO DKL FEMALE SWIVELS UP TO M26 SIZE HAVE MULTISEAL DKL 24° AND DKM 60° CONE. M30 AND OVER HAVE DKL 24° CONE ONLY.

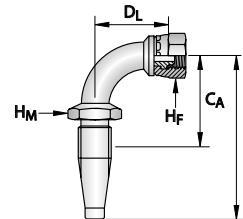

PART NO.	HOSE SIZE		THREAD SIZE	TUBE SIZE	DASH SIZE	DIMENSIONS						SPANNER			
	DN	inch	mm	mm		L		C <sub>A</sub>		D <sub>L</sub>		H <sub>F</sub>		H <sub>M</sub>	
						inch	mm	inch	mm	inch	mm	inch	mm	inch	mm
6670-0412	6	1/4	M 12X1,5	6	-0412	2.60	66	1.54	39	1.22	31		14		17
6670-0414	6	1/4	M 14X1,5	8	-0414	2.60	66	1.54	39	1.22	31		17		17
6670-0616	10	3/8	M 16X1,5	10	-0616	3.03	77	1.73	44	1.38	35	3/4	19	3/4	19
6670-0618	10	3/8	M 18X1,5	12	-0618	3.03	77	1.73	44	1.38	35	7/8	22	3/4	19
6670-0822	12	1/2	M 22X1,5	15	-0822	3.43	87	2.13	54	1.73	44	1.1/16	27	7/8	22
6670-0826	12	1/2	M 26X1,5	18	-0826	3.50	89	2.20	56	2.09	53	1.1/4	32	1.1/16	27
6670-1026	16	5/8	M 26X1,5	18	-1026	3.86	98	2.44	62	2.09	53	1.1/4	32	1.1/16	27
6670-1230	19	3/4	M 30X2	22	-1230	4.25	108	2.80	71	2.52	64		36	1.3/16	30
6670-1636	25	1	M 36X2	28	-1636	4.88	124	3.35	85	2.83	72	1.5/8	41		36

## 6000 SERIES FIELD ATTACHABLE INSERTS

### METRIC - DKS

### 6630

DKS MALE  
24° SEAT

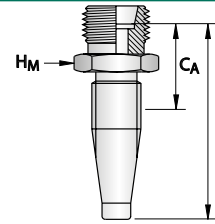

PART NO.	HOSE SIZE		THREAD SIZE	TUBE SIZE	DASH SIZE	DIMENSIONS				SPANNER					
	DN	inch	mm	mm		L		C <sub>A</sub>		D <sub>L</sub>		H <sub>F</sub>		H <sub>M</sub>	
						inch	mm	inch	mm	inch	mm	inch	mm	inch	mm
<b>6630-0416</b>	6	1/4	M 16X1,5	8	-0416	2.32	59	1.30	33						17
<b>6630-0418</b>	6	1/4	M 18X1,5	10	-0418	2.32	59	1.30	33					3/4	19
<b>6630-0620</b>	10	3/8	M 20X1,5	12	-0620	2.52	64	1.22	31					7/8	22
<b>6630-0622</b>	10	3/8	M 22X1,5	14	-0622	2.60	66	1.30	33					15/16	24
<b>6630-0824</b>	12	1/2	M 24X1,5	16	-0824	2.72	69	1.42	36					1.1/16	27
<b>6630-1230</b>	19	3/4	M 30X2	20	-1230	3.07	78	1.57	40					1.1/4	32
<b>6630-1236</b>	19	3/4	M 36X2	25	-1236	3.23	82	1.73	44					1.5/8	41
<b>6630-1642</b>	25	1	M 42X2	30	-1642	3.43	87	1.93	49						46

### METRIC - DKOS

### 6711

DKOS FEMALE  
24° CONE

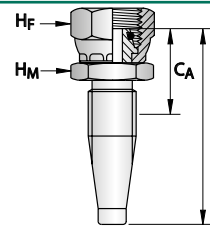

PART NO.	HOSE SIZE		THREAD SIZE	TUBE SIZE	DASH SIZE	DIMENSIONS				SPANNER					
	DN	inch	mm	mm		L		C <sub>A</sub>		D <sub>L</sub>		H <sub>F</sub>		H <sub>M</sub>	
						inch	mm	inch	mm	inch	mm	inch	mm	inch	mm
<b>6711-0416</b>	6	1/4	M 16X1,5	8	-0416	2.40	61	1.34	34			3/4	19		17
<b>6711-0418</b>	6	1/4	M 18X1,5	10	-0418	2.40	61	1.34	34			7/8	22		17
<b>6711-0620</b>	10	3/8	M 20X1,5	12	-0620	2.60	66	1.26	32			15/16	24	3/4	19
<b>6711-0622</b>	10	3/8	M 22X1,5	14	-0622	2.76	70	1.42	36			1.1/16	27		20
<b>6711-0824</b>	12	1/2	M 24X1,5	16	-0824	2.87	73	1.61	41			1.3/16	30	7/8	22
<b>6711-1230</b>	19	3/4	M 30X2	20	-1230	3.19	81	1.73	44				36		28
<b>6711-1236</b>	19	3/4	M 36X2	25	-1236	3.35	85	1.89	48			1.5/8	41	1.3/8	35

INTRODUCTION

INDEXES

ONE-PIECE COUPLINGS

PUSH-ON SUCTION & RETURN COUPLINGS

FIELD ATTACHABLE COUPLINGS

HYDRAULIC FITTINGS ACCESSORIES

# FIELD ATTACHABLE COUPLINGS

## 6000 SERIES FIELD ATTACHABLE INSERTS

### METRIC - DKOS

### 6720

DKOS FEMALE  
24° CONE  
45° TUBE BEND

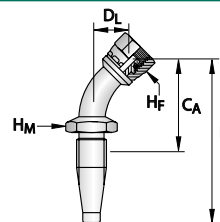

PART NO.	HOSE SIZE		THREAD SIZE	TUBE SIZE	DASH SIZE	DIMENSIONS						SPANNER			
	DN	inch	mm	mm		L		C <sub>A</sub>		D <sub>L</sub>		H <sub>F</sub>		H <sub>M</sub>	
	DN	inch	mm	mm		inch	mm	inch	mm	inch	mm	inch	mm	inch	mm
6720-0416	6	1/4	M 16X1,5	8	-0416	2.95	75	1.89	48	0.71	18	3/4	19		17
6720-0418	6	1/4	M 18X1,5	10	-0418	2.91	74	1.85	47	0.67	17	7/8	22		17
6720-0620	10	3/8	M 20X1,5	12	-0620	3.46	88	2.17	55	0.79	20	15/16	24	3/4	19
6720-0622	10	3/8	M 22X1,5	14	-0622	3.50	89	2.20	56	0.75	19	1.1/16	27		20
6720-0824	12	1/2	M 24X1,5	16	-0824	3.94	100	2.64	67	0.94	24	1.3/16	30	7/8	22
6720-1230	19	3/4	M 30X2	20	-1230	4.88	124	3.43	87	1.38	35		36		28
6720-1236	19	3/4	M 36X2	25	-1236	5.08	129	3.62	92	1.38	35	1.5/8	41	1.3/8	35

### METRIC - DKOS

### 6730

DKOS FEMALE  
24° CONE  
90° TUBE BEND

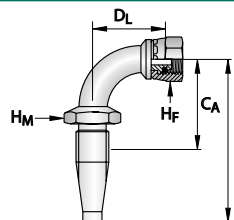

PART NO.	HOSE SIZE		THREAD SIZE	TUBE SIZE	DASH SIZE	DIMENSIONS						SPANNER			
	DN	inch	mm	mm		L		C <sub>A</sub>		D <sub>L</sub>		H <sub>F</sub>		H <sub>M</sub>	
	DN	inch	mm	mm		inch	mm	inch	mm	inch	mm	inch	mm	inch	mm
6730-0416	6	1/4	M 16X1,5	8	-0416	2.60	66	1.54	39	1.22	31	3/4	19		17
6730-0418	6	1/4	M 18X1,5	10	-0418	2.60	66	1.54	39	1.18	30	7/8	22		17
6730-0620	10	3/8	M 20X1,5	12	-0620	3.07	78	1.77	45	1.42	36	15/16	24	3/4	19
6730-0622	10	3/8	M 22X1,5	14	-0622	3.07	78	1.77	45	1.46	37	1.1/16	27		20
6730-0824	12	1/2	M 24X1,5	16	-0824	3.43	87	2.13	54	1.89	48	1.3/16	30	7/8	22
6730-1230	19	3/4	M 30X2	20	-1230	4.13	105	2.68	68	2.64	67		36		28
6730-1236	19	3/4	M 36X2	25	-1236	4.13	105	2.68	68	2.64	67	1.5/8	41	1.3/8	35

## 6000 SERIES FIELD ATTACHABLE INSERTS

### ORFS

### 6800

ORFS FEMALE

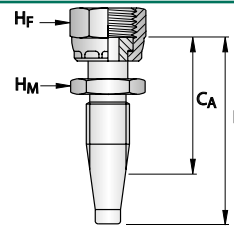

PART NO.	HOSE SIZE		THREAD SIZE	TUBE SIZE	DASH SIZE	DIMENSIONS						SPANNER			
	DN	inch	inch	inch		L		Ca		Dl		Hf		Hm	
						inch	mm	inch	mm	inch	mm	inch	mm	inch	mm
6800-0309	5	3/16	9/16" - 18		-0309	2.09	53	1.26	32			11/16		5/8	16
6800-0409	6	1/4	9/16" - 18		-0409	2.52	64	1.50	38			11/16		5/8	16
6800-0411	6	1/4	11/16" - 16		-0411	2.60	66	1.57	40			13/16		11/16	
6800-0511	8	5/16	11/16" - 16		-0511	2.56	65	1.46	37			13/16		5/8	16
6800-0611	10	3/8	11/16" - 16		-0611	2.76	70	1.42	36			13/16		11/16	
6800-0613	10	3/8	13/16" - 16		-0613	2.87	73	1.54	39			15/16	24	13/16	
6800-0813	12	1/2	13/16" - 16		-0813	2.91	74	1.61	41			15/16	24	13/16	
6800-0816	12	1/2	1" - 14		-0816	3.11	79	1.85	47			1.1/8		15/16	24
6800-1016	16	5/8	1" - 14		-1016	3.35	85	1.93	49			1.1/8		1.1/8	
6800-1019	16	5/8	1.3/16" - 12		-1019	3.46	88	2.05	52			1.3/8	35	1.1/8	
6800-1219	19	3/4	1.3/16" - 12		-1219	3.46	88	1.97	50			1.3/8	35	1.1/8	
6800-1223	19	3/4	1.7/16" - 12		-1223	3.86	98	2.40	61			1.5/8	41	1.3/8	35
6800-1423	22	7/8	1.7/16" - 12		-1423	3.39	86	2.32	59			1.5/8	41	1.3/8	35
6800-1623	25	1	1.7/16" - 12		-1623	4.09	104	2.56	65			1.5/8	41	1.3/8	35
6800-2027	31	1.1/4	1.11/16" - 12		-2027	4.96	126	2.83	72			1.7/8		1.43/50	

### ORFS

### 6810

ORFS FEMALE  
45° TUBE BEND

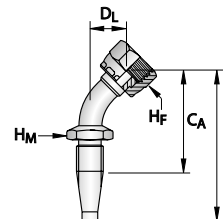

PART NO.	HOSE SIZE		THREAD SIZE	TUBE SIZE	DASH SIZE	DIMENSIONS						SPANNER			
	DN	inch	inch	inch		L		Ca		Dl		Hf		Hm	
						inch	mm	inch	mm	inch	mm	inch	mm	inch	mm
6810-0309	5	3/16	9/16" - 18		-0309	2.60	66	1.81	46	0.71	18	11/16		5/8	16
6810-0409	6	1/4	9/16" - 18		-0409	3.07	78	2.01	51	0.71	18	11/16		5/8	16
6810-0411	6	1/4	11/16" - 16		-0411	3.07	78	2.01	51	0.75	19	13/16		5/8	16
6810-0511	8	5/16	11/16" - 16		-0511	3.23	82	2.13	54	0.79	20	13/16		5/8	16
6810-0611	10	3/8	11/16" - 16		-0611	3.43	87	2.09	53	0.79	20	13/16		11/16	
6810-0613	10	3/8	13/16" - 16		-0613	3.23	82	1.93	49	0.67	17	15/16	24	3/4	19
6810-0813	12	1/2	13/16" - 16		-0813	3.66	93	2.36	60	0.75	19	15/16	24	13/16	
6810-0816	12	1/2	1" - 14		-0816	3.78	96	2.48	63	0.75	19	1.1/8		15/16	24
6810-1016	16	5/8	1" - 14		-1016	4.29	109	2.87	73	0.79	20	1.1/8		1	
6810-1019	16	5/8	1.3/16" - 12		-1019	4.41	112	2.99	76	0.94	24	1.3/8	35	1.1/8	
6810-1219	19	3/4	1.3/16" - 12		-1219	4.49	114	2.99	76	1.14	29	1.3/8	35	1.1/8	
6810-1223	19	3/4	1.7/16" - 12		-1223	4.53	115	3.03	77	1.02	26	1.5/8	41	1.3/8	35
6810-1423	22	7/8	1.7/16" - 12		-1423	4.80	122	3.74	95	1.34	34	1.5/8	41	1.3/8	35
6810-1623	25	1	1.7/16" - 12		-1623	5.51	140	3.98	101	1.34	34	1.5/8	41	1.3/8	35

# FIELD ATTACHABLE COUPLINGS

## 6000 SERIES FIELD ATTACHABLE INSERTS

### ORFS

### 6820

ORFS FEMALE  
90° MEDIUM TUBE BEND

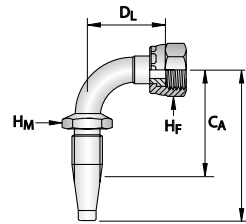

PART NO.	HOSE SIZE		THREAD SIZE	TUBE SIZE	DASH SIZE	DIMENSIONS						SPANNER			
	DN	inch	inch	inch		L		CA		DL		HF		HM	
						inch	mm	inch	mm	inch	mm	inch	mm	inch	mm
6820-0309	5	3/16	9/16" - 18		-0309	2.17	55	1.38	35	1.26	32	11/16		5/8	16
6820-0409	6	1/4	9/16" - 18		-0409	2.64	67	1.57	40	1.26	32	11/16		5/8	16
6820-0411	6	1/4	11/16" - 16		-0411	2.64	67	1.57	40	1.50	38	13/16		5/8	16
6820-0511	8	5/16	11/16" - 16		-0511	2.80	71	1.73	44	1.46	37	13/16		5/8	16
6820-0611	10	3/8	11/16" - 16		-0611	2.99	76	1.69	43	1.50	38	13/16		11/16	
6820-0613	10	3/8	13/16" - 16		-0613	2.99	76	1.69	43	1.61	41	15/16	24	3/4	19
6820-0813	12	1/2	13/16" - 16		-0813	3.35	85	2.05	52	1.61	41	15/16	24	13/16	
6820-0816	12	1/2	1" - 14		-0816	3.46	88	2.17	55	1.85	47	1.1/8		15/16	24
6820-1016	16	5/8	1" - 14		-1016	3.82	97	2.40	61	1.85	47	1.1/8		1	
6820-1019	16	5/8	1.3/16" - 12		-1019	3.94	100	2.52	64	2.28	58	1.3/8	35	1.1/8	
6820-1219	19	3/4	1.3/16" - 12		-1219	4.06	103	2.60	66	2.32	59	1.3/8	35	1.1/8	
6820-1223	19	3/4	1.7/16" - 12		-1223	4.25	108	2.80	71	2.80	71	1.5/8	41	1.3/8	35
6820-1423	22	7/8	1.7/16" - 12		-1423	4.17	106	3.11	79	2.80	71	1.5/8	41	1.3/8	35
6820-1623	25	1	1.7/16" - 12		-1623	4.88	124	3.35	85	2.80	71	1.5/8	41	1.3/8	35
6820-2027	31	1.1/4	1.11/16" - 12		-2027	6.30	160	4.17	106	3.54	90	1.7/8		1.3/4	

### ORFS

### 6830

ORFS FEMALE  
90° LONG TUBE BEND

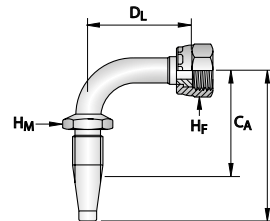

PART NO.	HOSE SIZE		THREAD SIZE	TUBE SIZE	DASH SIZE	DIMENSIONS						SPANNER			
	DN	inch	inch	inch		L		CA		DL		HF		HM	
						inch	mm	inch	mm	inch	mm	inch	mm	inch	mm
6830-0309	5	3/16	9/16" - 18		-0309	2.20	56	1.38	35	1.85	47	11/16		5/8	16
6830-0409	6	1/4	9/16" - 18		-0409	2.64	67	1.61	41	1.85	47	11/16		5/8	16
6830-0411	6	1/4	11/16" - 16		-0411	2.64	67	1.57	40	2.13	54	13/16		5/8	16
6830-0511	8	5/16	11/16" - 16		-0511	2.72	69	1.61	41	2.13	54	13/16		5/8	16
6830-0611	10	3/8	11/16" - 16		-0611	2.91	74	1.61	41	2.13	54	13/16		11/16	
6830-0613	10	3/8	13/16" - 16		-0613	2.91	74	1.61	41	2.52	64	15/16	24	3/4	19
6830-0813	12	1/2	13/16" - 16		-0813	3.39	86	2.09	53	2.56	65	15/16	24	13/16	
6830-0816	12	1/2	1" - 14		-0816	3.58	91	2.28	58	2.76	70	1.1/8		15/16	24
6830-1016	16	5/8	1" - 14		-1016	3.98	101	2.56	65	2.76	70	1.1/8		1	
6830-1019	16	5/8	1.3/16" - 12		-1019	3.90	99	2.48	63	3.78	96	1.3/8	35	1.1/8	
6830-1219	19	3/4	1.3/16" - 12		-1219	4.25	108	2.80	71	3.78	96	1.3/8	35	1.1/8	
6830-1223	19	3/4	1.7/16" - 12		-1223	4.21	107	2.76	70	4.49	114	1.5/8	41	1.3/8	35
6830-1423	22	7/8	1.7/16" - 12		-1423	4.49	114	3.43	87	4.45	113	1.5/8	41	1.3/8	35
6830-1623	25	1	1.7/16" - 12		-1623	5.20	132	3.66	93	4.45	113	1.5/8	41	1.3/8	35
6830-2027	31	1.1/4	1.11/16" - 12		-2027	6.30	160	4.17	106	5.08	129	1.7/8		1.3/4	

## 6000 SERIES FIELD ATTACHABLE INSERTS

### SAE 6530

SAE MALE  
45° CONE

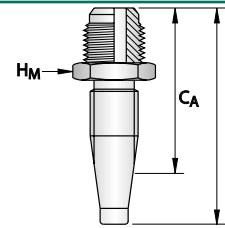

PART NO.	HOSE SIZE		THREAD SIZE	TUBE SIZE	DASH SIZE	DIMENSIONS						SPANNER			
	DN	inch	inch	inch		L		C <sub>A</sub>		D <sub>L</sub>		H <sub>F</sub>		H <sub>M</sub>	
						inch	mm	inch	mm	inch	mm	inch	mm	inch	mm
6530-0410	6	1/4	5/8" -18		-0410	2.48	63	1.46	37					11/16	
6530-0510	8	5/16	5/8" -18		-0510	2.40	61	1.34	34					5/8	16
6530-0608	10	3/8	1/2" -20		-0608	2.56	65	1.26	32					5/8	16
6530-0610	10	3/8	5/8" -18		-0610	2.60	66	1.30	33					3/4	19

### SAE 6540

SAE FEMALE  
45° FLARE

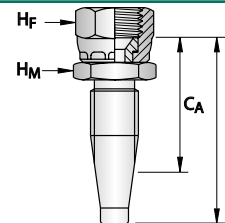

PART NO.	HOSE SIZE		THREAD SIZE	TUBE SIZE	DASH SIZE	DIMENSIONS						SPANNER			
	DN	inch	inch	inch		L		C <sub>A</sub>		D <sub>L</sub>		H <sub>F</sub>		H <sub>M</sub>	
						inch	mm	inch	mm	inch	mm	inch	mm	inch	mm
6540-0307	5	3/16	7/16" - 20		-0307	1.73	44	0.91	23			9/16		5/8	16
6540-0407	6	1/4	7/16" - 20		-0407	2.17	55	1.14	29			9/16		11/16	
6540-0408	6	1/4	1/2" -20		-0408	2.17	55	1.14	29			5/8	16	11/16	
6540-0410	6	1/4	5/8" -18		-0410	2.20	56	1.14	29			3/4	19	11/16	
6540-0510	8	5/16	5/8" -18		-0510	2.13	54	1.06	27			3/4	19	11/16	
6540-0608	10	3/8	1/2" -20		-0608	2.32	59	1.02	26			5/8	16	11/16	
6540-0610	10	3/8	5/8" -18		-0610	2.36	60	1.02	26			3/4	19	3/4	19
6540-0612	10	3/8	3/4" -16		-0612	2.44	62	1.14	29			7/8	22	7/8	22
6540-0812	12	1/2	3/4" -16		-0812	2.56	65	1.26	32			7/8	22	7/8	22
6540-0814	12	1/2	7/8" -14		-0814	2.60	66	1.30	33			1		1	
6540-1017	16	5/8	1.1/16" -12		-1017	2.91	74	1.50	38			1.1/4	32	1.1/8	
6540-1217	19	3/4	1.1/16" -12		-1217	2.91	74	1.42	36			1.1/4	32	1.1/8	

INTRODUCTION

INDEXES

ONE-PIECE COUPLINGS

PUSH-ON SUCTION & RETURN COUPLINGS

FIELD ATTACHABLE COUPLINGS

HYDRAULIC FITTINGS ACCESSORIES

# FIELD ATTACHABLE COUPLINGS

## 6000 SERIES FIELD ATTACHABLE INSERTS

SAE

6580

SAE FEMALE  
45° FLARE  
45° ELBOW

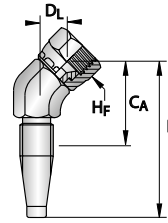

PART NO.	HOSE SIZE		THREAD SIZE	TUBE SIZE	DASH SIZE	DIMENSIONS						SPANNER			
	DN	inch	inch	inch		L		C <sub>A</sub>		D <sub>L</sub>		H <sub>F</sub>		H <sub>M</sub>	
6580-0608	10	3/8	1/2" -20		-0608	2.83	72	1.54	39	0.55	14	5/8	16	3/4	19
6580-0610	10	3/8	5/8" -18		-0610	2.87	73	1.54	39	0.59	15	3/4	19	3/4	19

SAE

6570

SAE FEMALE  
45° FLARE  
90° ELBOW

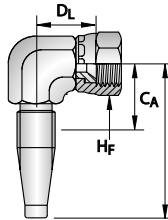

PART NO.	HOSE SIZE		THREAD SIZE	TUBE SIZE	DASH SIZE	DIMENSIONS						SPANNER			
	DN	inch	inch	inch		L		C <sub>A</sub>		D <sub>L</sub>		H <sub>F</sub>		H <sub>M</sub>	
6570-0608	10	3/8	1/2" -20		-0608	2.28	58	0.98	25	0.91	23	5/8	16	3/4	19
6570-0610	10	3/8	5/8" -18		-0610	2.28	58	0.98	25	0.91	23	3/4	19	3/4	19

SAE

6550

SAE FEMALE  
45° FLARE  
45° TUBE BEND

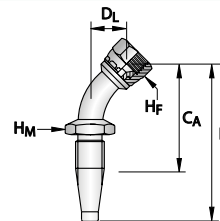

PART NO.	HOSE SIZE		THREAD SIZE	TUBE SIZE	DASH SIZE	DIMENSIONS						SPANNER			
	DN	inch	inch	inch		L		C <sub>A</sub>		D <sub>L</sub>		H <sub>F</sub>		H <sub>M</sub>	
6550-0307	5	3/16	7/16" - 20		-0307	2.36	60	1.57	40	0.59	15	9/16		5/8	16
6550-0510	8	5/16	5/8" -18		-0510	3.07	78	2.01	51	0.67	17	3/4	19	5/8	16
6550-0608	10	3/8	1/2" -20		-0608	3.23	82	1.89	48	0.59	15	5/8	16	11/16	
6550-0610	10	3/8	5/8" -18		-0610	3.27	83	1.97	50	0.67	17	3/4	19	11/16	

## 6000 SERIES FIELD ATTACHABLE INSERTS

### SAE 6560

SAE FEMALE  
45° FLARE  
90° TUBE BEND

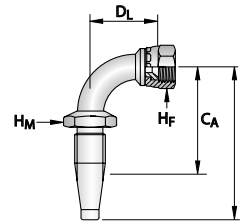

PART NO.	HOSE SIZE		THREAD SIZE	TUBE SIZE	DASH SIZE	DIMENSIONS						SPANNER			
	DN	inch	inch	inch		L		CA		DL		HF		HM	
	DN	inch	inch	inch		inch	mm	inch	mm	inch	mm	inch	mm	inch	mm
6560-0307	5	3/16	7/16" - 20		-0307	2.13	54	1.30	33	1.14	29	9/16		5/8	16
6560-0510	8	5/16	5/8" - 18		-0510	2.80	71	1.73	44	1.30	33	3/4	19	5/8	16
6560-0610	10	3/8	5/8" - 18		-0610	2.99	76	1.69	43	1.30	33	3/4	19	11/16	

### SAE 6563

SAE FEMALE  
45° FLARE  
90° LONG TUBE BEND

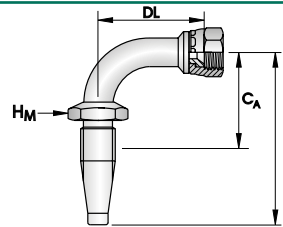

PART NO.	HOSE SIZE		THREAD SIZE	TUBE SIZE	DASH SIZE	DIMENSIONS						SPANNER			
	DN	inch	inch	inch		L		CA		DL		HF		HM	
	DN	inch	inch	inch		inch	mm	inch	mm	inch	mm	inch	mm	inch	mm
6563-0610	10	3/8	5/8" - 18		-0610	2.91	74	1.61	41	2.17	55	3/4	19	11/16	

### SAE 6740

SAE INVERTED FLARE MALE

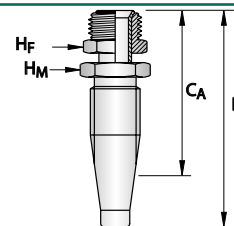

PART NO.	HOSE SIZE		THREAD SIZE	TUBE SIZE	DASH SIZE	DIMENSIONS						SPANNER			
	DN	inch	inch	inch		L		CA		DL		HF		HM	
	DN	inch	inch	inch		inch	mm	inch	mm	inch	mm	inch	mm	inch	mm
6740-0407	6	1/4	7/16" - 20		-0407	3.03	77	1.97	50			7/16	11	5/8	16
6740-0510	8	5/16	5/8" - 18		-0510	2.95	75	1.89	48			5/8	16	5/8	16
6740-0610	10	3/8	5/8" - 18		-0610	3.15	80	1.85	47			5/8	16	11/16	
6740-0611	10	3/8	11/16" - 16		-0611	3.31	84	1.97	50			11/16		11/16	

# FIELD ATTACHABLE COUPLINGS

## 6000 SERIES FIELD ATTACHABLE INSERTS

SAE

6780

SAE INVERTED FLARE MALE  
90° ELBOW

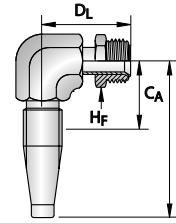

PART NO.	HOSE SIZE		THREAD SIZE	TUBE SIZE	DASH SIZE	DIMENSIONS						SPANNER			
	DN	inch	inch	inch		L		C <sub>A</sub>		D <sub>L</sub>		H <sub>F</sub>		H <sub>M</sub>	
						inch	mm	inch	mm	inch	mm	inch	mm	inch	mm
6780-0610	10	3/8	5/8" -18		-0610	2.28	58	0.98	25	1.26	32	5/8	16	3/4	19
6780-0611	10	3/8	11/16" -16		-0611	2.32	59	1.02	26	1.42	36	11/16		3/4	19

SAE

6790

SAE INVERTED FLARE MALE  
90° LONG ELBOW

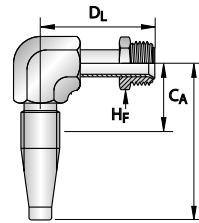

PART NO.	HOSE SIZE		THREAD SIZE	TUBE SIZE	DASH SIZE	DIMENSIONS						SPANNER			
	DN	inch	inch	inch		L		C <sub>A</sub>		D <sub>L</sub>		H <sub>F</sub>		H <sub>M</sub>	
						inch	mm	inch	mm	inch	mm	inch	mm	inch	mm
6790-0610	10	3/8	5/8" -18	-	-0610	2.28	58	0.98	25	2.36	60	5/8	16	3/4	19

SAE

6750

SAE INVERTED FLARE MALE  
45° TUBE BEND

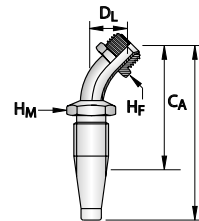

PART NO.	HOSE SIZE		THREAD SIZE	TUBE SIZE	DASH SIZE	DIMENSIONS						SPANNER			
	DN	inch	inch	inch		L		C <sub>A</sub>		D <sub>L</sub>		H <sub>F</sub>		H <sub>M</sub>	
						inch	mm	inch	mm	inch	mm	inch	mm	inch	mm
6750-0510	8	5/16	5/8" -18		-0510	4.21	107	3.15	80	0.91	23	5/8	16	5/8	16
6750-0610	10	3/8	5/8" -18		-0610	4.45	113	3.11	79	0.91	23	5/8	16	11/16	

## 6000 SERIES FIELD ATTACHABLE INSERTS

### SAE 6760

SAE INVERTED FLARE MALE  
60° TUBE BEND

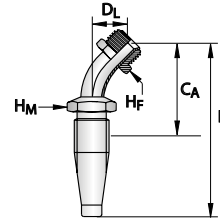

PART NO.	HOSE SIZE		THREAD SIZE	TUBE SIZE	DASH SIZE	DIMENSIONS						SPANNER			
	DN	inch	inch	inch		L		C <sub>A</sub>		D <sub>L</sub>		H <sub>F</sub>		H <sub>M</sub>	
						inch	mm	inch	mm	inch	mm	inch	mm	inch	mm
<b>6760-0407</b>	6	1/4	7/16" - 20		-0407	3.90	99	2.83	72	1.14	29	7/16	11	5/8	16

### SAE 6770

SAE INVERTED FLARE MALE  
90° TUBE BEND

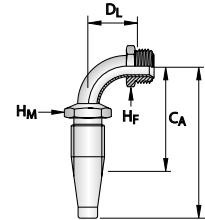

PART NO.	HOSE SIZE		THREAD SIZE	TUBE SIZE	DASH SIZE	DIMENSIONS						SPANNER			
	DN	inch	inch	inch		L		C <sub>A</sub>		D <sub>L</sub>		H <sub>F</sub>		H <sub>M</sub>	
						inch	mm	inch	mm	inch	mm	inch	mm	inch	mm
<b>6770-0407</b>	6	1/4	7/16" - 20		-0407	3.07	78	2.05	52	1.50	38	7/16	11	5/8	16
<b>6770-0510</b>	8	5/16	5/8" - 18		-0510	3.50	89	2.44	62	1.97	50	5/8	16	5/8	16
<b>6770-0610</b>	10	3/8	5/8" - 18		-0610	3.70	94	2.40	61	1.97	50	5/8	16	11/16	

INTRODUCTION

INDEXES

ONE-PIECE  
COUPLINGS

PUSH-ON SUCTION &  
RETURN COUPLINGS

FIELD ATTACHABLE  
COUPLINGS

HYDRAULIC FITTINGS  
ACCESSORIES

# FIELD ATTACHABLE COUPLINGS

## 6000 SERIES FIELD ATTACHABLE INSERTS

### DIMENSIONS FOR SAE CODE 61 AND CODE 62 FLANGES, AND RYCO CODE 62C FLANGES

NOMINAL FLANGE	CODE 61				CODE 62				CODE 62C			
	B		T		B		T		B		T	
inch	mm	inch	mm	inch	mm	inch	mm	inch	mm	inch	mm	inch
1/2	30,2	1.19	6,73	0.265	31,8	1.25	7,75	0.305				
*5/8	34,0	1.34	6,73	0.265								
3/4	38,1	1.50	6,73	0.265	41,3	1.63	8,76	0.345	41,3	1.63	14,20	0.559
1	44,5	1.75	8,00	0.315	47,6	1.88	9,53	0.375	47,6	1.88	14,20	0.559
1.1/4	50,8	2.00	8,00	0.315	54,0	2.12	10,29	0.405	54,0	2.12	14,20	0.559
1.1/2	60,3	2.38	8,00	0.315	63,5	2.50	12,57	0.495	63,5	2.50	14,20	0.559
2	71,4	2.81	9,53	0.375	79,4	3.13	12,57	0.495	79,4	3.13	14,20	0.559
2.1/2	84,1	3.31	9,53	0.375								
3	101,6	4.00	9,53	0.375								

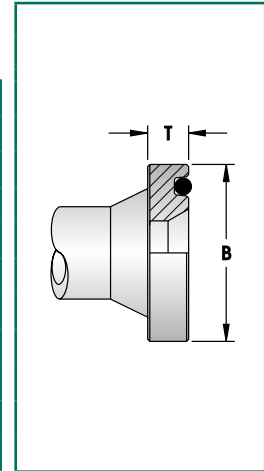

**NOTE:** Ryco Code 62C fittings conform to the flange OD and bolt hole patterns of SAE Code 62 but require special flange clamps. Ryco Code 62C flange heads are thicker than SAE Code 62 and measure T = 14,2 mm (0.559 inch) in all sizes.

### SAE FLANGE

### 6150

#### SAE CODE 61 FLANGE 45° TUBE BEND

CLAMPS - SEE PAGES 442 & 443

O RING NOT SUPPLIED

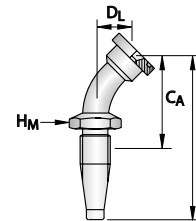

PART NO.	HOSE SIZE		THREAD SIZE	TUBE SIZE	DASH SIZE	DIMENSIONS						SPANNER			
	DN	inch	inch	inch		L		C <sub>A</sub>		D <sub>L</sub>		H <sub>F</sub>		H <sub>M</sub>	
	inch					inch	mm	inch	mm	inch	mm	inch	mm	inch	mm
<b>6150-0808</b>	12	1/2			-0808	3.74	95	2.44	62	0.79	20			13/16	
<b>6150-0812</b>	12	1/2			-0812	3.82	97	2.52	64	0.94	24			13/16	
<b>6150-1010</b>	16	5/8			-1010	4.17	106	2.76	70	0.94	24			1	
<b>6150-1212</b>	19	3/4			-1212	4.53	115	3.07	78	1.02	26			1.1/8	
<b>6150-1216</b>	19	3/4			-1216	4.69	119	3.23	82	1.18	30			1.1/8	
<b>6150-1220</b>	19	3/4			-1220	4.80	122	3.31	84	1.26	32			1.1/8	
<b>6150-1616</b>	25	1			-1616	5.35	136	3.82	97	1.18	30			1.3/8	35
<b>6150-1620</b>	25	1			-1620	5.43	138	3.90	99	1.26	32			1.3/8	35
<b>6150-1624</b>	25	1			-1624	5.51	140	3.98	101	1.30	33			1.3/8	35
<b>6150-2016</b>	31	1.1/4			-2016	6.14	156	4.02	102	1.18	30			1.43/50	
<b>6150-2020</b>	31	1.1/4			-2020	6.81	173	4.69	119	1.42	36			2	50
<b>6150-2024</b>	31	1.1/4			-2024	6.93	176	4.80	122	1.50	38			1.43/50	
<b>6150-3232</b>	51	2			-3232	9.33	237	6.57	167	2.28	58			2.3/4	70

## 6000 SERIES FIELD ATTACHABLE INSERTS

### SAE FLANGE

### 6170

**SAE CODE 61 FLANGE  
90° TUBE BEND**

O RING NOT SUPPLIED  
CLAMPS - SEE PAGES 274 & 282

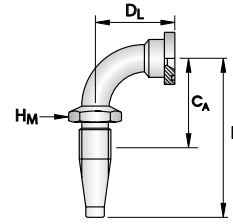

PART NO.	HOSE SIZE		THREAD SIZE	TUBE SIZE	DASH SIZE	DIMENSIONS						SPANNER			
	DN	inch	inch	inch		L		C <sub>A</sub>		D <sub>L</sub>		H <sub>F</sub>		H <sub>M</sub>	
						inch	mm	inch	mm	inch	mm	inch	mm	inch	mm
<b>6170-0808</b>	12	1/2			-0808	3.43	87	2.13	54	1.61	41			13/16	
<b>6170-0812</b>	12	1/2			-0812	3.43	87	2.13	54	1.73	44			13/16	
<b>6170-1010</b>	16	5/8			-1010	3.86	98	2.44	62	1.89	48			1	
<b>6170-1212</b>	19	3/4			-1212	4.13	105	2.68	68	2.13	54			1.1/8	
<b>6170-1216</b>	19	3/4			-1216	4.13	105	2.68	68	2.36	60			1.1/8	
<b>6170-1220</b>	19	3/4			-1220	4.13	105	2.68	68	2.44	62			1.1/8	
<b>6170-1616</b>	25	1			-1616	4.84	123	3.31	84	2.68	68			1.3/8	35
<b>6170-1620</b>	25	1			-1620	4.84	123	3.31	84	2.72	69			1.3/8	35
<b>6170-1624</b>	25	1			-1624	4.84	123	3.31	84	2.87	73			1.3/8	35
<b>6170-2016</b>	31	1.1/4			-2016	5.71	145	3.58	91	2.68	68			1.43/50	
<b>6170-2020</b>	31	1.1/4			-2020	6.34	161	4.21	107	3.03	77			1.43/50	
<b>6170-2024</b>	31	1.1/4			-2024	6.34	161	4.21	107	3.19	81			1.43/50	
<b>6170-2424</b>	38	1.1/2			-2424	7.24	184	4.76	121	3.66	93			2.1/4	57
<b>6170-2432</b>	38	1.1/2			-2432	7.24	184	4.76	121	3.90	99			2.1/4	57
<b>6170-3232</b>	51	2			-3232	8.94	227	6.18	157	4.96	126			2.3/4	70

INTRODUCTION

INDEXES

ONE-PIECE  
COUPLINGS

PUSH-ON SUCTION &  
RETURN COUPLINGS

FIELD ATTACHABLE  
COUPLINGS

HYDRAULIC FITTINGS  
ACCESSORIES

# FIELD ATTACHABLE COUPLINGS

## 6000 SERIES FIELD ATTACHABLE INSERTS

### SALVAGE

### 6230

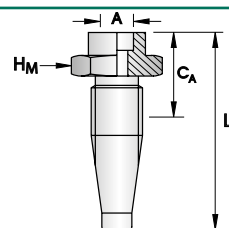

SALVAGE / LIFESAVER

PART NO.	HOSE SIZE		THREAD SIZE	TUBE SIZE	DASH SIZE	DIMENSIONS						SPANNER			
	DN	inch	inch	inch		L		C <sub>A</sub>		D <sub>L</sub>		H <sub>F</sub>		H <sub>M</sub>	
						inch	mm	inch	mm	inch	mm	inch	mm	inch	mm
6230-0304	5	3/16		1/4	-0304	1.69	43	0.87	22					5/8	16
6230-0404	6	1/4		1/4	-0404	2.13	54	1.10	28					5/8	16
6230-0406	6	1/4		3/8	-0406	2.13	54	1.10	28					5/8	16
6230-0506	8	5/16		3/8	-0506	2.09	53	0.98	25					5/8	16
6230-0606	10	3/8		3/8	-0606	2.28	58	0.94	24					11/16	
6230-0608	10	3/8		1/2	-0608	2.28	58	0.94	24					11/16	
6230-0808	12	1/2		1/2	-0808	2.44	62	1.14	29					13/16	
6230-0810	12	1/2		5/8	-0810	2.44	62	1.14	29					7/8	22
6230-0812	12	1/2		3/4	-0812	2.44	62	1.14	29					1.1/16	27
6230-1010	16	5/8		5/8	-1010	2.64	67	1.22	31					1	
6230-1012	16	5/8		3/4	-1012	2.64	67	1.22	31					1	
6230-1212	19	3/4		3/4	-1212	2.64	67	1.18	30					1.1/16	27
6230-1216	19	3/4		1	-1216	2.83	72	1.34	34					1.3/8	35
6230-1416	22	7/8		1	-1416	2.36	60	1.26	32					1.3/8	35
6230-1612	25	1		3/4	-1612	2.99	76	1.46	37					1.3/8	35
6230-1616	25	1		1	-1616	3.07	78	1.54	39					1.3/8	35
6230-1620	25	1		1.1/4	-1620	3.11	79	1.57	40					1.3/4	
6230-1820	28	1.1/8		1.1/4	-1820	2.91	74	1.61	41					1.43/50	
6230-2020	31	1.1/4		1.1/4	-2020	3.86	98	1.73	44					1.3/4	
6230-2224	35	1.3/8		1.1/2	-2224	2.64	67	1.34	34					2	50
6230-2424	38	1.1/2		1.1/2	-2424	4.06	103	1.57	40					2.1/4	57
6230-3232	51	2		2	-3232	4.76	121	1.97	50					2.1/2	

### STANDPIPE

### 6180

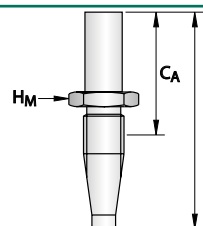

IMPERIAL STANDPIPE

PART NO.	HOSE SIZE		THREAD SIZE	TUBE SIZE	DASH SIZE	DIMENSIONS						SPANNER			
	DN	inch	inch	inch		L		C <sub>A</sub>		D <sub>L</sub>		H <sub>F</sub>		H <sub>M</sub>	
						inch	mm	inch	mm	inch	mm	inch	mm	inch	mm
6180-0405	6	1/4		5/16	-0405	2.72	69	1.69	43					5/8	16
6180-0406	6	1/4		3/8	-0406	2.76	70	1.73	44					5/8	16
6180-0606	10	3/8		3/8	-0606	2.91	74	1.57	40					5/8	16
6180-0608	10	3/8		1/2	-0608	2.91	74	1.57	40					5/8	16
6180-0808	12	1/2		1/2	-0808	3.07	78	1.77	45					13/16	
6180-0810	12	1/2		5/8	-0810	3.35	85	2.05	52					13/16	
6180-1212	19	3/4		3/4	-1212	3.78	96	2.32	59					1.1/16	27
6180-1214	19	3/4		7/8	-1214	4.06	103	2.60	66					1.1/16	27
6180-2020	31	1.1/4		1.1/4	-2020	5.31	135	3.19	81					1.3/4	

## 6000 SERIES FIELD ATTACHABLE INSERTS

### STANDPIPE

6640

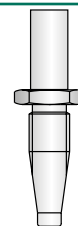

METRIC STANDPIPE

PART NO.	HOSE SIZE		THREAD SIZE	TUBE SIZE	DASH SIZE	DIMENSIONS				SPANNER					
	DN	inch	inch	inch		L		C <sub>A</sub>		D <sub>L</sub>		H <sub>F</sub>		H <sub>M</sub>	
	DN	inch	inch	inch		inch	mm	inch	mm	inch	mm	inch	mm	inch	mm
6640-0406	6	1/4		6	-0406	2.72	69	1.69	43					5/8	16
6640-0408	6	1/4		8	-0408	2.72	69	1.69	43					5/8	16
6640-0410	6	1/4		10	-0410	2.76	70	1.73	44					5/8	16
6640-0610	10	3/8		10	-0610	2.91	74	1.57	40					11/16	
6640-0612	10	3/8		12	-0612	2.91	74	1.57	40					3/4	19
6640-0614	10	3/8		14	-0614	3.15	80	1.81	46					11/16	
6640-0815	12	1/2		15	-0815	3.15	80	1.85	47					7/8	22
6640-0816	12	1/2		16	-0816	3.35	85	2.05	52					7/8	22
6640-1016	16	5/8		16	-1016	3.54	90	2.13	54					1	
6640-1220	19	3/4		20	-1220	3.86	98	2.36	60					1.1/8	
6640-1222	19	3/4		22	-1222	3.54	90	2.05	52					1.1/8	
6640-1630	25	1		30	-1630	4.45	113	2.91	74					1.3/8	35

### TUBE BITE

6850

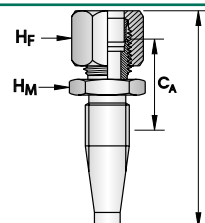

TUBE BITE

COMPLETE WITH NUT AND FLARELESS OLIVE

PART NO.	HOSE SIZE		THREAD SIZE	TUBE SIZE	DASH SIZE	DIMENSIONS				SPANNER					
	DN	inch	inch	inch		L		C <sub>A</sub>		D <sub>L</sub>		H <sub>F</sub>		H <sub>M</sub>	
	DN	inch	inch	inch		inch	mm	inch	mm	inch	mm	inch	mm	inch	mm
6850-0606	10	3/8	9/16"	3/8	-0606	2.48	63	1.14	29			11/16		3/4	19

# FIELD ATTACHABLE COUPLINGS

## 6000 SERIES FIELD ATTACHABLE INSERTS

### UNO (O RING BOSS)

**6200**

UN O RING MALE  
(O RING BOSS)

O RING SUPPLIED

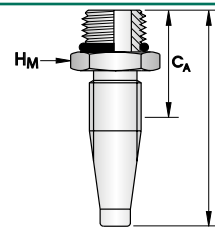

PART NO.	HOSE SIZE		THREAD SIZE	TUBE SIZE	DASH SIZE	DIMENSIONS						SPANNER			
	DN	inch	inch	inch		L		C <sub>A</sub>		D <sub>L</sub>		H <sub>F</sub>		H <sub>M</sub>	
	DN	inch	inch	inch		inch	mm	inch	mm	inch	mm	inch	mm	inch	mm
6200-0409	6	1/4	9/16" -18		-0409	2.24	57	1.22	31					11/16	
6200-0609	10	3/8	9/16" -18		-0609	2.40	61	1.06	27					3/4	19
6200-0612	10	3/8	3/4" -14		-0612	2.52	64	1.18	30					7/8	22
6200-0614	10	3/8	7/8" -14		-0614	2.56	65	1.26	32					1	
6200-0812	12	1/2	3/4" -14		-0812	2.60	66	1.30	33					7/8	22
6200-0814	12	1/2	7/8" -14		-0814	2.68	68	1.38	35					1	
6200-0817	12	1/2	1.1/16" -12		-0817	2.83	72	1.54	39					1.1/4	32
6200-1014	16	5/8	7/8" -14		-1014	3.11	79	1.69	43					1.1/8	
6200-1017	16	5/8	1.1/16" -12		-1017	3.03	77	1.61	41					1.1/4	32
6200-1021	16	5/8	1.5/16" -12		-1021	3.11	79	1.69	43					1.1/2	38
6200-1217	19	3/4	1.1/16" -12		-1217	3.03	77	1.54	39					1.1/4	32
6200-1221	19	3/4	1.5/16" -12		-1221	3.11	79	1.61	41					1.1/2	38
6200-1617	25	1	1.1/16" -12		-1617	3.50	89	1.97	50					1.1/4	32
6200-1619	25	1	1.3/16" -12		-1619	3.31	84	1.77	45					1.3/8	35
6200-1621	25	1	1.5/16" -12		-1621	3.31	84	1.77	45					1.1/2	38

### UNO (O RING BOSS)

**6380**

UN O RING MALE SWIVEL  
(O RING BOSS)

O RING SUPPLIED

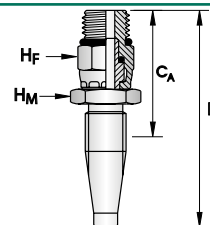

PART NO.	HOSE SIZE		THREAD SIZE	TUBE SIZE	DASH SIZE	DIMENSIONS						SPANNER			
	DN	inch	inch	inch		L		C <sub>A</sub>		D <sub>L</sub>		H <sub>F</sub>		H <sub>M</sub>	
	DN	inch	inch	inch		inch	mm	inch	mm	inch	mm	inch	mm	inch	mm
6380-0409	6	1/4	9/16" -18		-0409	2.80	71	1.77	45			11/16		11/16	
6380-0612	10	3/8	3/4" -14		-0612	3.23	82	1.89	48			7/8	22	7/8	22
6380-0814	12	1/2	7/8" -14		-0814	3.35	85	2.05	52			1		7/8	22
6380-1014	16	5/8	7/8" -14		-1014	3.54	90	2.13	54			1		1	

## 6000 SERIES FIELD ATTACHABLE INSERTS

### UNO (O RING BOSS)

### 6390

UN O RING (BOSS) MALE SWIVEL  
90° ELBOW

O RING SUPPLIED

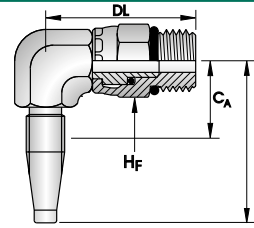

PART NO.	HOSE SIZE		THREAD SIZE	TUBE SIZE	DASH SIZE	DIMENSIONS						SPANNER			
	DN	inch	inch	inch		L		C <sub>A</sub>		D <sub>L</sub>		H <sub>F</sub>		H <sub>M</sub>	
						inch	mm	inch	mm	inch	mm	inch	mm	inch	mm
<b>6390-0409</b>	6	1/4	9/16" -18		-0409	2.09	53	1.02	26	1.38	35	11/16		9/16	
<b>6390-0412</b>	6	1/4	3/4" -14		-0412	2.17	55	1.10	28	1.65	42	7/8	22	3/4	19
<b>6390-0609</b>	10	3/8	9/16" -18		-0609	2.28	58	0.98	25	1.50	38	11/16		3/4	19
<b>6390-0612</b>	10	3/8	3/4" -14		-0612	2.28	58	0.98	25	1.65	42	7/8	22	3/4	19
<b>6390-0614</b>	10	3/8	7/8" -14		-0614	2.32	59	1.02	26	1.77	45	1		7/8	22
<b>6390-0812</b>	12	1/2	3/4" -14		-0812	2.56	65	1.26	32	1.73	44	7/8	22	7/8	22
<b>6390-0814</b>	12	1/2	7/8" -14		-0814	2.56	65	1.26	32	1.77	45	1		7/8	22

INTRODUCTION

INDEXES

ONE-PIECE  
COUPLINGS

PUSH-ON SUCTION &  
RETURN COUPLINGS

FIELD ATTACHABLE  
COUPLINGS

HYDRAULIC FITTINGS  
ACCESSORIES

# HYDRAULIC FITTINGS ACCESSORIES

## SAE ADAPTORS

SAE FLANGE CLAMPS	S40	S42	S140	S142
-------------------	-----	-----	------	------

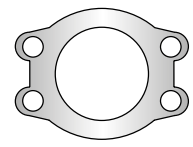
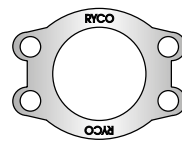
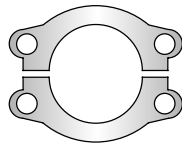
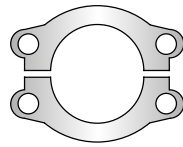

NOMINAL FLANGE	DASH SIZE	SPLIT FLANGE CLAMPS CODE 61 SUPPLIED IN PAIRS	SPLIT FLANGE CLAMPS CODE 62 SUPPLIED IN PAIRS	SOLID FLANGE CLAMP CODE 61	SOLID FLANGE CLAMP CODE 62
inch		PART NO	PART NO	PART NO	PART NO
1/2	-08	S40-08	S42-08	S140-08	S142-08
3/4	-12	S40-12	S42-12	S140-12	S142-12
1	-16	S40-16	S42-16	S140-16	S142-16
1.1/4	-20	S40-20	S42-20	S140-20	S142-20
1.1/2	-24	S40-24	S42-24	S140-24	S142-24
2	-32	S40-32	S42-32	S140-32	S142-32
2.1/2	-40	S40-40		S140-40	
3	-48	S40-48		S140-48	
4	-64	S40-64		S140-64	

SAE FLANGE CLAMP KITS - UNC BOLTS	S40K	S42K	S140K	S142K
-----------------------------------	------	------	-------	-------

WITH O RING, BOLTS & WASHERS

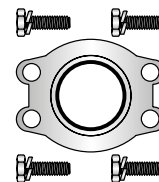
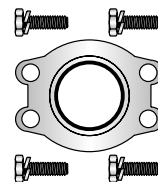
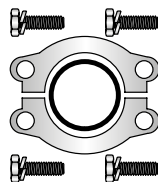
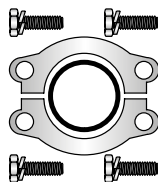

NOMINAL FLANGE	DASH SIZE	UNC BOLTS SPLIT FLANGE CLAMP KITS CODE 61	UNC BOLTS SPLIT FLANGE CLAMP KITS CODE 62	UNC BOLTS SOLID FLANGE CLAMP KITS CODE 61	UNC BOLTS SOLID FLANGE CLAMP KITS CODE 62
inch		PART NO	PART NO	PART NO	PART NO
1/2	-08	S40K-08	S42K-08	S140K-08	S142K-08
3/4	-12	S40K-12	S42K-12	S140K-12	S142K-12
1	-16	S40K-16	S42K-16	S140K-16	S142K-16
1.1/4	-20	S40K-20	S42K-20	S140K-20	S142K-20
1.1/2	-24	S40K-24	S42K-24	S140K-24	S142K-24
2	-32	S40K-32	S42K-32	S140K-32	S142K-32
2.1/2	-40	S40K-40		S140K-40	

SAE FLANGE CLAMP KITS - METRIC BOLTS	S40M	S42M	S140M	S142M
--------------------------------------	------	------	-------	-------

WITH O RING, BOLTS & WASHERS

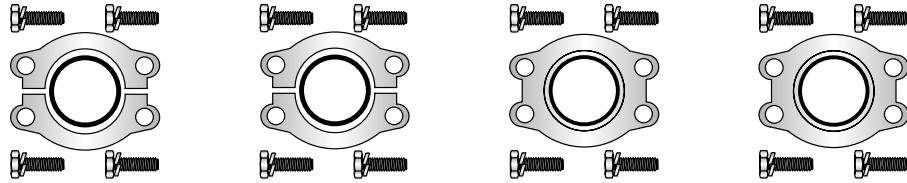

NOMINAL FLANGE	DASH SIZE	METRIC BOLTS SPLIT FLANGE CLAMP KITS CODE 61	METRIC BOLTS SPLIT FLANGE CLAMP KITS CODE 62	METRIC BOLTS SOLID FLANGE CLAMP KITS CODE 61	METRIC BOLTS SOLID FLANGE CLAMP KITS CODE 62
inch		PART NO	PART NO	PART NO	PART NO
1/2	-08	S40M-08	S42M-08	S140M-08	S142M-08
3/4	-12	S40M-12	S42M-12	S140M-12	S142M-12
1	-16	S40M-16	S42M-16	S140M-16	S142M-16
1.1/4	-20	S40M-20	S42M-20	S140M-20	S142M-20
1.1/2	-24	S40M-24	S42M-24	S140M-24	S142M-24
2	-32	S40M-32	S42M-32	S140M-32	S142M-32
2.1/2	-40	S40M-40		S140M-40	

DIMENSIONS OF SAE FLANGES & FLANGE CLAMPS

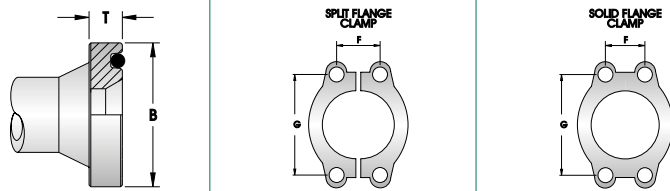

NOM. FLANGE	DASH SIZE	BØ		T		F		G		PORT THREAD & BOLT LENGTH			
		mm	inch	mm	inch	mm	inch	mm	inch	PORT	BOLT	PORT	BOLT
<b>CODE 61</b>													
1/2	-08	30,2	1.19	6,73	0.265	17,5	0.69	38,1	1.50	5/16 - 18	1.1/4	M8 X 1,25	35
*5/8	-10	34,0	1.34	6,73	0.265	19,8	0.78	42,9	1.69	5/16 - 18	1.1/4	M8 X 1,25	35
3/4	-12	38,1	1.50	6,73	0.265	22,2	0.88	47,6	1.88	3/8 - 16	1.1/4	M10 X 1,5	35
1	-16	44,5	1.75	8,00	0.315	26,2	1.03	52,4	2.06	3/8 - 16	1.1/4	M10 X 1,5	35
1.1/4	-20	50,8	2.00	8,00	0.315	30,2	1.19	58,7	2.31	7/16 - 14	1.1/2	M10 X 1,5	40
1.1/2	-24	60,3	2.38	8,00	0.315	35,7	1.41	69,8	2.75	1/2 - 13	1.1/2	M12 X 1,75	45
2	-32	71,4	2.81	9,53	0.375	42,9	1.69	77,8	3.06	1/2 - 13	1.1/2	M12 X 1,75	45
2.1/2	-40	84,1	3.31	9,53	0.375	50,8	2.00	88,9	3.50	1/2 - 13	1.3/4	M12 X 1,75	45
3	-48	101,6	4.00	9,53	0.375	61,9	2.44	106,4	4.19	5/8 - 11	1.3/4	M16 X 2,0	45

<b>CODE 62</b>													
1/2	-08	31,7	1.25	7,75	0.305	18,2	0.72	40,5	1.59	5/16 - 18	1.1/4	M8 X 1,25	35
3/4	-12	41,3	1.63	8,76	0.345	23,8	0.94	50,8	2.00	3/8 - 16	1.1/2	M10 X 1,5	40
1	-16	47,6	1.88	9,53	0.375	27,8	1.09	57,2	2.25	7/16 - 14	1.3/4	M12 X 1,75	45
1.1/4	-20	54,0	2.12	10,29	0.405	31,8	1.25	66,7	2.63	1/2 - 13	1.3/4	M14 X 2,0	45
1.1/2	-24	63,5	2.50	12,57	0.495	36,5	1.44	79,4	3.13	5/8 - 11	2.1/4	M16 X 2,0	60
2	-32	79,4	3.13	12,57	0.495	44,5	1.75	96,8	3.8 1	3/4 - 10	2.3/4	M20X 2,5	70

\*NOTE: 5/8 is used by Komatsu.

INTRODUCTION

INDEXES

ONE-PIECE COUPLINGS

PUSH-ON SUCTION & RETURN COUPLINGS

FIELD ATTACHABLE COUPLINGS

HYDRAULIC FITTINGS ACCESSORIES

# HYDRAULIC FITTINGS ACCESSORIES

## SAE ADAPTORS

SAE FLANGE	S979	S980
------------	------	------

**BLANK PLUG**  
O RING NOT SUPPLIED



NOMINAL FLANGE	DASH SIZE	BLANK PLUG CODE 61	BLANK PLUG CODE 62
inch		PART NO	PART NO
1/2	-08	S979-08	S980-08
3/4	-12	S979-12	S980-12
1	-16	S979-16	S980-16
1.1/4	-20	S979-20	S980-20
1.1/2	-24	S979-24	S980-24
2	-32	S979-32	S980-32
2.1/2	40	S979-40	

**NOTE:** Flat Face side will seal against O Ring port. O Ring side will seal against Flat Face port.  
O Ring not supplied.  
**FLANGE OD** can be found on page 275, **CLAMPS** can be found on page 274.

SAE FLANGE	S981	S982	S982C
------------	------	------	-------

**TUBE WELD**  
**\*(5/8 KOMATSU)**  
O RING NOT SUPPLIED

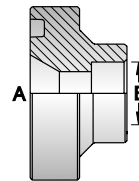
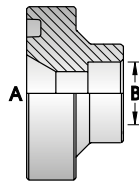
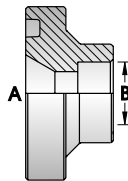

NOM. FLANGE A	TUBE OD B	DASH SIZE	CODE 61 O RING FACE SOCKET WELD	CODE 62 O RING FACE SOCKET WELD	RYCO CODE 62C O RING FACE SOCKET WELD
inch	inch		PART NO	PART NO	PART NO
1/2	5/8	-0810	<b>S981-0810</b>		
*5/8	5/8	-1010	<b>S981-1010</b>		
3/4	5/8	-1210	<b>S981-1210</b>		
3/4	3/4	-1212	<b>S981-1212</b>	<b>S982-1212</b>	<b>S982C-1212</b>
3/4	1	-1216		<b>S982-1216</b>	
1	3/4	-1612	<b>S981-1612</b>	<b>S982-1612</b>	<b>S982C-1612</b>
1	1	-1616	<b>S981-1616</b>	<b>S982-1616</b>	<b>S982C-1616</b>
1	1.1/4	-1620	<b>S981-1620</b>		
1.1/4	1	-2016	<b>S981-2016</b>	<b>S982-2016</b>	<b>S982C-2016</b>
1.1/4	1.1/4	-2020	<b>S981-2020</b>	<b>S982-2020</b>	<b>S982C-2020</b>
1.1/4	1.1/2	-2024	<b>S981-2024</b>		
1.1/2	1.1/4	-2420	<b>S981-2420</b>	<b>S982-2420</b>	<b>S982C-2420</b>
1.1/2	1.1/2	-2424	<b>S981-2424</b>	<b>S982-2424</b>	<b>S982C-2424</b>
2	1.1/4	-3220	<b>S981-3220</b>		
2	1.1/2	-3224	<b>S981-3224</b>	<b>S982-3224</b>	
2	2	-3232	<b>S981-3232</b>	<b>S982-3232</b>	
2.1/2	2	-4032	<b>S981-4032</b>		
2.1/2	2.1/2	-4040	<b>S981-4040</b>		

**NOTE:** **FLANGE OD** can be found on page 275, **CLAMPS** can be found on page 274.

SAE FLANGE/JIC	S1	S3	S2	S2L
----------------	----	----	----	-----

**CODE 61**  
O RING NOT SUPPLIED

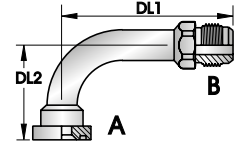
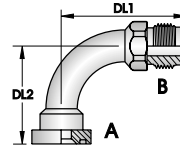
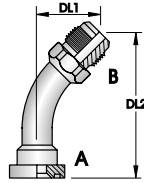
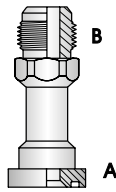

NOM. FLANGE A	THREAD B	DASH SIZE	CODE 61 FLANGE JIC MALE		CODE 61 FLANGE JIC MALE 45° TUBE BEND		CODE 61 FLANGE JIC MALE 90° TUBE BEND			CODE 61 FLANGE JIC MALE 90° LONG BEND		
			PART NO	PART NO	DL1	DL2	PART NO	DL1	DL2	PART NO	DL1	DL2
inch	inch											
1/2	3/4	-0812	S1-0812	S3-0812	32	61	S2-0812	58	41			
1/2	7/8	-0814					S2-0814	68	46			
3/4	3/4	-1212	S1-1212				S2-1212	57	46			
3/4	7/8	-1214	S1-1214	S3-1214	38	71	S2-1214	66	50			
3/4	1.1/16	-1217	S1-1217	S3-1217	41	82	S2-1217	75	56			
1	1.1/16	-1617	S1-1617	S3-1617	46	85	S2-1617	78	61			
1	1.5/16	-1621	S1-1621	S3-1621	46	94	S2-1621	88	66	S2L-1621	116	66
1.1/4	1.1/16	-2017					S2-2017	77	62			
1.1/4	1.5/16	-2021	S1-2021	S3-2021	48	96	S2-2021	89	69			
1.1/4	1.5/8	-2026	S1-2026	S3-2026	53	110	S2-2026	104	81			
1.1/2	1.5/16	-2421	S1-2421				S2-2421	87	74			
1.1/2	1.5/8	-2426	S1-2426	S3-2426	55	113	S2-2426	100	86			
1.1/2	1.7/8	-2430	S1-2430	S3-2430	67	125	S2-2430	127	93			
2	1.5/8	-3226					S2-3226	106	88			
2	1.7/8	-3230	S1-3220									
2	2.1/2	-3240					S2-3240	152	125			

**NOTE:** Drop Lengths (DL) dimensions are in millimetres.  
**FLANGE OD** can be found on page 275, **CLAMPS** can be found on page 274.

SAE FLANGE/JIC	S1H	S3H	S2H
----------------	-----	-----	-----

**CODE 62**  
O RING NOT SUPPLIED

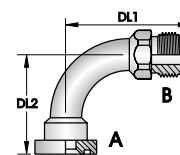
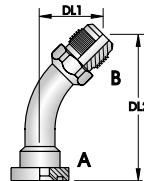
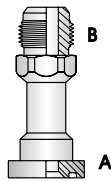

NOM. FLANGE A	THREAD B	DASH SIZE	CODE 62 FLANGE JIC MALE		CODE 62 FLANGE JIC MALE 45° TUBE BEND		CODE 62 FLANGE JIC MALE 90° TUBE BEND		
			PART NO	PART NO	DL1	DL2	PART NO	DL1	DL2
inch	inch								
3/4	7/8	-1214					S2H-1214	66	52
3/4	1.1/16	-1217	S1H-1217	S3H-1217	48	82	S2H-1217	79	55
3/4	1.5/16	-1221					S2H-1221	83	55
1	1.1/16	-1617	S1H-1617				S2H-1617	78	60
1	1.5/16	-1621	S1H-1621	S3H-1621	50	95	S2H-1621	87	69
1.1/4	1.1/16	-2017					S2H-2017	76	66
1.1/4	1.5/16	-2021	S1H-2021						
1.1/4	1.5/8	-2026					S2H-2026	105	79
1.1/2	1.5/16	-2421	S1H-2421				S2H-2421	77	90
1.1/2	1.5/8	-2426	S1H-2426				S2H-2426	102	88
2	2.1/2	-3240					S2H-3240	149	131

**NOTE:** Drop Lengths (DL) dimensions are in millimetres.  
**FLANGE OD** can be found on page 275, **CLAMPS** can be found on page 274

INTRODUCTION

INDEXES

ONE-PIECE COUPLINGS

PUSH-ON SUCTION & RETURN COUPLINGS

FIELD ATTACHABLE COUPLINGS

HYDRAULIC FITTINGS ACCESSORIES

# HYDRAULIC FITTINGS ACCESSORIES

## SAE ADAPTORS

SAE FLANGE/ORFS	S147H	S146H	S143H
-----------------	-------	-------	-------

CODE 62  
SAE FLANGE  
O RING NOT SUPPLIED

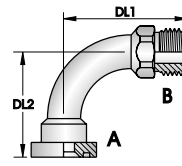
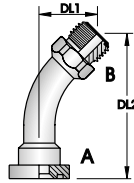
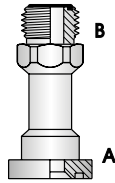

NOM. FLANGE A	THREAD B	DASH SIZE	CODE 62 FLANGE ORFS MALE	CODE 62 FLANGE ORFS MALE 45° TUBE BEND	CODE 62 FLANGE ORFS MALE 90° TUBE BEND
inch	inch		PART NO	PART NO	PART NO
1	1.7/16	-1623	S147H-1623	S146H-1623	S143H-1623
1.1/2	2	-2432			S143H-2432

NOTE: Drop Lengths (DL) dimensions are in millimetres.  
FLANGE OD can be found on page 275, CLAMPS can be found on page 274.

### ADAPTORS - SAE FLANGE BLOCKS

Ryco SAE Flange Blocks shown on pages 446 to 460 incorporate the SAE Flange Head and the SAE Flange Clamp into a single forged carbon steel unit.

Ryco SAE Flange Blocks with O Ring groove have unthreaded bolt holes.

Ryco Flat Flange blocks **S940F, S941F, S970F, S971F, S976F, S977F, S951F** and **S952F** have UNC threaded bolt holes for use with **FK61** and **FK62** Fastening Kits. (NOTE suffix "F" means Flat Face with UNC threaded bolt holes).

Ryco Flat Flange blocks **S940FM, S941FM, S970FM, S971FM, S951FM** and **S952FM** have METRIC threaded bolt holes for use with **FK61M** and **FK62M** Fastening Kits. (NOTE suffix "FM" means Flat Face with METRIC threaded bolt holes).

FOR DIMENSIONS OF SAE FLANGE BLOCKS, SEE PAGE <?>.

Due to restricted clearance on the neck of Socket Weld and BSPP Female Flange Blocks, Hex Head Bolts cannot be used. **FK61, FK61M, FK62** and **FK62M** Fastening Kits, which include Socket Head Cap Bolts and special Square Section Spring Washers, must be used.

Blind, Butt Weld, BSPP Male and JIC Male Flange Blocks may be used with Hex Head Bolts and standard Spring Washers if preferred.

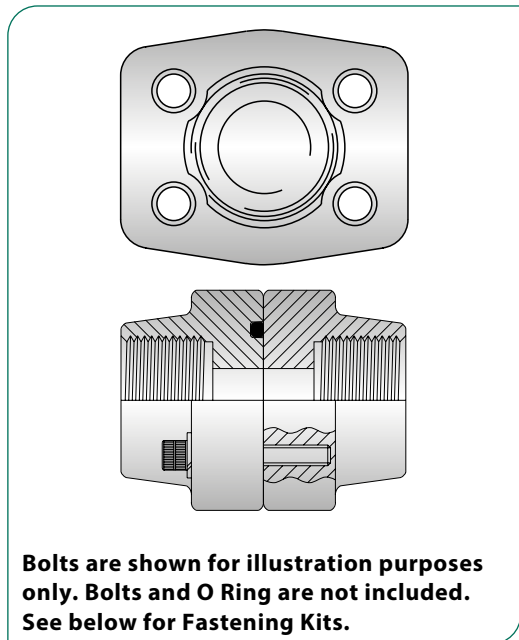

Bolts are shown for illustration purposes only. Bolts and O Ring are not included. See below for Fastening Kits.

SAE FLANGE BLOCKS	FK61	FK62	FK61M	FK62M
-------------------	------	------	-------	-------

FASTENING KITS  
WITH O RING,  
SOCKET HEAD  
CAP BOLTS  
& WASHERS

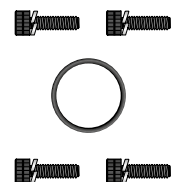
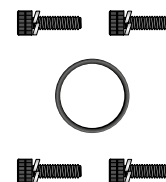
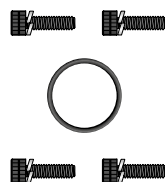
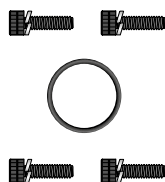

NOM. FLANGE SIZE	DASH SIZE	SUITS SAE FLANGE BLOCKS CODE 61, UNC BOLTS	SUITS SAE FLANGE BLOCKS CODE 62, UNC BOLTS	SUITS SAE FLANGE BLOCKS CODE 61, METRIC BOLTS	SUITS SAE FLANGE BLOCKS CODE 62, METRIC BOLTS
inch		PART NO	PART NO	PART NO	PART NO
1/2	-08	FK61-08	FK62-08	FK61M-08	FK62M-08
3/4	-12	FK61-12	FK62-12	FK61M-12	FK62M-12
1	-16	FK61-16	FK62-16	FK61M-16	FK62M-16
1.1/4	-20	FK61-20	FK62-20	FK61M-20	FK62M-20
1.1/2	-24	FK61-24	FK62-24	FK61M-24	FK62M-24
2	-32	FK61-32	FK62-32	FK61M-32	FK62M-32

## SAE FLANGE BLOCKS

### SAE FLANGE BLOCKS      S967      S968

**BLIND BLANKING FLANGE**  
O RING & BOLTS NOT SUPPLIED

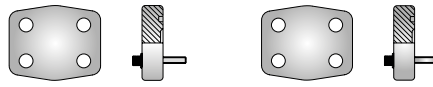

NOM. FLANGE SIZE	DASH SIZE	CODE 61 FLANGE BLIND	CODE 62 FLANGE BLIND
inch		PART NO	PART NO
1/2	-08	S967-08	S968-08
3/4	-12	S967-12	S968-12
1	-16	S967-16	S968-16
1.1/4	-20	S967-20	S968-20
1.1/2	-24	S967-24	S968-24
2	-32	S967-32	S968-32

### SAE FLANGE BLOCKS      S940      S940F      S940FM

**CODE 61 SOCKET WELD TO SUIT IMPERIAL TUBE**  
O RING & BOLTS NOT SUPPLIED

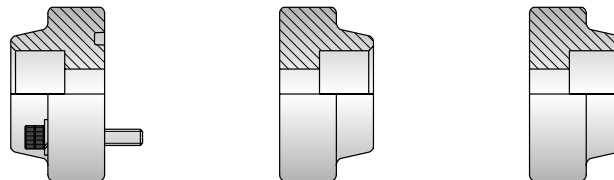

NOM. FLANGE SIZE	NOM. TUBE SIZE	DASH SIZE	TO SUIT TUBE OD	CODE 61 FLANGE SOCKET WELD TUBE	CODE 61 FLANGE FLAT SOCKET WELD TUBE UNC BOLT HOLES	CODE 61 FLANGE FLAT SOCKET WELD TUBE METRIC BOLT HOLES
inch	inch		mm	PART NO	PART NO	PART NO
1/2	1/2	-0808	12,7	S940-0808	S940F-0808	S940FM-0808
3/4	3/4	-1212	19,1	S940-1212	S940F-1212	S940FM-1212
1	1	-1616	25,4	S940-1616	S940F-1616	S940FM-1616
1.1/4	1.1/4	-2020	31,8	S940-2020	S940F-2020	S940FM-2020
1.1/2	1.1/2	-2424	38,1	S940-2424	S940F-2424	S940FM-2424
2	2	-3232	50,8	S940-3232	S940F-3232	S940FM-3232

### SAE FLANGE BLOCKS      S941      S941F      S941FM

**CODE 62 SOCKET WELD TO SUIT IMPERIAL TUBE**  
O RING & BOLTS NOT SUPPLIED

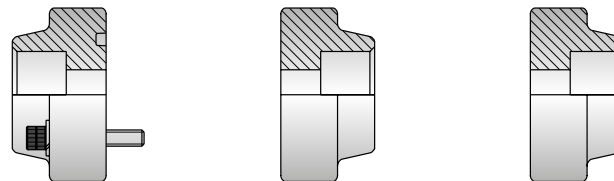

NOM. FLANGE SIZE	NOM. TUBE SIZE	DASH SIZE	TO SUIT TUBE OD	CODE 62 FLANGE SOCKET WELD TUBE	CODE 62 FLANGE FLAT SOCKET WELD TUBE UNC BOLT HOLES	CODE 62 FLANGE FLAT SOCKET WELD TUBE METRIC BOLT HOLES
inch	inch		mm	PART NO	PART NO	PART NO
3/4	3/4	-1212	19,1	S941-1212	S941F-1212	S941FM-1212
1	1	-1616	25,4	S941-1616	S941F-1616	S941FM-1616
1.1/4	1.1/4	-2020	31,8	S941-2020	S941F-2020	S941FM-2020
1.1/2	1.1/2	-2424	38,1	S941-2424	S941F-2424	S941FM-2424
2	2	-3232	50,8	S941-3232	S941F-3232	S941FM-3232

**NOTE:** Bolts are shown for illustration purposes only. Bolts and O Ring are not included.

# HYDRAULIC FITTINGS ACCESSORIES

## SAE FLANGE BLOCKS

### SAE FLANGE BLOCKS      S970      S970F      S970FM

**CODE 61**  
**SOCKET WELD TO SUIT**  
**IMPERIAL PIPE**  
 O RING & BOLTS NOT SUPPLIED

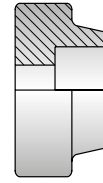
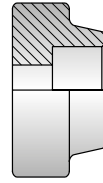
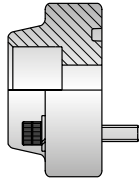

NOM. FLANGE SIZE	NOM. PIPE SIZE	DASH SIZE	TO SUIT PIPE OD	CODE 61 FLANGE SOCKET WELD PIPE	CODE 61 FLANGE FLAT SOCKET WELD PIPE UNC BOLT HOLES	CODE 61 FLANGE FLAT SOCKET WELD PIPE METRIC BOLT HOLES
inch	inch		mm	PART NO	PART NO	PART NO
1/2	1/2	-0808	21,3	S970-0808	S970F-0808	S970FM-0808
3/4	3/4	-1212	26,7	S970-1212	S970F-1212	S970FM-1212
1	1	-1616	33,4	S970-1616	S970F-1616	S970FM-1616
1.1/4	1.1/4	-2020	42,2	S970-2020	S970F-2020	S970FM-2020
1.1/2	1.1/2	-2424	48,3	S970-2424	S970F-2424	S970FM-2424
2	2	-3232	60,3	S970-3232	S970F-3232	S970FM-3232

### SAE FLANGE BLOCKS      S971      S971F      S971FM

**CODE 62**  
**SOCKET WELD TO SUIT**  
**IMPERIAL PIPE**  
 O RING & BOLTS NOT SUPPLIED

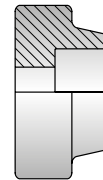
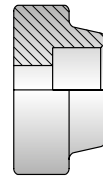
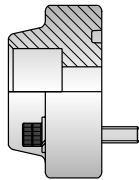

NOM. FLANGE SIZE	NOM. PIPE SIZE	DASH SIZE	TO SUIT PIPE OD	CODE 62 FLANGE SOCKET WELD PIPE	CODE 62 FLANGE FLAT SOCKET WELD PIPE UNC BOLT HOLES	CODE 62 FLANGE FLAT SOCKET WELD PIPE METRIC BOLT HOLES
inch	inch		mm	PART NO	PART NO	PART NO
3/4	3/4	-1212	26,7	S971-1212	S971F-1212	S971FM-1212
1	1	-1616	33,4	S971-1616	S971F-1616	S971FM-1616
1.1/4	1.1/4	-2020	42,2	S971-2020	S971F-2020	S971FM-2020
1.1/2	1.1/2	-2424	48,3	S971-2424	S971F-2424	S971FM-2424
2	2	-3232	60,3	S971-3232	S971F-3232	S971FM-3232

### SAE FLANGE BLOCKS      S976      S976F      S977      S977F

**BUTT WELD TO SUIT**  
**IMPERIAL PIPE**  
 O RING & BOLTS NOT SUPPLIED

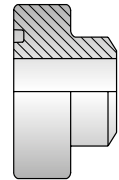
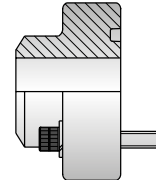
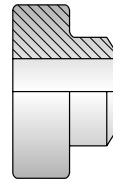
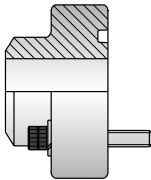

NOM. FLANGE SIZE	NOM. PIPE SIZE	DASH SIZE	TO SUIT PIPE OD	CODE 61 FLANGE BUTT WELD PIPE	CODE 61 FLANGE FLAT BUTT WELD PIPE UNC BOLT HOLES	CODE 62 FLANGE BUTT WELD PIPE	CODE 62 FLANGE FLAT BUTT WELD PIPE UNC BOLT HOLES
inch	inch		mm	PART NO	PART NO	PART NO	PART NO
1/2	1/2	-0808	21,3	S976-0808	S976F-0808	S977-0808	S977F-0808
3/4	3/4	-1212	26,7	S976-1212	S976F-1212	S977-1212	S977F-1212
1	1	-1616	33,4	S976-1616	S976F-1616	S977-1616	S977F-1616
1.1/4	1.1/4	-2020	42,2	S976-2020	S976F-2020	S977-2020	S977F-2020
1.1/2	1.1/2	-2424	48,3	S976-2424	S976F-2424	S977-2424	S977F-2424
2	2	-3232	60,3	S976-3232	S976F-3232	S977-3232	S977F-3232

**NOTE:** Bolts are shown for illustration purposes only. Bolts and O Ring are not included.

## SAE FLANGE BLOCKS

### SAE FLANGE BLOCKS      **S951**      **S951F**      **S951FM**

**CODE 61  
BSPP FEMALE**  
O RING & BOLTS NOT SUPPLIED

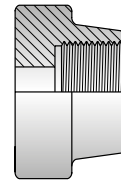
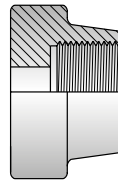
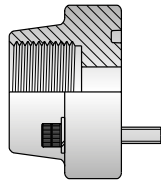

NOM. FLANGE SIZE	THREAD SIZE	DASH SIZE	CODE 61 FLANGE BSPP FEMALE	CODE 61 FLANGE FLAT BSPP FEMALE UNC BOLT HOLES	CODE 61 FLANGE FLAT BSPP FEMALE METRIC BOLT HOLES
inch	inch		PART NO	PART NO	PART NO
1/2	1/2	-0808	S951-0808	S951F-0808	S951FM-0808
3/4	3/4	-1212	S951-1212	S951F-1212	S951FM-1212
1	1	-1616	S951-1616	S951F-1616	S951FM-1616
1.1/4	1.1/4	-2020	S951-2020	S951F-2020	S951FM-2020
1.1/2	1.1/2	-2424	S951-2424	S951F-2424	S951FM-2424
2	2	-3232	S951-3232	S951F-3232	S951FM-3232

### SAE FLANGE BLOCKS      **S952**      **S952F**      **S952FM**

**CODE 62  
BSPP FEMALE**  
O RING & BOLTS NOT SUPPLIED

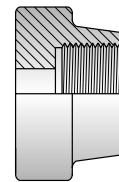
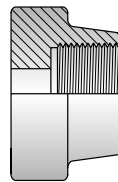
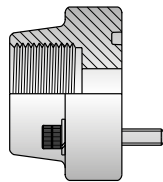

NOM. FLANGE SIZE	THREAD SIZE	DASH SIZE	CODE 62 FLANGE BSPP FEMALE	CODE 62 FLANGE FLAT BSPP FEMALE UNC BOLT HOLES	CODE 62 FLANGE FLAT BSPP FEMALE METRIC BOLT HOLES
inch	inch		PART NO	PART NO	PART NO
3/4	3/4	-1212	S952-1212	S952F-1212	S952FM-1212
1	1	-1616	S952-1616	S952F-1616	S952FM-1616
1.1/4	1.1/4	-2020	S952-2020	S952F-2020	S952FM-2020
1.1/2	1.1/2	-2424	S952-2424	S952F-2424	S952FM-2424
2	2	-3232	S952-3232	S952F-3232	S952FM-3232

### SAE FLANGE BLOCKS      **S953**      **S954**

**BSPP MALE**  
O RING & BOLTS NOT SUPPLIED

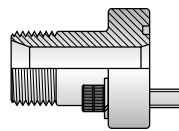
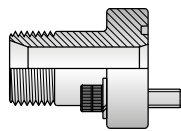

NOM. FLANGE SIZE	THREAD SIZE	DASH SIZE	CODE 61 FLANGE BSPP MALE	CODE 62 FLANGE BSPP MALE
inch	inch		PART NO	PART NO
1/2	1/2	-0808	S953-0808	S954-0808
3/4	3/4	-1212	S953-1212	S954-1212
1	1	-1616	S953-1616	S954-1616
1.1/4	1.1/4	-2020	S953-2020	S954-2020
1.1/2	1.1/2	-2424	S953-2424	S954-2424

**NOTE:** Bolts are shown for illustration purposes only. Bolts and O Ring are not included.

INTRODUCTION

INDEXES

ONE-PIECE COUPLINGS

PUSH-ON SUCTION & RETURN COUPLINGS

FIELD ATTACHABLE COUPLINGS

HYDRAULIC FITTINGS ACCESSORIES

# HYDRAULIC FITTINGS ACCESSORIES

## SAE ADAPTORS

<b>SAE FLANGE BLOCKS</b>	<b>S957</b>	<b>S958</b>
--------------------------	-------------	-------------

### JIC MALE

O RING & BOLTS NOT SUPPLIED

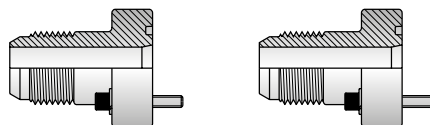

NOM. FLANGE SIZE	THREAD SIZE	DASH SIZE	CODE 61 FLANGE JIC MALE	CODE 62 FLANGE JIC MALE
inch	inch		PART NO	PART NO
1/2	3/4	-0812	S957-0812	S958-0812
3/4	1.1/16	-1217	S957-1217	S958-1217
1	1.5/16	-1621	S957-1621	S958-1621
1.1/4	1.5/8	-2026	S957-2026	S958-2026
1.1/2	1.7/8	-2430	S957-2430	S958-2430

**NOTE:** Bolts are shown for illustration purposes only. Bolts and O Ring are not included.

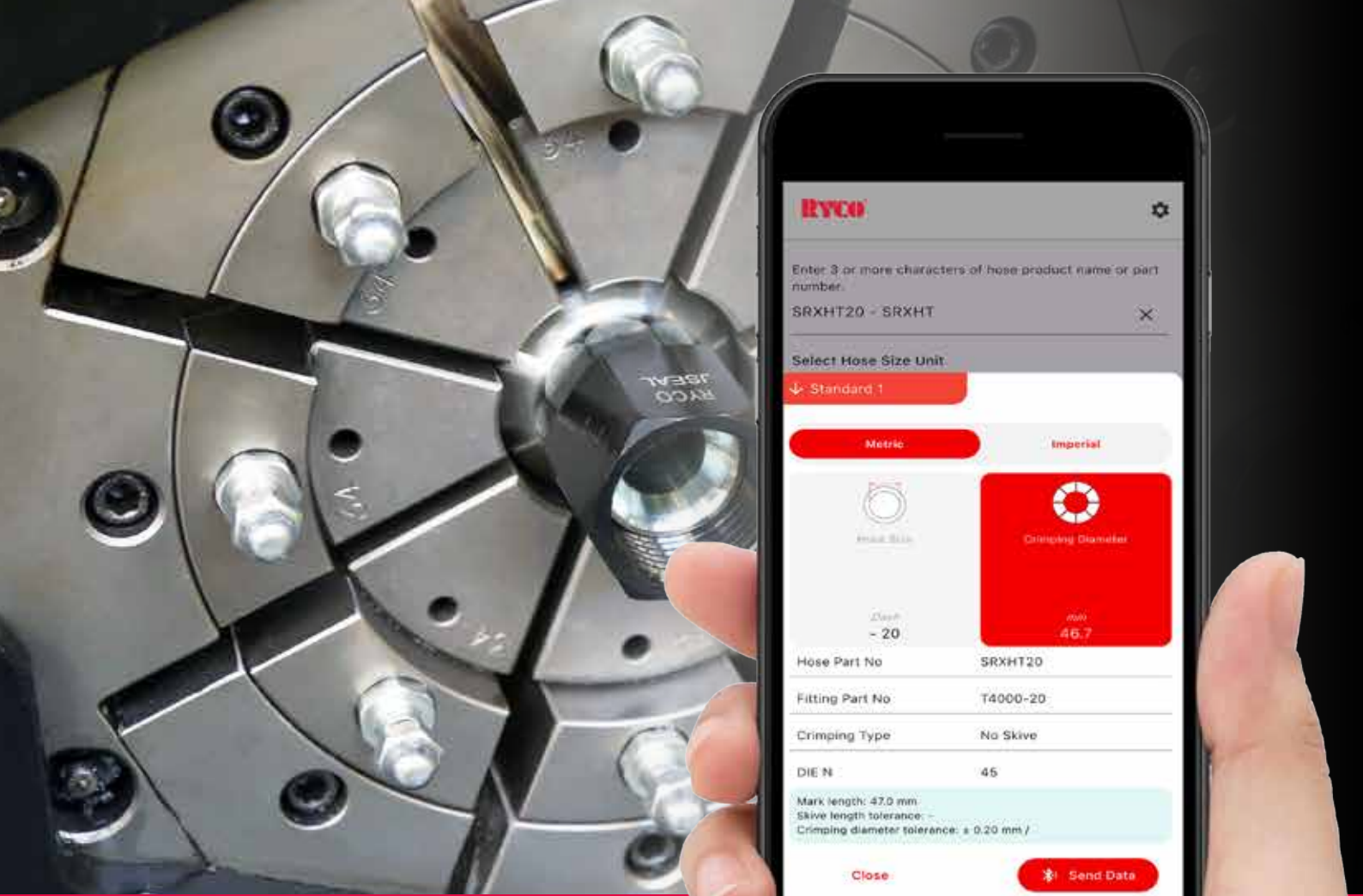

# RYCO<sup>®</sup> CRIMP

## YOUR SOURCE FOR THE MOST UP TO DATE CRIMP SETTINGS

Stay up-to-date with Ryco's Crimp App, your go-to resource for accurate, efficient, and safe hydraulic hose crimping. Designed with professionals in mind, this innovative app grants instant access to the latest crimp specifications, ensuring precision, and reliability in every assembly.

Whether in the workshop or on the go, the Ryco Crimp App provides real-time access to an extensive database of hose and fitting specifications, helping to reduce downtime and boost productivity. With seamless Bluetooth integration, users can connect to compatible devices for an even more streamlined experience.

### Key Features of the Ryco Crimp App:

- Instant Access: to the latest Ryco crimp specifications.
- Bluetooth Integration: for seamless connectivity.
- Easy-to-Use Interface: for quick navigation.

### Download the Ryco Crimp App Now!

Enhance your workflow and reduce downtime with the Ryco Crimp App, download it today!



[www.ryco-hydraulics.com](http://www.ryco-hydraulics.com)

<b>T2000 SERIES.....</b>	<b>21</b>	T2813.....	57	T4660.....	88	T6170.....	113	T7250.....	140
T2010.....	21	T2814.....	57	T4670.....	88	T6330.....	114	T7251.....	141
T2013.....	22	T2810.....	58	T4501.....	89	T6333.....	114	T7243.....	141
T2017.....	23	T2811.....	58	T4840.....	89	T6334.....	115	T7244.....	141
T2020.....	23	T2823.....	59	T4800.....	90	T6335.....	115	T7240.....	142
T2320.....	24	T2824.....	59	T4801.....	90	T6912.....	116	T7241.....	142
T2340.....	24	T2820.....	59	T4810.....	91	T6440.....	116	T7245.....	143
T2028B.....	24	T2821.....	61	T4811.....	91	T6445.....	116	T7280.....	143
T2024.....	25	T2830.....	61	T4820.....	92	T6443.....	117	T7044.....	143
T2060.....	25	T2831.....	62	T4821.....	92	T6444.....	117	T7122.....	144
T2475.....	25	T2940.....	62	T4830.....	92	T6450.....	118	T7680.....	144
T2050.....	26	T2950.....	62	T4530.....	93	T6453.....	118	T7900.....	145
T2270.....	26	T2870.....	63	T4540.....	93	T6454.....	119	T7501.....	145
T2260.....	27	T2871.....	63	T4570.....	93	T6455.....	119	T7510.....	145
T2210.....	27	T2872.....	64	T4550.....	94	T6353.....	120	T7520.....	146
T2027.....	28	T2480.....	64	T4560.....	94	T6354.....	121	T7630.....	146
T2057.....	28	T2482.....	65	T4740.....	94	T6355.....	121	T7711.....	146
T2277.....	29	T2483.....	65	T4750.....	95	T6359.....	122	T7720.....	147
T2267.....	29	T2530.....	66	T4770.....	95	T6465.....	122	T7730.....	147
T2090.....	30	T2540.....	66	T4870.....	96	T6360.....	122	T7840.....	148
T2091.....	30	T2580.....	67	T4130.....	96	T6914.....	123	T7800.....	148
T2320N.....	31	T2570.....	67	T4150.....	97	T6916.....	123	T7801.....	149
T2340N.....	31	T2740.....	67	T4170.....	97	T6918.....	123	T7810.....	149
T2190.....	32	T2780.....	68	T4173.....	97	T6363.....	124	T7811.....	150
T2020N.....	32	T2790.....	68	T4200.....	98	T6364.....	124	T7823.....	150
T2861.....	33	T2750.....	68	T4230.....	98	T6374.....	125	T7824.....	150
T2030.....	33	T2760.....	69	T4850.....	99	T6460.....	125	T7820.....	151
T2031.....	34	T2770.....	69	<b>T6000 SERIES.....</b>	<b>100</b>	T6463.....	126	T7821.....	151
T2040.....	35	T2130.....	70	T6010.....	100	T6464.....	126	T7830.....	152
T2041.....	36	T2150.....	71	T6013.....	100	T6375.....	127	T7831.....	152
T2080.....	36	T2170.....	72	T6020.....	101	T6370.....	127	T7870.....	152
T2081.....	37	T2230.....	72	T6022.....	101	T6373.....	128	T7871.....	153
T2070.....	37	T2180.....	73	T6270.....	101	T6936.....	128	T7872.....	153
T2071.....	38	T2640.....	74	T6260.....	102	T6932.....	128	T7876.....	154
T2250.....	38	T2643.....	75	T6090.....	102	T6930.....	129	T7480.....	154
T2251.....	39	T2646.....	75	T6091.....	102	T6933.....	129	T7482.....	154
T2243.....	39	T2850.....	76	T6020N.....	103	T61502.....	129	T7483.....	155
T2244.....	39	T2200.....	76	T6030.....	103	T61501.....	130	T7130.....	156
T2241.....	40	T2380.....	77	T6031.....	103	<b>T7000 SERIES.....</b>	<b>131</b>	T7140.....	157
T2280.....	41	T2390.....	77	T6040.....	104	T7010.....	131	T7150.....	157
T2281.....	41	<b>T4000 SERIES.....</b>	<b>78</b>	T6045.....	104	T7014.....	131	T7300.....	158
T2220.....	42	T4010.....	78	T6250.....	104	T7013.....	132	T7290.....	158
T2122.....	42	T4013.....	78	T6280.....	105	T7020.....	132	T7160.....	159
T2680.....	43	T4320.....	79	T6240.....	105	T7022.....	133	T7170.....	159
T2682.....	43	T4020.....	79	T6900.....	105	T7060.....	133	T7171.....	160
T2683.....	44	T4340.....	79	T6630.....	106	T7050.....	133	T7172.....	160
T2900.....	44	T4050.....	80	T6711.....	106	T7270.....	134	T7173.....	160
T2650.....	45	T4260.....	80	T6720.....	106	T7260.....	134	T7174.....	161
T2600.....	46	T4090.....	81	T6730.....	107	T7210.....	135	T7910.....	161
T2660.....	46	T4320N.....	81	T6840.....	107	T7027.....	135	T7330.....	162
T2670.....	47	T4020N.....	82	T6800.....	107	T7057.....	135	T7440.....	162
T2610.....	47	T4030.....	82	T6801.....	108	T7277.....	136	T7450.....	163
T2501.....	48	T4031.....	82	T6810.....	108	T7267.....	136	T7350.....	163
T2510.....	49	T4040.....	83	T6811.....	108	T7090.....	136	T7460.....	164
T2520.....	50	T4041.....	84	T6820.....	109	T7091.....	137	T7360.....	164
T2630.....	51	T4250.....	84	T6821.....	109	T7020N.....	137	T7370.....	165
T2711.....	52	T4251.....	85	T6871.....	109	T7030.....	137	T7930.....	165
T2720.....	53	T4243.....	85	T6872.....	110	T7031.....	138	T7333.....	166
T2730.....	54	T4240.....	86	T6870.....	110	T7040.....	138	T7443.....	166
T2470.....	55	T4241.....	86	T6876.....	110	T7041.....	139	T7444.....	166
T2840.....	56	T4280.....	87	T6130.....	111	T7039.....	139	T7453.....	167
T2800.....	56	T4281.....	87	T6290.....	112	T7045.....	139	T7454.....	167
T2801.....	57	T4122.....	87	T6150.....	112	T7080.....	140	T7353.....	168
		T4600.....	88	T6300.....	113	T7070.....	140	T7354.....	168

T7463.....	169	TT250.....	194	6090 INSERT.....	223	6320N.....	249	S2L.....	277
T7464.....	169	TT251.....	195	V090 COUPLING.....	223	6030.....	250	S1H.....	277
T7363.....	170	TT240.....	195	6030 INSERT.....	224	6040.....	251	S3H.....	277
T7364.....	170	TT241.....	195	V030 COUPLING.....	224	6860.....	252	S2H.....	277
T7373.....	171	TT090.....	196	6040 INSERT.....	225	6080.....	253	S147H.....	278
T7378.....	171	TT600.....	196	V040 COUPLING.....	225	6070.....	253	S146H.....	278
T7374.....	171	TT670.....	196	6070 INSERT.....	226	6250.....	254	S143H.....	278
T7933.....	172	TT540.....	197	V070 COUPLING.....	226	6240.....	255	FK61.....	278
T7640.....	172	<b>TG000 SERIES.....</b>	<b>198</b>	6250 INSERT.....	227	6280.....	256	FK62.....	278
T7230.....	172	TG010.....	198	V250 COUPLING.....	227	6680.....	256	FK61M.....	278
T7200.....	173	TG320.....	198	6240 INSERT.....	228	6650.....	257	FK62M.....	278
T71501.....	173	TG020.....	198	V240 COUPLING.....	228	6600.....	257	S967.....	279
T71502.....	173	TG090.....	199	6280 INSERT.....	229	6660.....	258	S968.....	279
<b>TP000 SERIES.....</b>	<b>174</b>	TG320N.....	199	V280 COUPLING.....	229	6670.....	258	S940.....	279
TP010.....	174	TG020N.....	199	6800 INSERT.....	230	6630.....	259	S940F.....	279
TP020.....	174	TG030.....	200	V800 COUPLING.....	230	6711.....	259	S940FM.....	279
TP050.....	175	TG040.....	200	6810 INSERT.....	231	6720.....	260	S941.....	279
TP122.....	175	TG640.....	200	V810 COUPLING.....	231	6730.....	260	S941F.....	279
TP260.....	175	TW4027.....	201	6820 INSERT.....	231	6800.....	261	S941FM.....	279
TP270.....	176	TW4090.....	201	V820 COUPLING.....	231	6810.....	261	S970.....	280
TP475.....	176	TW4711.....	201	6830 INSERT.....	232	6820.....	262	S970F.....	280
TP090.....	177	<b>8000 SERIES.....</b>	<b>202</b>	V830 COUPLING.....	232	6830.....	262	S970FM.....	280
TP340N.....	177	8111.....	202	6530 INSERT.....	233	6530.....	263	S971.....	280
TP020N.....	178	8020.....	202	V530 COUPLING.....	233	6540.....	263	S971F.....	280
TP030.....	178	8060.....	202	6540 INSERT.....	233	6580.....	264	S971FM.....	280
TP031.....	178	8050.....	203	V540 COUPLING.....	233	6570.....	264	S976.....	280
TP040.....	179	8010.....	203	6550 INSERT.....	234	6550.....	264	S976F.....	280
TP041.....	179	8090.....	204	V550 COUPLING.....	234	6560.....	265	S977.....	280
TP250.....	180	8030.....	204	6560 INSERT.....	234	6563.....	265	S977F.....	280
TP251.....	180	8040.....	205	V560 COUPLING.....	234	6740.....	265	S951.....	281
TP240.....	181	8070.....	205	S740 INSERT.....	234	6780.....	266	S951F.....	281
TP241.....	181	8240.....	206	V740 COUPLING.....	234	6790.....	266	S951FM.....	281
TP280.....	182	8900.....	206	6750 INSERT.....	235	6750.....	266	S952.....	281
TP281.....	182	8530.....	206	V750 COUPLING.....	235	6760.....	267	S952F.....	281
TP850.....	182	8540.....	207	6770 INSERT.....	235	6770.....	267	S952FM.....	281
TP501.....	183	8570.....	207	V770 COUPLING.....	235	6150.....	268	S953.....	281
TP510.....	183	8740.....	207	6230 INSERT.....	236	6170.....	269	S954.....	281
TP520.....	184	8230.....	208	V230 COUPLING.....	236	6230.....	270	S957.....	282
TP630.....	184	8180.....	208	6200 INSERT.....	237	6180.....	270	S958.....	282
TP711.....	185	8200.....	208	V200 COUPLING.....	237	6640.....	271		
TP720.....	185	8100.....	209	6000 SERIES.....	238	6850.....	271		
TP730.....	186	8640.....	209	K000.....	238	6200.....	272		
TP470.....	186	<b>33000 SERIES.....</b>	<b>210</b>	L000.....	238	6380.....	272		
TP640.....	187	33111.....	210	M000.....	238	6390.....	273		
TP643.....	187	33410.....	211	P000.....	238	S40.....	274		
TP646.....	187	33020.....	211	K000.....	240	S42.....	274		
TP800.....	188	33024.....	212	L000.....	240	S140.....	274		
TP801.....	188	33010.....	212	M000.....	241	S142.....	274		
TP810.....	189	33400.....	213	P000.....	241	S40K.....	274		
TP811.....	189	33090.....	213	V000.....	241	S42K.....	274		
TP820.....	189	33400N.....	214	6010.....	242	S140K.....	274		
TP821.....	190	33040.....	214	6020.....	243	S142K.....	274		
TP540.....	190	33130.....	215	6320.....	244	S40M.....	275		
TP570.....	190	33150.....	216	6340.....	244	S42M.....	275		
<b>TT000 SERIES.....</b>	<b>191</b>	33170.....	216	6024.....	244	S140M.....	275		
TT010.....	191	33200.....	217	6052.....	245	S142M.....	275		
TT320.....	191	33420.....	217	6060.....	245	S979.....	276		
TT020.....	192	<b>V000 SERIES.....</b>	<b>218</b>	6050.....	246	S980.....	276		
TT050.....	192	BSPT.....	220	6270.....	246	S981.....	276		
TT260.....	192	BSPP.....	221	6260.....	247	S982.....	276		
TT030.....	193	6270 INSERT.....	222	6210.....	247	S982C.....	276		
TT031.....	193	V270 COUPLING.....	222	6090.....	248	S1.....	277		
TT040.....	194	6260 INSERT.....	222	6091.....	248	S3.....	277		
TT041.....	194	V260 COUPLING.....	222	6960B.....	249	S2.....	277		

INTRODUCTION

INDEXES

ONE-PIECE COUPLINGS

PUSH-ON SUCTION & RETURN COUPLINGS

FIELD ATTACHABLE COUPLINGS

HYDRAULIC FITTINGS ACCESSORIES

**RYCO**<sup>®</sup>

[www.ryco-hydraulics.com](http://www.ryco-hydraulics.com)



SCAN HERE FOR MORE  
CONTACT INFORMATION